

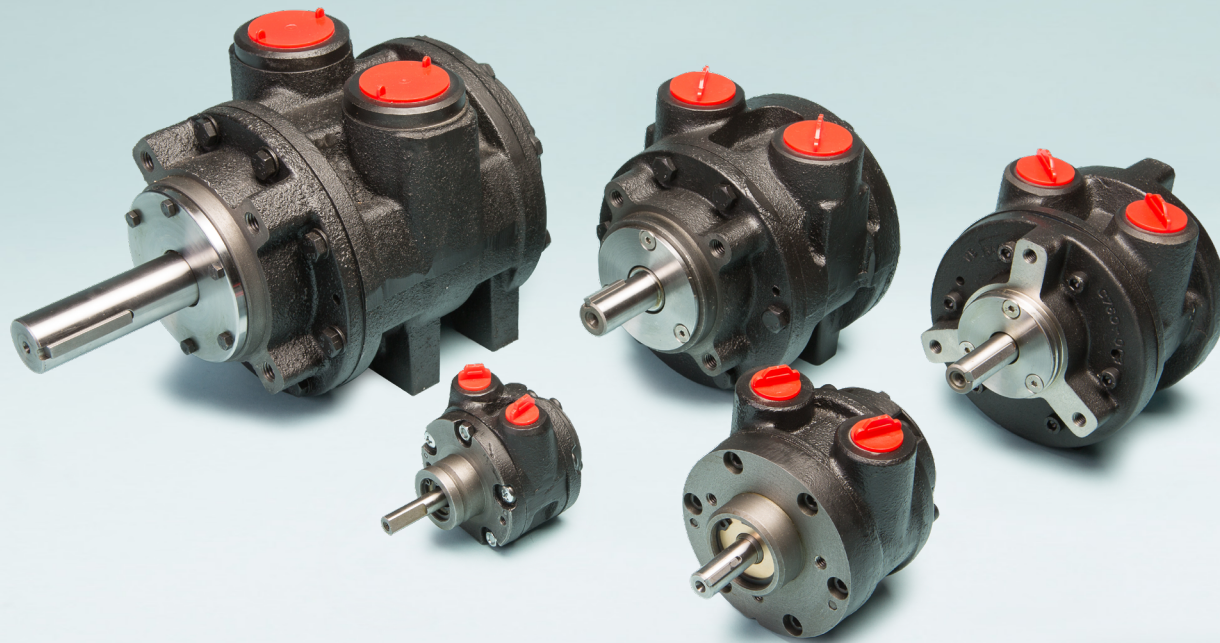

GLOBE AIRMOTORS B.V.

GLOBE Airmotors | Boerhaaveweg 9-11 | NL - 2408 AD Alphen a/d Rijn | Tel +31 172 426 608 | info@globe-benelux.nl

Specifications: VA6J&X | VS6C | VA6C Vane Air Motor



Order your
VANE AIR MOTOR:
info@globe-benelux.nl



Contents	
Performance	3
Main dimensions VA6J&X	3
Main dimensions VS6C	4
Main dimensions VA6C	4
Accessories for the V6	5

CE UK CA Ex II 2G Ex h IIC T4 Gb
II 2D Ex h IIIC T135°C Db
-20° ≤ Ta ≤ +60°C

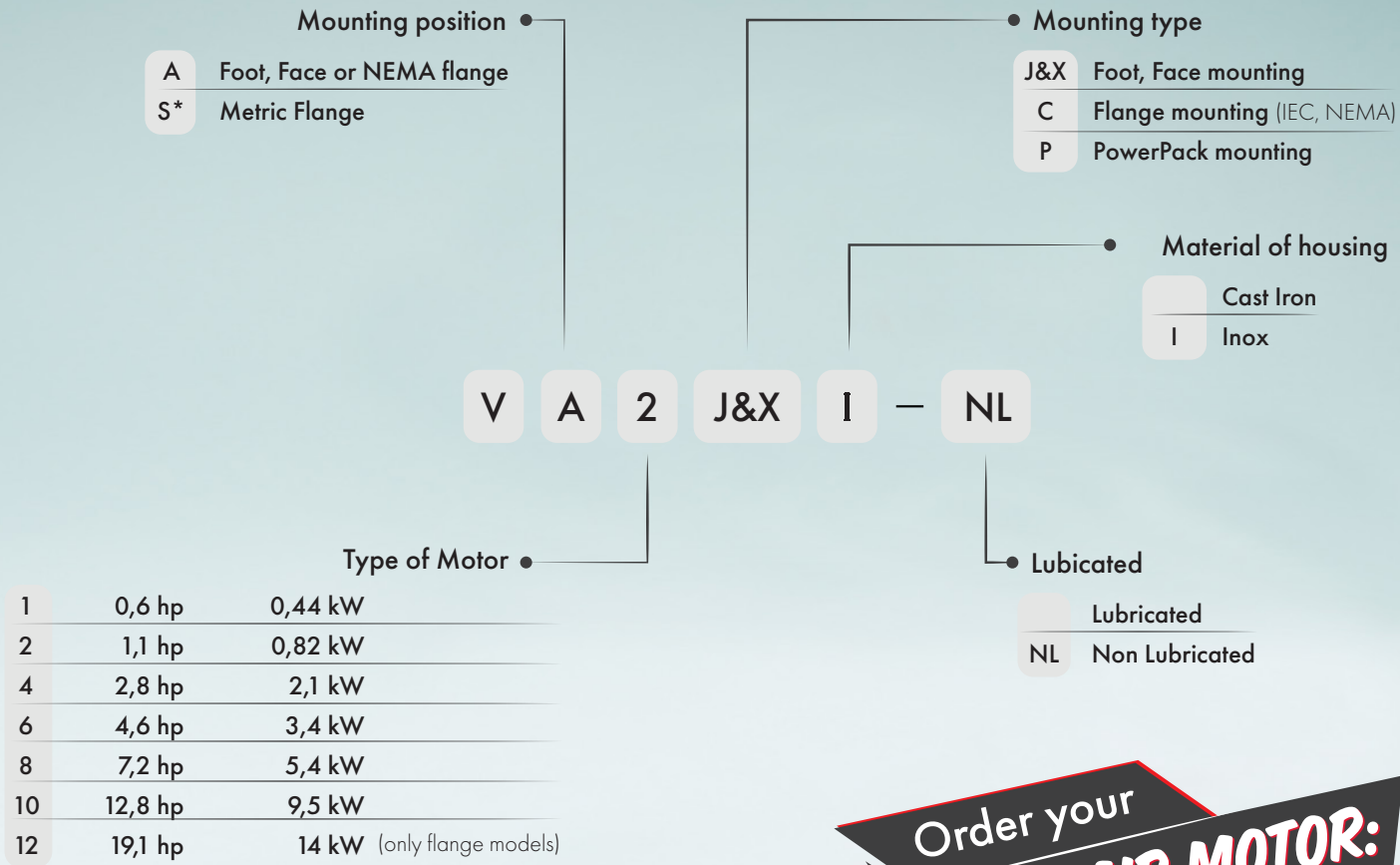
Ordering Code



All our Vane Air Motors are delivered with the ATEX Certificate:





II 2G Ex h IIC T4 Gb
II 2D Ex h IIIC T135°C Db
 -20° ≤ Ta ≤ +60°C

* The VS types are only available with mouting type C (for example VS8C).

Order your
VANE AIR MOTOR:
orders@globe-benelux.nl

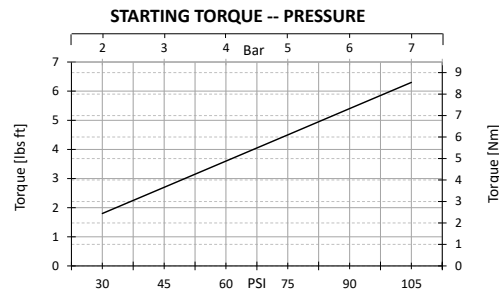
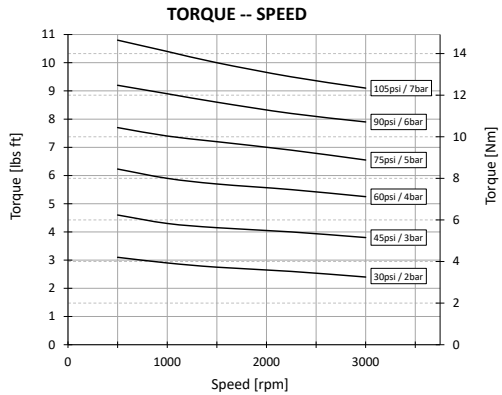
Performances V6 Vane Air Motor

VA6J&X



When designing for applications where the minimum start torque requirement is equal to the running torque (in hoists for example) the motor should be operated in the area below the starting torque.

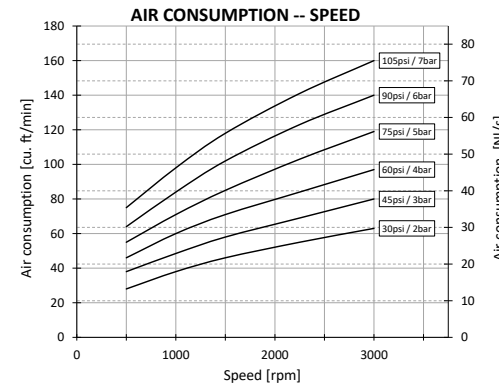
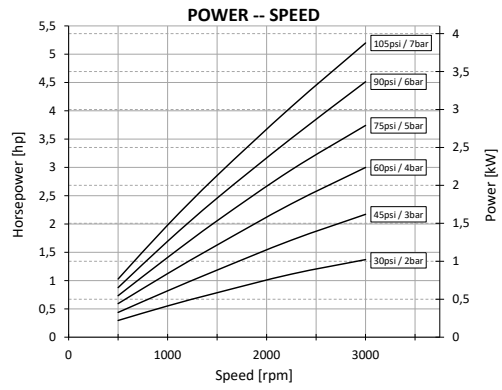

- » Silencer supplied with motor.
- » Motor is reversible.
- » Maximum temperature -20°C to +60°C (-4°F to +140°F).
- » Maximum temperature for non ATEX applications: -20°C to +80°C (-4°F to +176°F).
- » A pressure regulator should be used to control the air pressure to the motor, to limit the maximum output torque applied to the driven assembly.

Airsupply lubrication and filtration:
 Use 64 micron filtration or better. Choose a lubricator suitable for the flow required. Prior to initial startup, inject oil into the inlet port.

Lubricator drop rate 5-6 drop / minute continuous operations
 Lubricator drop rate 10-12 drop / minute intermittent operation.

Maximum speed 3000 rpm

Life time depends highly on operational speed and air pressure.

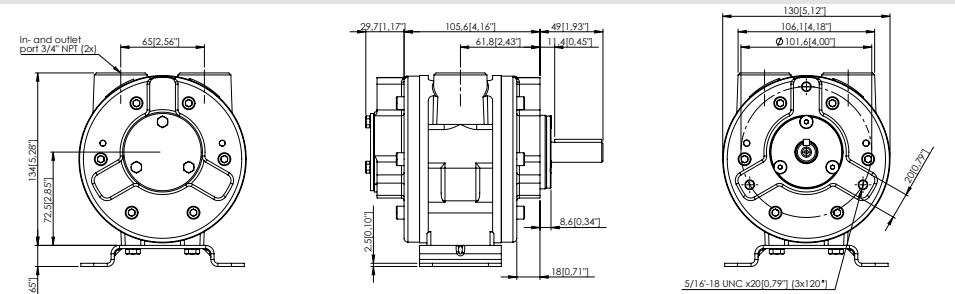

- » Maximum temperature -20°C to +60°C (-4°F to +140°F)
- » Silencer supplied with motor
- » Max. Overhung Force on shaft 300 N (70 lbf.)
- » Axial loads should be kept to a minimum
- » Mass 7.6 kg

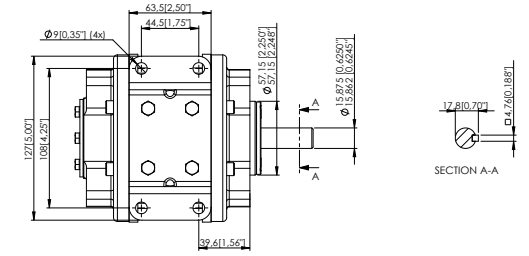

Note: With air inlet at port 'A', rotation is clockwise looking on shaft. For opposite rotation reverse ports.

Item	Part No.	Description	Qty	Kit No.
1	760-001	Body NPT	1	
2	760-003	Front plate	1	
3	760-002	Back plate	1	
4	760-062	Gasket	1	769-910
5	760-911	Rotor	1	
6	760-006	Ejection ring	2	
7	760-005	Rotor blade	4	769-910
8	760-008	Cover plate	1	
9	760-009	Gasket	1	769-910
10	808-052	Shaft seal	1	769-910
11	760-007	Seal housing	1	
12	808-031	O-ring	1	769-910
13	804-052	Circlip	1	769-910
14	806-024	Dowel pin	4	
15	807-028	Bearing	1	
16	807-025	Bearing	1	
18	811-020	Key	1	
19	760-023	Foot (VA6J only)	1	
21	809-009	Screw	12	
23	805-006	Screw	3	
24		Screw	3	
25	802-012	Screw (VA6J only)	4	
	769-910	V6 Seal Kit		

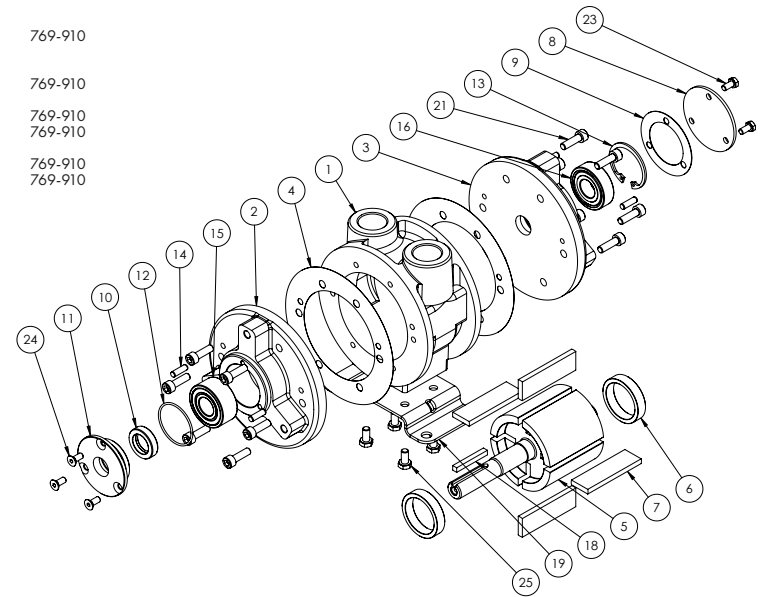

VS6C

Item	Part No.	Description	Qty	Kit No.
1	760-101	Body BSP	1	
2	760-036	Front plate	1	
3	760-002	Back plate	1	
4	760-062	Gasket	1	769-910
5	760-921	Rotor	1	
6	760-006	Ejection ring	2	
7	760-005	Rotor blade	4	769-910
8	760-008	Cover plate	1	
9	760-009	Gasket	1	769-910
10	808-057	Shaft seal	1	769-910
11	780-007	Seal housing	1	
12	808-030	O-ring	1	769-910
13	804-052	Circlip	1	769-910
14	806-024	Dowel pin	4	
15	807-026	Bearing	1	
16	807-025	Bearing	1	
18	811-001	Key	1	
21	809-007	Screw	6	
22	809-009	Screw	6	
23	805-006	Screw	3	
	769-910	V6 Seal Kit		

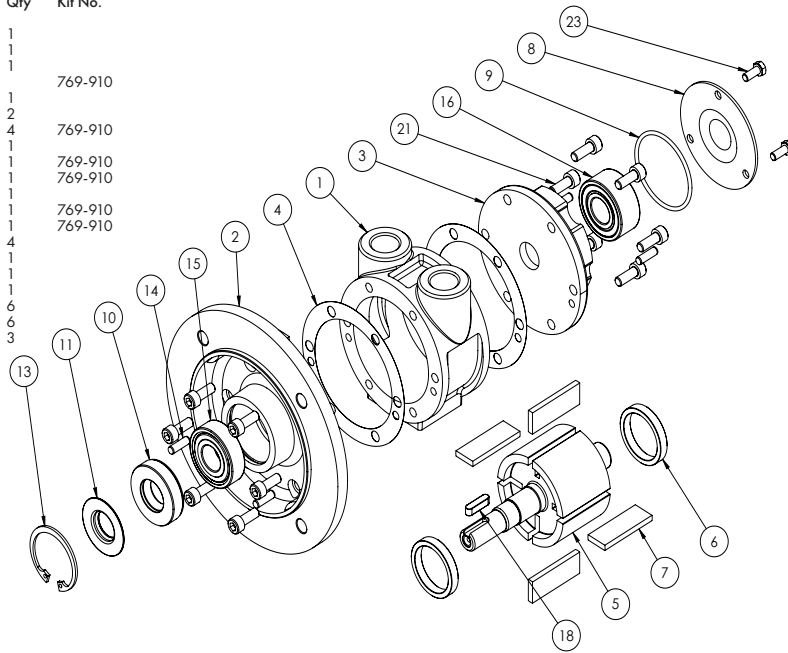

Note: With air inlet at port 'A', rotation is clockwise looking on shaft.

For opposite rotation, reverse ports.

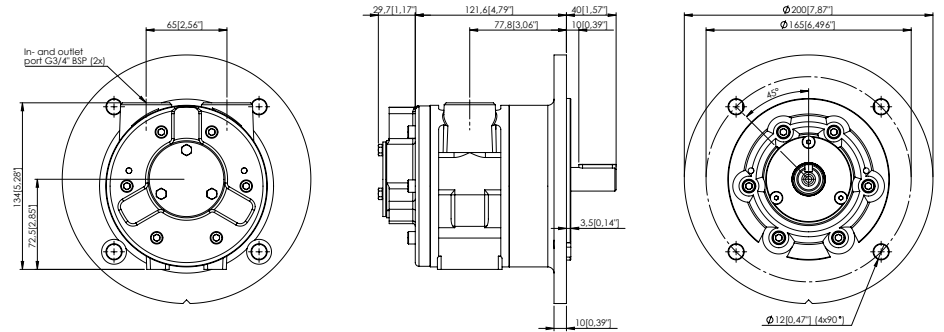

- Maximum temperature -20°C to +60°C (-4°F to +140°F)
- Silencer supplied with motor
- Max. Overhung Force on shaft 300 N (70 lbf.)
- Axial loads should be kept to a minimum
- Mass 10 kg

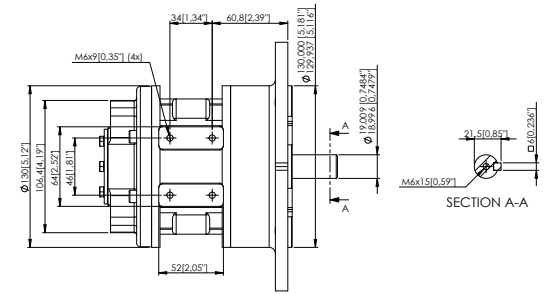

VA6C

Item	Part No.	Description	Qty	Kit No.
1	760-001	Body NPT	1	
2	760-018	Front plate	1	
3	760-002	Back plate	1	
4	760-062	Gasket	1	769-910
5	760-911	Rotor	1	
6	760-006	Ejection ring	2	
7	760-005	Rotor blade	4	769-910
8	760-008	Cover plate	1	
9	760-009	Gasket	1	769-910
10	808-052	Shaft seal	1	769-910
11	760-017	Seal housing	1	
12	808-031	O-ring	1	769-910
13	804-052	Circlip	1	769-910
14	806-024	Dowel pin	4	
15	807-025	Bearing	1	
16	807-028	Bearing	1	
18	811-020	Key	1	
21	809-007	Screw	6	
22	809-009	Screw	6	
23	805-006	Screw	3	
24		Screw	3	
	769-910	V6 Seal Kit		

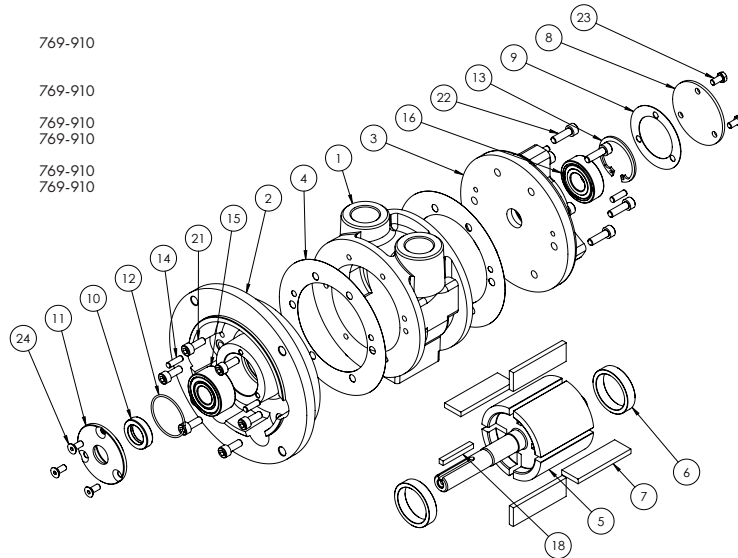

Note: With air inlet at port 'A', rotation is clockwise looking on shaft.

For opposite rotation, reverse ports.

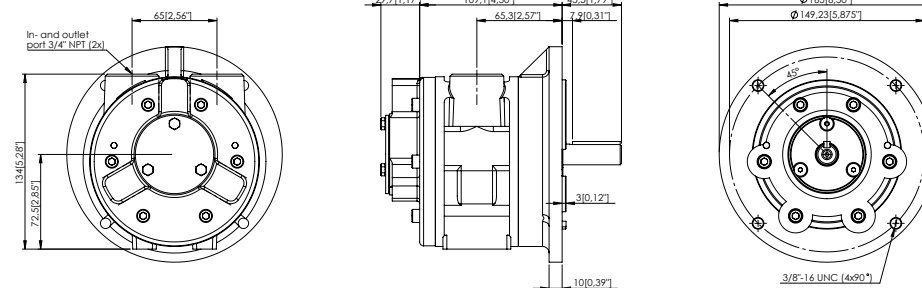

- Maximum temperature -20°C to +60°C (-4°F to +140°F)
- Silencer supplied with motor
- Max. Overhung Force on shaft 300 N (70 lbf.)
- Axial loads should be kept to a minimum
- Mass 10 kg

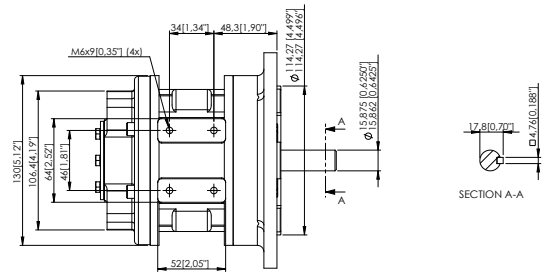

Accessories for the GLOBE Air Motor

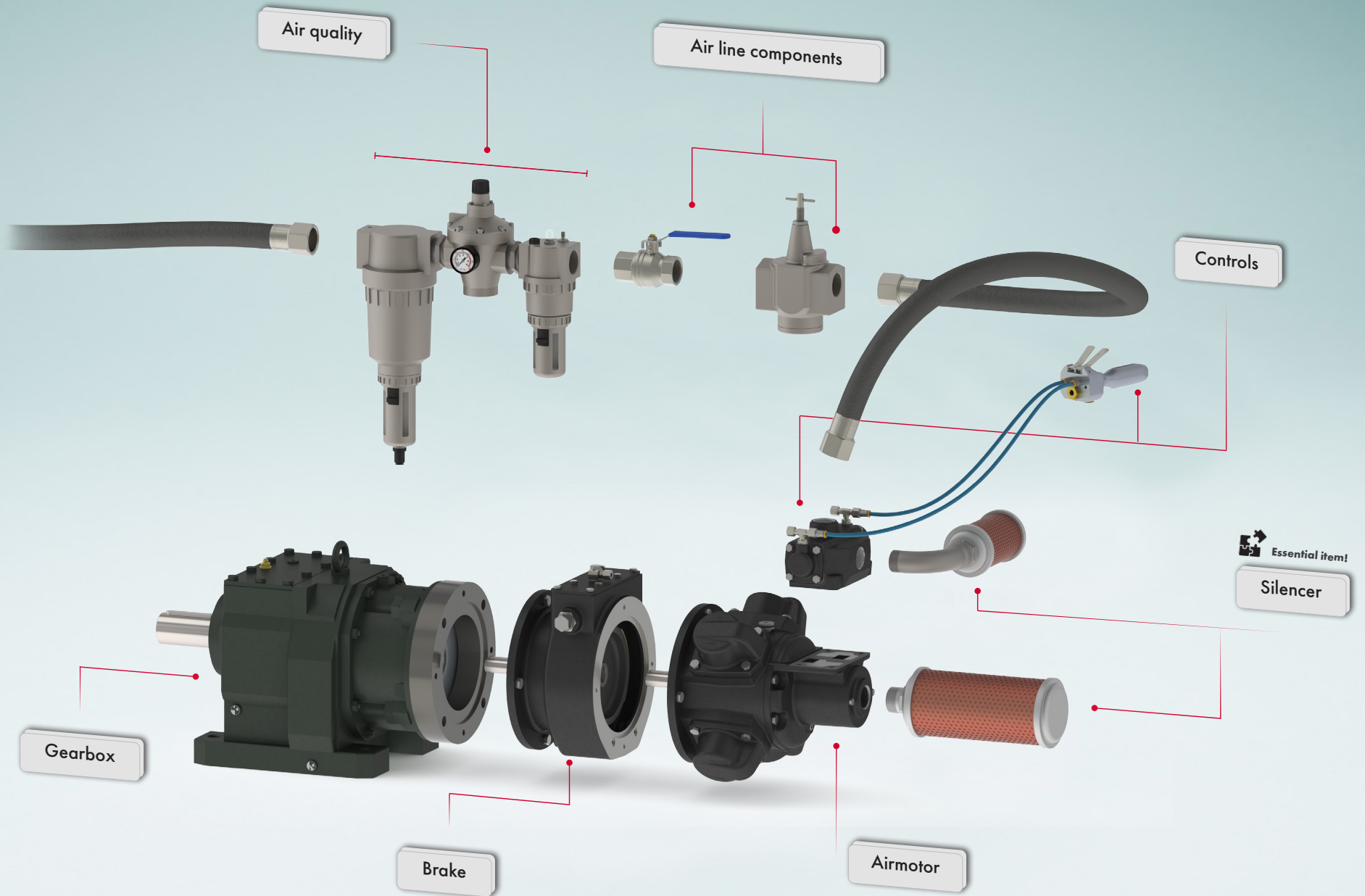

For specifications, see next page.

Accessories for the GLOBE V6 Vane Air Motor

Complete your V6 Vane Air Motor with many different accessories. Order your GLOBE air motor with the desired options, and have it delivered to you completely assembled. In addition, you are assured of GLOBE quality for your air motor and assembly.



For
VA6C VA6J VA6X VS6C

Many of our accessories, including the brakes, are ATEX certified. With the GLOBE air motors & accessories you can always work safely in explosion-prone areas. See below which options we offer for your air motor.

Controls

We offer many different control valves for our air motors. For example we supply proportional control valves which are mounted directly onto the air motor. They allow you to not only change the direction of the motor, but also the speed of the motor. Besides the proportional control valves we also offer standard control valves suitable for our air motors.

The following control valves are available for the GLOBE V6 Vane Air Motor:

Hand Controlled

ART. NR
223-900

Remote Controlled

ART. NR
221-900

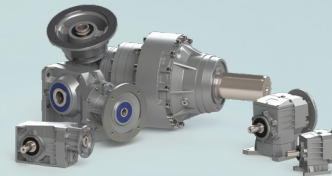

Gearbox

The GLOBE vane air motors are available with worm, coaxial and planetary gearboxes. The gearboxes are mounted directly onto the vane motors. This design makes them compact and well protected from external influences. The gearboxes are compatible with all our vane airmotors, available in stainless steel and with ATEX-Certification.

The following gearboxes are available for the GLOBE V6 Vane Air Motor:

Worm

Planetary

Coaxial

PFG

Brakes

The combination of motor with brake is widely used for winches, cranes and positioning devices. The ATEX approved brakes within the GLOBE program have a very compact built and are very robust. All brakes are built from cast iron or steel housings and are easy to install on our air motors and gearboxes.

BN90

Holding Torque	14 Nm / 13,3 lbs ft.
Release pressure	3,4 bar / 50 PSI
Flange type	71 B5
Mounting options	IEC, NEMA

ART. NR
A414BN90

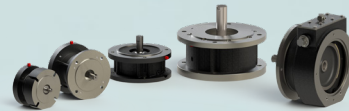

Service Kits

Regular maintenance is important to ensure a long service life of your vane air motor. Our service kits are specifically designed for your vane air motor. One servicekit contains everything you need for a service maintenance. We recommend to always have at least one service kit available in case of unexpected maintenance.

ART. NR
769-910



Air quality & Air line components

FRL systems combine a shut off valve, filter, regulator and a lubricator in a ready to use set. It provides you with clean air and an efficient system that will extend the service life of air-powered tools and equipment. By using a speed control valve, you can set your air motor to a desired RPM without reducing its torque. It allows large airflows to pass while minimizing pressure loss at the same time.

3/4" FRL Unit

Port size	3/4 inch
Max. operating pressure	10 bar / 145 PSI
Housing material	Aluminium
Weight	1.41 KG / 3.11 lb

Speed regulator

Port size	3/4 inch
Port thread	NPT / BSP

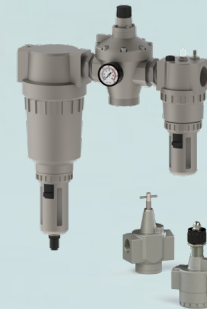

Essential item!

3/4" Silencer

An air motor may produce noise that can be harmful to surrounding workers and/or cause noise problems in the application. The GLOBE Pneumatic air silencers are a simple and cost-effective solution to reduce noise levels and unwanted discharge of contaminants.

A GLOBE Silencer is required for optimal reach of maximum power. Choosing a GLOBE Silencer over other brands can prevent loss of power or motor malfunctions. The GLOBE silencers are designed specifically for our motors.

ART. NR
A31820005

