



TANK SPECIALIST



brochure/catalogue

#tankspecialist

WETANKYOU SINCE 1937

OIL TANKS

| | | |
|---|----|-----------|
| p | 9 | 26/36 |
| p | 9 | 36/26 |
| p | 10 | 44/54 |
| p | 11 | 50/64 |
| p | 12 | 50/64 T20 |
| p | 13 | 63/70 |
| p | 14 | 70/63 |
| p | 15 | 70/70 |
| p | 16 | 70/70 R |
| p | 17 | 63/27 |

DIESEL TANKS

| | | |
|---|----|-------|
| p | 19 | 26/36 |
| p | 19 | 44/54 |
| p | 20 | 50/64 |
| p | 20 | 64/50 |
| p | 21 | 63/70 |
| p | 22 | 70/63 |
| p | 23 | 70/70 |

COMBINED TANKS

| | | |
|---|----|-------|
| p | 25 | 50/64 |
| p | 26 | 64/50 |
| p | 27 | 63/70 |
| p | 28 | 70/70 |

ACCESSORIES OIL TANKS

| | | |
|---|----|---|
| p | 30 | Semi-immersed Return Filters |
| p | 30 | Immersed Return Filters for Easy Kit |
| p | 30 | Immersed Easy Filters |
| p | 30 | Evo Filters |
| p | 31 | In-line filters |
| p | 31 | Filter's clogging visual indicator |
| p | 31 | Aluminium cover with return connection and pipe |
| p | 31 | Air breather caps |
| p | 32 | Level indicators |
| p | 32 | Adjustable ball valves |
| p | 32 | Pipe fittings |
| p | 32 | Adjustable fittings |

ACCESSORIES DIESEL TANKS

| | | |
|---|----|--|
| p | 34 | Diesel level indicators (for Padoan tanks) |
| p | 34 | Analogic cabin diesel oil indicator (to be installed with the generic level indicator and Padoan tanks) |
| p | 34 | Diesel connection kits |
| p | 35 | Fuel caps |
| p | 35 | VDO Cap |

TANK SPECIALIST

Family company since 1937, we are a prime manufacturer of oil, diesel and combined tanks for industrial vehicles and machinery.

Our strong focus on R&D, innovation, technology and support to our customers is translated into action by the Italian headquarters and subsidiary companies in Switzerland, Germany and Chile: PADOAN GROUP.

We develop our products working side by side with our customers who mainly are bodybuilders, OEMs and distribution networks in more than 50 Countries worldwide.

The Italian design and quality mark out our wide range of tanks that is divided in "N" (the standard and multipurpose line) and "X", tanks which are designed and customized according to the customer and application needs.

Do not hesitate to contact us to reach your goals.

Our mission and vision can be expressed by our payoff: **WETANKYOU since 1937.**

We want to be a partner more than a supplier, working by your side and reaching your goals.

That is the reason why every day we ThANK people and companies who trust us as a partner to develop their projects and strategies.

At the same time we ThANK our team of more than 200 people worldwide who, for more than 80 years, provides quality and value we share with you.

Go to the configurator



www.padoan.it/en/configurator/

Go to the virtual showroom



www.padoan.it/en/virtual-showroom/

Visit Padoan website



www.padoan.it

PRODUCTS CATALOGUE

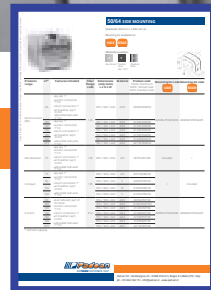

Download the technical sheet with details

The complete product code is composed by the material code and the product code listed in the table for each item.
(example: NSOA0070035MF00)

For dimensions with mounting kit, please refer to the technical sheet you can download by scanning the QR Code



44/54 (sidewalls 440 mm h x 540 mm w)

Mounting kit available for:



Materials available:



Download specifics www.padoan.it/documents/Padoan_OIL_44-54_EN.pdf

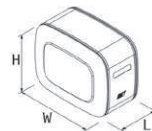

Code of filter flange that couples with Padoan filters

| Products range | LT* | Features included | Filter flange code | Dimensions (only tank) L x H x W | Material | Product code NSOA: Aluminium NSOF: Painted steel | Mounting kit code SIDE | Mounting kit code REAR |
|---------------------|-------|--|--------------------|----------------------------------|----------|--|----------------------------------|----------------------------------|
| Multi Function (MF) | 60-70 | - level gauge 127mm - suction connection 1"1/4 - return connection 1" - air breather cap h 41mm - adjustable ball valve 1" 1/4 | 135 | 350 x 440 x 540 | A/F | -0070035MF00 | SIDE | REAR |
| | 80 | - spy eye 1" - suction connection | | 400 x 440 x 540 | A/F | -0080040MF00 | | |

Code for the specific mounting kit

| OIL TANKS | LT / TANK SIDEWALL | 26/36 | 36/26 | 44/54 | 50/64 | 50/64 T20 | 63/70 | 70/63 | 70/70 | 70/70R | 63/27 |
|-----------|--------------------|-------|-------|-------|-------|-----------|-------|-------|-------|--------|-------|
| | 30 | p 9 | p 9 | | | | | | | | |
| | 40 | p 9 | p 9 | | | | | | | | |
| | 50 | p 9 | p 9 | | | | | | | | |
| | 60-70 | | | p 10 | | | | | | | |
| | 75 | | | | p 11 | p 12 | | | | | |
| | 80 | | | p 10 | | | | | | | |
| | 90 | | | p 10 | p 11 | | | | | p 16 | |
| | 100 | | | | p 11 | p 12 | | | | | |
| | 110 | | | | | | | | | | p 17 |
| | 120 | | | | p 11 | p 12 | p 13 | p 14 | | | |
| | 130 | | | | p 11 | | | | p 15 | | |
| | 135 | | | | | | p 13 | p 14 | | | p 17 |
| | 140 | | | | | p 12 | | | | | |
| | 150 | | | | p 11 | p 12 | p 13 | p 14 | p 15 | | |
| | 160 | | | | p 11 | | | | | | |
| | 170 | | | | | | p 13 | p 14 | p 15 | | |
| | 180 | | | | | | | | | p 16 | p 17 |
| | 200 | | | | | p 12 | p 13 | p 14 | p 15 | | p 17 |
| | 215 | | | | p 11 | | | | | | |
| | 250 | | | | | p 12 | p 13 | | p 15 | | |
| | 300 | | | | | p 12 | | | | | |
| | 400 | | | | | p 12 | | | | | |

| DIESEL TANKS | LT / TANK SIDEWALL | 26/36 | 44/54 | 50/64 | 64/50 | 63/70 | 70/63 | 70/70 |
|--------------|--------------------|-------|-------|-------|-------|-------|-------|-------|
| | 60 | p 19 | | | | | | |
| | 80 | p 19 | | | | | | |
| | 90 | | | p 20 | p 20 | | | |
| | 110 | | | | | p 21 | p 22 | |
| | 120 | p 19 | | | | | | |
| | 125 | | | | | | | p 23 |
| | 135 | | | | | p 21 | p 22 | |
| | 160 | | | | | | | p 23 |
| | 170 | | | | | | | p 23 |
| | 180 | | p 19 | | | | | |
| | 200 | | | | | p 21 | p 22 | p 23 |
| | 210 | | p 19 | | | | | |
| | 215 | | | | | | | p 23 |
| | 240 | | | | | p 21 | p 22 | |
| | 250 | | p 19 | | | | | |
| | 260 | | | | | | | p 23 |
| | 280 | | | p 20 | p 20 | | | |
| | 290 | | | | | p 21 | p 22 | |
| | 300 | | p 19 | | | | | |
| | 310 | | | | | | | p 23 |
| | 350 | | | p 20 | p 20 | | | p 23 |

continue →

| DIESEL TANKS | LT / TANK SIDEWALL | 26/36 | 44/54 | 50/64 | 64/50 | 63/70 | 70/63 | 70/70 |
|---------------------|---------------------------|--------------|--------------|--------------|--------------|--------------|--------------|--------------|
| | 360 | | | | | p 21 | p 22 | |
| | 400 | | | | | p 21 | p 22 | p 23 |
| | 425 | | | p 20 | p 20 | | | |
| | 445 | | | | | | | p 23 |
| | 450 | | | p 20 | p 20 | p 21 | p 22 | |
| | 500 | | | | | p 21 | p 22 | p 23 |
| | 520 | | | p 20 | p 20 | | | |
| | 540 | | | | | | | p 23 |
| | 550 | | | | | p 21 | p 22 | |
| | 570 | | | p 20 | p 20 | | | |
| | 590 | | | | | | | p 23 |
| | 600 | | | | | p 21 | p 22 | |
| | 650 | | | | | p 21 | p 22 | |
| | 670 | | | | | p 21 | p 22 | |
| | 680 | | | | | | | p 23 |
| | 730 | | | | | p 21 | p 22 | |
| | 815 | | | | | p 21 | p 22 | p 23 |
| | 910 | | | | | | | p 23 |
| | 960 | | | | | | | p 23 |

| COMBINED TANKS | LT (DIESEL/OIL) / TANK SIDEWALL | 50/64 | 64/50 | 63/70 | 70/70 |
|-----------------------|--|--------------|--------------|--------------|--------------|
| | 125/140 | | | p 27 | |
| | 140/170 | | | p 27 | |
| | 150/150 | | | | p 28 |
| | 160/120 | p 25 | p 26 | | |
| | 160/150 | | | p 27 | |
| | 175/105 | p 25 | p 26 | | |
| | 180/170 | | | p 27 | |
| | 190/200 | | | p 27 | |
| | 190/90 | p 25 | p 26 | | |
| | 200/150 | | | p 27 | p 28 |
| | 200/200 | | | | p 28 |
| | 220/170 | | | p 27 | p 28 |
| | 280/170 | | | | p 28 |
| | 280/200 | | | p 27 | |
| | 300/200 | | | | p 28 |
| | 340/200 | | | | p 28 |
| | 380/200 | | | p 27 | |
| | 400/200 | | | | p 28 |
| | 410/170 | | | p 27 | |
| | 480/200 | | | | p 28 |
| | 600/200 | | | p 27 | p 28 |
| | 700/200 | | | | p 28 |

TANK SPECIALIST

FOR INDUSTRIAL/
COMMERCIAL VEHICLES
AND MACHINERY

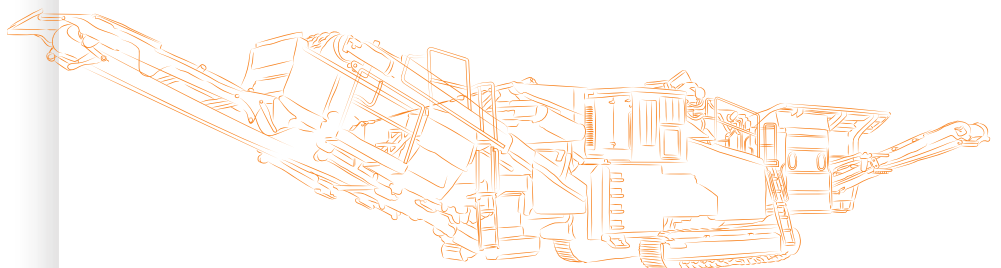
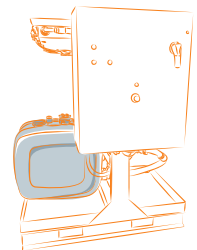
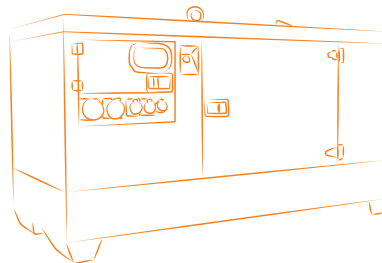
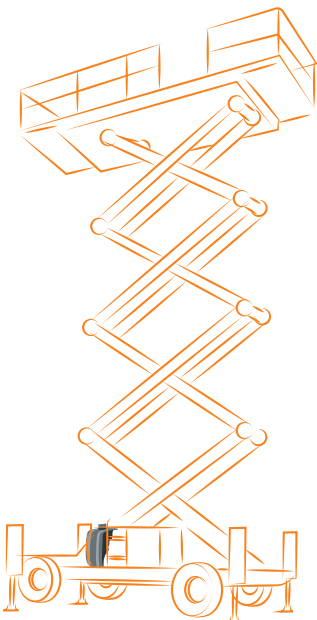
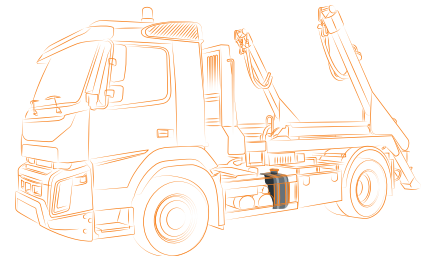
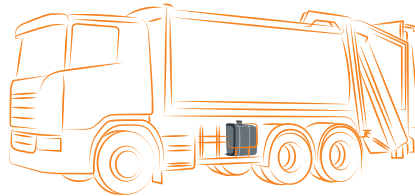
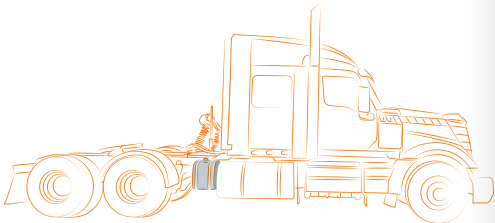
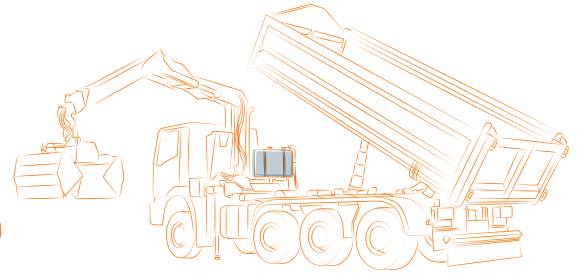
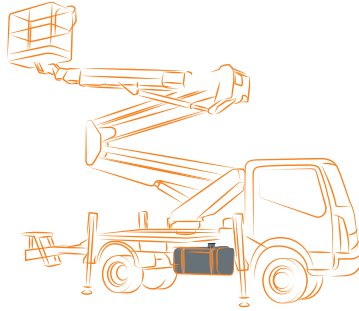
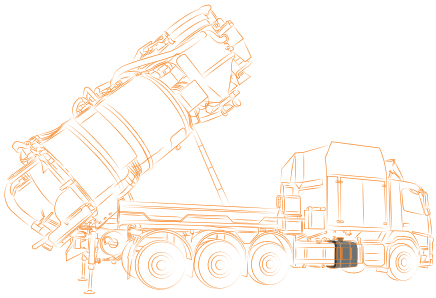
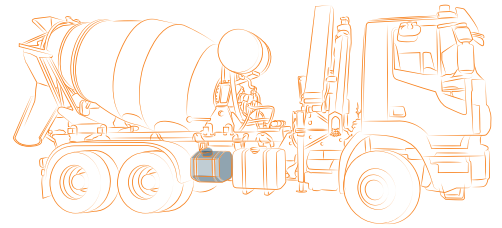
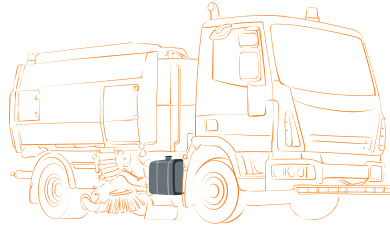
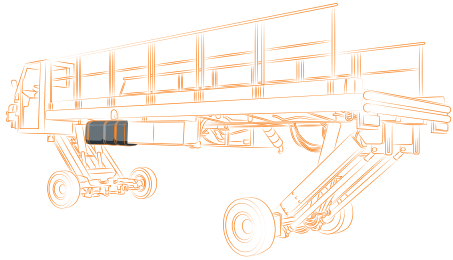
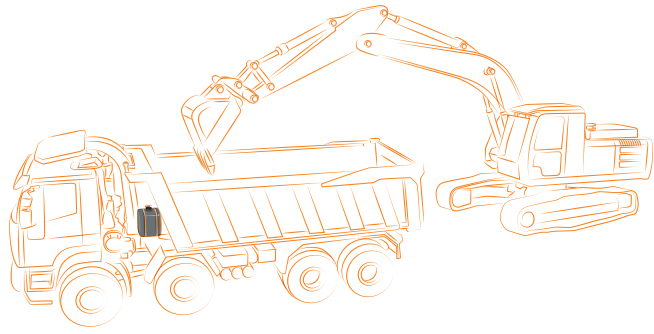



RAW MATERIAL USED IN AUTOMOTIVE FIELD

The material we use guarantees resistance, finishing, longer life expectancy, high quality perception to create premium products.



AUTOMATIZED WELDING PROCESS

For several years our welding process has been carried out by automatized robots, through the adoption of the MIG/MAG technology.

This allows a better internal cleaning avoiding the contamination normally caused by manual or standard welding.



PAINTING PROCESS

The painted steel tanks are finished with an epoxy powder coating (from 70 to 180 μ) to guarantee the protection from aggressive agents.

Moreover, on request, primer is also applied for a further protection.



RELIABILITY TEST WITH CRACK TESTING MACHINE

All of our tanks components, including brackets and straps, are tested with our cracking vibration machine to verify the life expectancy and quality of our products.



PRODUCT IDENTIFICATION WITH DISTINCTIVELY LABEL

Each tank is identified through a serial number. This individual "identity card" allows the traceability through the whole production chain and simplifies the communication between the customer and the supplier, for any needs.



INTERNAL CLEANING

On request, an innovative work station is available for the internal flushing of our aluminium and stainless steel tanks.

This process is optional and represents an opportunity for companies who certify their equipment as, after this process, a declaration of conformity to the ISO16232 cleaning standards is issued by Padoan.

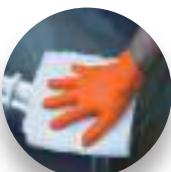

EXTERNAL CLEANING

We take care of the finishing of each tank. To emphasize the quality of processes and materials a manual cleaning is carried out by our team.



INSTRUCTION FOR ANY INSTALLATION KIT

All tanks and kits are supplied with instructions, to give the installers all the necessary key-points to save time and ease the assembly process.

Instructions are available in four languages.



PROTECTIVE SHELLS AND HIGH RESISTANCE CARDBOARD

No additional costs for the high quality protection guaranteed by shells tailored for each type of sidewall sizing and by the high resistance cardboard.

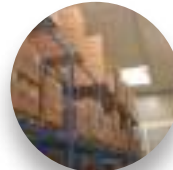

PROMPT DELIVERY

Quality and efficiency are part of our vision, managed also with a wide range of tanks and accessories to ensure a prompt delivery to our clients.

More than 3.500 tanks, in fact, are always on stock with a constant turnover.



MULTIFITTINGS SIDE INSTALLATION KIT

Our brackets are designed with a multipurpose fixing holes solution that grants a wide range of mounting combination on different chassis.

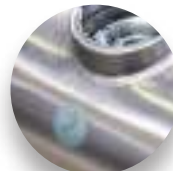

QUALITY TEST 1:1 WITH LEAK DETECTOR

Every tank is tested through an automatized machinery to verify any microscopic loss, using helium technology.

Every tank is marked with a label to indicate it has been tested and approved.



EPDM PROTECTION

The particular design allows to protect hands and materials from the cutting edge. The EPDM is installed on straps and brackets.

This specific material, compared to PVC, maintains its features in a wider range of temperature (-45°, +150°).



STAINLESS STEEL STRAPS AND CRADLE MOUNTING KIT

The correct positioning of the tanks is fundamental to guarantee a lasting application. This is the reason why we only use stainless steel straps which are resistant to the weather conditions and to rusting, and cradle mounting kits which fasten the tank by reining it in and avoid damages due to vibrations.

oil tanks



26/36 (sidewalls 260 mm h x 360 mm w)

Mounting kit available:

SIDE

Materials available:

A

Aluminium

F

Painted Steel
RAL 7021



Download specifics
www.padoan.it/documents/Padoan_OIL_26-36_EN.pdf

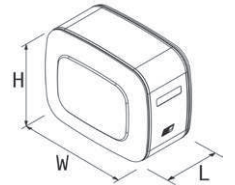

| Products range | LT* | Features included | Filter Flange Code | Dimensions (only tank) L x H x W | Material | Product code NSOA: Aluminium NSOF: Painted steel | Mounting kit code SIDE | Mounting kit code REAR |
|---------------------|-----|--|--------------------|----------------------------------|----------|--|----------------------------------|----------------------------------|
| Multi Function (MF) | 40 | - spy eye 3/4" - suction connection 1"1/4 | 135 | 465 x 260 x 360 | A | -0040046H000 | AKMISLT263640N0 | / |
| | 50 | | | 565 x 260 x 360 | A | -0050056H000 | | |
| Multi Function (MF) | 30 | - air breather cap h 41mm | 135 | 365 x 260 x 360 | F | -0030036H000 | welded mounting kit included | / |
| | 40 | | | 465 x 260 x 360 | F | -0040046H000 | | |
| | 50 | | | 565 x 260 x 360 | F | -0050056H000 | | |

* Full tank capacity

Accessories pp 30-32

36/26 (sidewalls 360 mm h x 260 mm w)

Mounting kit available:

REAR

Material available:

F

Painted Steel
RAL 7021



Download specifics
www.padoan.it/documents/Padoan_OIL_36-26_EN.pdf

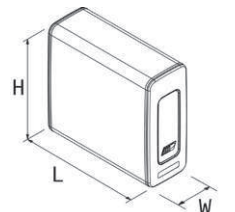

| Products range | LT* | Features included | Filter Flange Code | Dimensions (only tank) L x H x W | Material | Product Code NSOF: Painted steel | Mounting kit code SIDE | Mounting kit code REAR |
|---------------------|-----|--|--------------------|----------------------------------|----------|-------------------------------------|----------------------------------|----------------------------------|
| Multi Function (MF) | 30 | - spy eye 3/4" - suction connection 1"1/4 | 135 | 365 x 360 x 260 | F | -0030036V000 | / | welded mounting kit included |
| | 40 | - air breather cap h 41mm | | 465 x 360 x 260 | F | -0040046V000 | | |
| | 50 | - adjustable ball valve 1" 1/4 | | 565 x 360 x 260 | F | -0050056V000 | | |

* Full tank capacity

Accessories pp 30-32

oil tanks

44/54 (sidewalls 440 mm h x 540 mm w)

Download specifics

www.padoan.it/documents/Padoan_OIL_44-54_EN.pdf

Mounting kit available for:

SIDE **REAR**

Materials available:

A **F**

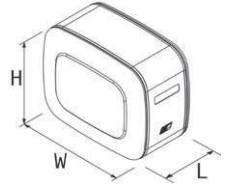
 Aluminium Painted
 Steel
 RAL 7021

| Products range | LT* | Features included | Filter flange code | Dimensions (only tank) L x H x W | Material | Product code NSOA: Aluminium NSOF: Painted steel | Mounting kit code | |
|---------------------|-------|--|--------------------|-------------------------------------|----------|--|-------------------|-----------------|
| | | | | | | | SIDE | REAR |
| Multi Function (MF) | 60-70 | <ul style="list-style-type: none"> - level gauge 127mm - suction connection 1"1/4 - return connection 1" - air breather cap h 41mm - adjustable ball valve 1" 1/4 | 135 | 350 x 440 x 540 | A/F | -0070035MF00 | AKMISLT44544000 | AKMISRC04405404 |
| | 80 | <ul style="list-style-type: none"> - spy eye 1" - suction connection 1"1/4 - return connection 1" | | 400 x 440 x 540 | A/F | -0080040MF00 | | |
| | 90 | <ul style="list-style-type: none"> - air breather cap h 41mm - adjustable ball valve 1" 1/4 | | 450 x 440 x 540 | A/F | -0090045MF00 | | |

* Full tank capacity

Accessories pp 30-32

50/64 (sidewalls 500 mm h x 640 mm w)



Mounting kit available for:





Materials available:

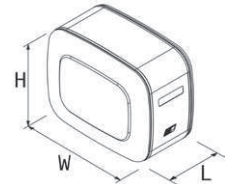

Download specifics
www.padoan.it/documents/Padoan_OIL_50-64_EN.pdf



| Products range | LT* | Features included | Filter flange code | Dimensions (only tank) L x H x W | Material | Product code NSOA: Aluminium NSOF: Painted steel NSOI: Stainless steel | Mounting kit code  | Mounting kit code  |
|---------------------|-----|---|--------------------|-------------------------------------|----------|---|--|--|
| Multi Function (MF) | 90 | - spy eye 1" - suction connection 1"1/4 - return connection 1" - air breather cap h 41mm adjustable ball valve 1" 1/4 | 135 | 350 x 500 x 640 | A/F/I | -0090035MF00 | AKMISLT50645000 | AKMISRC05006405 |
| | 100 | - spy eye 1" | | 400 x 500 x 640 | A/F/I | -0100040MF00 | | |
| | 120 | - suction connection 1"1/2 | | 450 x 500 x 640 | A/F/I | -0120045MF00 | | |
| | 130 | - return connection 1" | | 500 x 500 x 640 | A/F/I | -0130050MF00 | | |
| | 150 | - air breather cap h 41mm | | 550 x 500 x 640 | A/F/I | -0150055MF00 | | |
| | 160 | - adjustable ball valve 1" 1/2 | | 600 x 500 x 640 | A/F/I | -0160060MF00 | | |
| | 215 | | | 780 x 500 x 640 | A/F/I | -0215078MF00 | | |
| Monobacket | 75 | - spy eye 1" - suction connection 1"1/4 - return connection 1" - air breather cap h 41mm - adjustable ball valve 1" 1/4 | 135 | 300 x 500 x 640 | A/F | -0075030CF00 | included | / |
| Compact | 75 | - spy eye 1" - suction connection 1"1/4 | 135 | 300 x 500 x 640 | A/F | -0075030RC00 | / | included |
| | 90 | - return connection 1" | | 350 x 500 x 640 | F | -0090035RC00 | | |
| | 100 | - air breather cap h 41mm | | 400 x 500 x 640 | F/I | -0100040RC00 | | |
| | 120 | - adjustable ball valve 1" 1/4 | | 450 x 500 x 640 | F | -0120045RC00 | | |
| Evo (ET) | 90 | | Evo | 350 x 500 x 640 | A/F/I | -0090035ET00 | AKMISLT50645000 | AKMISRC05006405 |
| | 100 | - level indicator part of Evo Filter | | 400 x 500 x 640 | A/F/I | -0100040ET00 | | |
| | 120 | - suction connection 1"1/4 | | 450 x 500 x 640 | A/F/I | -0120045ET00 | | |
| | 130 | - return connection 1" | | 500 x 500 x 640 | A/F/I | -0130050ET00 | | |
| | 150 | - adjustable ball valve 1" 1/4 | | 550 x 500 x 640 | A/F/I | -0150055ET00 | | |
| | 160 | | | 600 x 500 x 640 | A/F/I | -0160060ET00 | | |
| | 215 | | | 780 x 500 x 640 | A/F/I | -0215078ET00 | | |

* Full tank capacity

50/64 T20 (sidewalls 500 mm h x 640 mm w)



Mounting kit available:

SIDE

Materials available:



Download specifics
www.padoan.it/documents/Padoan_OIL_50-64_T20_EN.pdf

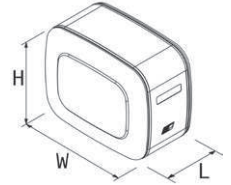

| Products range | LT* | Features included | Filter flange code | Dimensions (only tank) L x H x W | Material | Product code NSOA: Aluminium NSOF: Painted steel NSOI: Stainless steel | Mounting kit code SIDE | Mounting kit code REAR | |
|----------------|-----|---|--------------------|--|------------------|---|----------------------------------|----------------------------------|--------------|
| T20 | 75 | - air breather cap h 41mm - suction connection 1" 1/2 To define according to customers requirements: - level gauge - return connection - adjustable ball valve | 135 | 300 x 500 x 640 | A/F | -0075030T200 | AKMIMS0T25640N0 | | |
| | 100 | To define according to customers requirements: - level gauge - return connection - adjustable ball valve | 195 | 400 x 500 x 640 | A/F/I | -0100040T200 | AKMISLTT2564000 | / | |
| | 120 | | | - air breather cap h 41mm - suction connection 2" | 470 x 500 x 640 | A/F/I | | | -0120047T200 |
| | 140 | | | 530 x 500 x 640 | A/F/I | -0140053T200 | | | |
| | 150 | | | 570 x 500 x 640 | A/F/I | -0150057T200 | | | |
| | 200 | | | 750 x 500 x 640 | A/F/I | -0200075T200 | | | |
| | 250 | | | 930 x 500 x 640 | A/F/I | -0250093T200 | | | |
| | 300 | | | - air breather cap h 41mm - suction connection 2" 1/2 | 1100 x 500 x 640 | A/F/I | | | -0300110T200 |
| | 400 | To define according to customers requirements: - level gauge - return connection - adjustable ball valve | 1500 x 500 x 640 | A/F/I | -0400150T200 | | | | |

* Full tank capacity

63/70 (sidewalls 636 mm h x 706 mm w)







Download specifics
www.padoan.it/documents/Padoan_OIL_63-70_EN.pdf

Mounting kit available:

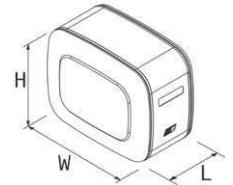
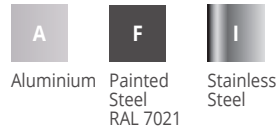

Materials available:



| Products range | LT* | Features included | Filter flange code | Dimensions (only tank) L x H x W | Material | Product code NSOA: Aluminium NSOF: Painted steel NSOI: Stainless steel | Mounting kit code  | Mounting kit code  |
|---------------------|-----|--|--------------------|----------------------------------|-----------------|---|--|--|
| Multi Function (MF) | 135 | - spy eye 1" | 135 | 350 x 636 x 706 | A/F/I | -0135035MF00 |  |  |
| | 150 | - suction connection 1" 1/2 | | 400 x 636 x 706 | A/F/I | -0150040MF00 | | |
| | 170 | - 2 x return connection 1" 1/4 - return connection 1" 1/4 | | 450 x 636 x 706 | A/F/I | -0170045MF00 | | |
| | 200 | - air breather cap h 41mm - adjustable ball valve 1" 1/2 | | 500 x 636 x 706 | A/F/I | -0200050MF00 | | |
| | 250 | - spy eye 1" - suction connection 2" - 2 x return connection 1" 1/4 - air breather cap h 41mm - adjustable ball valve 2" | 195 | 600 x 636 x 706 | A/F/I | -0250060CF00 | | |
| Monobacket | 120 | - spy eye 1" - suction connection 1"1/2 - return connection 1" | 135 | 300 x 636 x 706 | A/F/I | -0120030CF00 | included | / |
| | 135 | - air breather cap h 41mm - adjustable ball valve 1" 1/2 | | 350 x 636 x 706 | A/F/I | -0135035MFMS | | |
| Valve Plate (MFPG) | 135 | - spy eye 1" | 135 | 350 x 636 x 706 | A/F/I | -0135035MFPG |  |  |
| | 150 | - suction connection 1"1/2 | | 400 x 636 x 706 | A/F/I | -0150040MFPG | | |
| | 170 | - 2 x return connection 1" 1/4 - return connection 1" 1/4 | | 450 x 636 x 706 | A/F/I | -0170045MFPG | | |
| | 200 | - air breather cap h 41mm - adjustable ball valve 1" 1/2 | | 500 x 636 x 706 | A/F/I | -0200050MFPG | | |
| | 250 | - spy eye 1" - suction connection 2" - 2 x return connection 1" 1/4 - air breather cap h 41mm - adjustable ball valve 2" | | 195 | 600 x 636 x 706 | A/F/I | | |
| Compact | 135 | - spy eye 1" - suction connection 1" 1/4 - return connection 1" - air breather cap h 41mm - adjustable ball valve 1" 1/4 | 135 | 350 x 636 x 706 | A/F/I | -0135035RC00 | / | AKMISRC06307005 |
| Evo (ET) | 135 | - level indicator part of Evo Filter | Evo | 350 x 636 x 706 | A/F/I | -0135035ET00 |  |  |
| | 150 | - suction connection 1"1/2 | | 400 x 636 x 706 | A/F/I | -0150040ET00 | | |
| | 170 | - return connection 1" 1/4 | | 450 x 636 x 706 | A/F/I | -0170045ET00 | | |
| | 200 | - adjustable ball valve 1" 1/2 | | 500 x 636 x 706 | A/F | -0200050ET00 | | |

* Full tank capacity

oil tanks

70/63

 (sidewalls 706 mm h x 636 mm w)

Download specifics

www.padoan.it/documents/Padoan_OIL_70-63_EN.pdf

Mounting kit available:

SIDE **REAR**

Materials available:

| | | |
|-----------|---------------------------|-----------------|
| A | F | I |
| Aluminium | Painted Steel RAL 7021 | Stainless Steel |

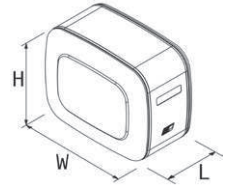

| Products range | LT* | Features included | Filter flange code | Dimensions (only tank) L x H x W | Material | Product code NSOA: Aluminium NSOF: Painted steel NSOI: Stainless steel | Mounting kit code SIDE | Mounting kit code REAR |
|---------------------|-----|--|--------------------|-------------------------------------|----------|---|----------------------------------|----------------------------------|
| Multi Function (MF) | 135 | - spy eye 1" - suction connection 1" 1/2 | 135 | 350 x 706 x 636 | F/I | -0135035C0RV | AKMISLT07006305 | AKMISRC07006305 |
| | 150 | - 2 x return connection 1" - return connection 1" 1/4 | | 400 x 706 x 636 | A/F/I | -0150040C0RV | | |
| | 170 | - air breather cap h 41mm | | 450 x 706 x 636 | A/F/I | -0170045C0RV | | |
| | 200 | - adjustable ball valve 1" 1/2 | | 500 x 706 x 636 | A/F/I | -0200050C0RV | | |
| Monobacket | 120 | - spy eye 1" - suction connection 1" 1/2 - return connection 1" - air breather cap h 41mm - adjustable ball valve 1" 1/2 | / | 300 x 706 x 636 | A/F | -0120030C0RV | included | / |

* Full tank capacity



70/70 (sidewalls 700 mm h x 700 mm w)

Mounting kit available:







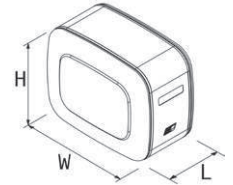

Materials available:



Download specifics
www.padoan.it/documents/Padoan_OIL_70-70_EN.pdf



| Products range | LT* | Features included | Filter flange code | Dimensions (only tank) L x H x W | Material | Product code NSOA: Aluminium NSOF: Painted steel | Mounting kit code | Mounting kit code |
|---------------------|-----|--|--------------------|----------------------------------|----------|--|---|---|
| | | | | | | |  |  |
| Multi Function (MF) | 150 | - spy eye 1" - suction connection 1" 1/2 | 135 | 350 x 700 x 700 | A/F | -0150035MF00 |  |  |
| | 170 | - 2 x return connection 1" - return connection 1" 1/4 - air breather cap h 41mm | | 400 x 700 x 700 | A/F | -0170040MF00 | | |
| | 200 | - adjustable ball valve 1" 1/2 | | 450 x 700 x 700 | A/F | -0200045MF00 | | |
| | 250 | - spy eye 1" - suction connection 2" - 2 x return connection 1" - air breather cap h 41mm - adjustable ball valve 2" | | 550 x 700 x 700 | A/F | -0250055CF00 | | |
| Monobacket | 130 | - spy eye 1" - suction connection 1" 1/2 - return connection 1" - air breather cap h 41mm - adjustable ball valve 1" 1/2 | 135 | 300 x 700 x 700 | A/F | -0130030CF00 | included | / |
| Evo (ET) | 170 | - spy eye 1" - suction connection 1" 1/2 | Evo | 400 x 700 x 700 | A | -0170040ET00 |  |  |
| | 200 | - return connection 1" - adjustable ball valve 1" 1/2 | | 450 x 700 x 700 | A | -0200045ET00 | | |

* Full tank capacity



70/70 R (sidewalls 700 mm h x 700 mm w)

Mounting kit available:



Material available:



Aluminium



Download specifics
www.padoan.it/documents/Padoan_OIL_70-70_EN_rearcabin.pdf

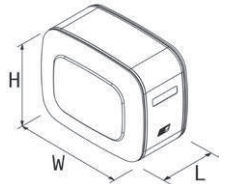

| Products range | LT* | Features included | Filter flange code | Dimensions (only tank) L x H x W | Material | Product code NKOA: Aluminium | Mounting kit code SIDE | Mounting kit code REAR |
|----------------|-----|--|--------------------|-------------------------------------|----------|---------------------------------|----------------------------------|----------------------------------|
| 70/70R | 90 | Master: - spy eye 1" - suction connection 1" 1/2 - return connection 1" - air connection 1/2" - air breather cap h 41mm | | 230 x 700 x 700 | | - 0090023RC01 | | |
| | 180 | Master: - spy eye 1" - suction connection 1" 1/2 - return connection 1" - air connection 1/2" - air breather cap h 41mm Slave: - suction connection 1" 1/2 - return connection 1" - air connection 1/2" | / | 230 x 700 x 700 | A | - 0180023RC01 | / | included |

* Full tank capacity



63/27 (sidewalls 638 mm h x 270 mm w)

Mounting kit available:

REAR

Materials available:



Aluminium



Painted Steel
RAL 7021



Stainless Steel



Download specifics

www.padoan.it/documents/Padoan_OIL_63-27_EN.pdf

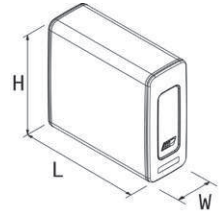

| Products range | LT* | Features included | Filter flange code | Dimensions (only tank) L x H x W | Material | Product code NSOA: Aluminium NSOF: Painted steel NSOI: Stainless steel | Mounting kit code SIDE | Mounting kit code REAR |
|------------------------|-----|--|--------------------|-------------------------------------|----------|---|----------------------------------|----------------------------------|
| Classic (RC) | 110 | - spy eye 1" - suction connection 1" 1/4 | 135 | 700 x 638 x 270 | A/F/I | -0110070RC00 | SIDE | REAR |
| | 135 | - air breather cap h 69mm - adjustable ball valve 1" 1/4 | | 860 x 638 x 270 | A/F/I | -0135086RC00 | | |
| | 180 | - spy eye 1" - suction connection 1" 1/2 | | 1150 x 638 x 270 | A/F/I | -0180115RC00 | | |
| | 200 | - air breather cap h 69mm - adjustable ball valve 1" 1/2 | | 1260 x 638 x 270 | A/F/I | -0200126RC00 | | |
| 2 Filter Flange (RC30) | 200 | - spy eye 1" - suction connection 1" 1/2 - return connection 1" - air breather cap h 69mm - adjustable ball valve 1" 1/2 | 2 x 135 | 1260 x 638 x 270 | A/F/I | -0200126RC30 | / | included |
| Evo (ET) | 110 | - spy eye 1" - suction connection 1" 1/4 | Evo | 700 x 638 x 270 | A/F/I | -0110070RE00 | SIDE | REAR |
| | 135 | - adjustable ball valve 1" 1/4 | | 860 x 638 x 270 | A/F/I | -0135086RE00 | | |
| | 180 | - spy eye 1" - suction connection 1" 1/2 | | 1150 x 638 x 270 | A/F/I | -0180115RE00 | | |
| | 200 | - adjustable ball valve 1" 1/2 | | 1260 x 638 x 270 | A/F | -0200126RE00 | | |

* Full tank capacity

Accessories pp 30-32

diesel tanks





26/36 (sidewalls 260 mm h x 360 mm w)

Mounting kit available:

SIDE

Materials available:

A Aluminium
F Painted Steel RAL 7021



Download specifics
www.padoan.it/documents/Padoan_DIESEL_26-36_EN.pdf

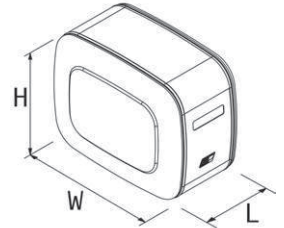

| Products range | LT* | Features included | Dimensions (only tank) L x H x W | Material | Product code NSGA: Aluminium NSGF: Painted steel | Mounting kit code SIDE |
|----------------|-----|--|----------------------------------|----------|--|----------------------------------|
| 26/36 diesel | 60 | - fuel cap with key and breathing valve | 675 x 260 x 360 | A/F | - 0060067C100 | Included |
| | 80 | - bayonet connection (for VDO level indicator) | 895 x 260 x 360 | | - 0080090C100 | |
| | 120 | - diesel drainage - homologation ECE34 Part III (side installation) | 1315 x 260 x 360 | | - 0120132C100 | |

* Full tank capacity

Accessories pp 34-35



44/54 (sidewalls 440 mm h x 540 mm w)

Mounting kit available:

SIDE

Materials available:

A Aluminium
F Painted Steel RAL 7021



Download specifics
www.padoan.it/documents/Padoan_DIESEL_44-54_EN.pdf

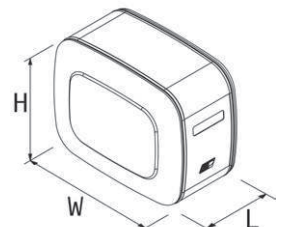

| Products range | LT* | Features included | Dimensions (only tank) L x H x W | Material | Product code NSGA: Aluminium NSGF: Painted steel | Mounting kit code SIDE |
|----------------|-----|---|----------------------------------|----------|--|----------------------------------|
| 44/54 diesel | 180 | - fuel cap with key and breathing valve | 850 x 440 x 540 | A/F | - 0180085C100 | Included |
| | 210 | - bayonet connection (for VDO level indicator) | 1000 x 440 x 540 | | - 0210100C100 | |
| | 250 | - diesel drainage | 1200 x 440 x 540 | | - 0250120C100 | |
| | 300 | - homologation ECE34 Part III (side installation) | 1400 x 440 x 540 | | - 0300140C100 | |

* Full tank capacity

Accessories pp 34-35

diesel tanks

50/64 (sidewalls 500 mm h x 640 mm w)

Mounting kit available:

SIDE

Materials available:



Aluminium



Painted Steel
RAL 7021



Stainless Steel



Download specifics

www.padoan.it/documents/Padoan_DIESEL_50-64_EN.pdf

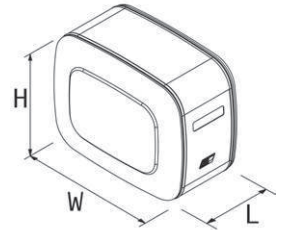

| Products range | LT* | Features included | Dimensions (only tank) L x H x W | Material | Product code NSGA: Aluminium NSGF: Painted steel NSGI: Stainless steel | Mounting kit code SIDE |
|----------------|-----|---|-------------------------------------|----------|---|----------------------------------|
| 50/64 diesel | 90 | <ul style="list-style-type: none"> - fuel cap with key and breathing valve - bayonet connection (for VDO level indicator) - diesel drainage - homologation ECE34 Part III (side installation) | 350 x 500 x 640 | A/F/I | - 0090035C100 | Included |
| | 280 | | 1000 x 500 x 640 | | - 0300100C100 | |
| | 350 | | 1250 x 500 x 640 | | - 0380125C100 | |
| | 425 | | 1500 x 500 x 640 | | - 0400150C100 | |
| | 450 | | 1600 x 500 x 640 | | - 0500160C100 | |
| | 520 | | 1800 x 500 x 640 | | - 0550180C100 | |
| | 570 | | 2000 x 500 x 640 | | - 0600200C100 | |

* Full tank capacity

Accessories pp 34-35

64/50 (sidewalls 640 mm h x 500 mm w)**

Mounting kit available:

SIDE

Materials available:



Aluminium



Painted Steel
RAL 7021



Stainless Steel



Download specifics

www.padoan.it/documents/Padoan_DIESEL_64-50_EN.pdf

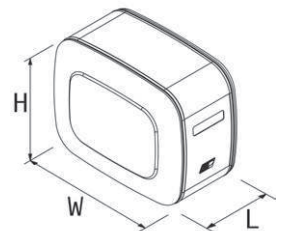

| Products range | LT* | Features included | Dimensions (only tank) L x H x W | Material | Product code NSGA: Aluminium NSGF: Painted steel NSGI: Stainless steel | Mounting kit code SIDE |
|----------------|-----|---|-------------------------------------|----------|---|----------------------------------|
| 64/50 diesel | 90 | <ul style="list-style-type: none"> - fuel cap with key and breathing valve - bayonet connection (for VDO level indicator) - diesel drainage - homologation ECE34 Part III (side installation) | 350 x 640 x 500 | A/F/I | - 0090035C1RV | Included |
| | 280 | | 1000 x 640 x 500 | | - 0280100C1RV | |
| | 350 | | 1250 x 640 x 500 | | - 0350125C1RV | |
| | 425 | | 1500 x 640 x 500 | | - 0425150C1RV | |
| | 450 | | 1600 x 640 x 500 | | - 0450160C1RV | |
| | 520 | | 1800 x 640 x 500 | | - 0520180C1RV | |
| | 570 | | 2000 x 640 x 500 | | - 0570200C1RV | |

* Full tank capacity ** Upon request

Accessories pp 34-35



63/70 (sidewalls 636 mm h x 706 mm w)

Mounting kit available:



Materials available:



Download specifics
www.padoan.it/documents/Padoan_DIESEL_63-70_EN.pdf

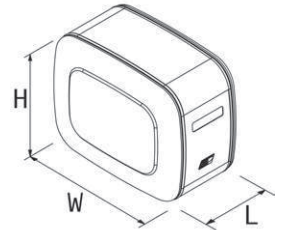

| Products range | LT* | Features included | Dimensions (only tank) L x H x W | Material | Product code NSGA: Aluminium NSGF: Painted steel NSGI: Stainless steel | Mounting kit code  |
|----------------|------------------|---|-------------------------------------|----------|---|--|
| 63/70 diesel | 110 | <ul style="list-style-type: none"> - fuel cap with key and breathing valve - bayonet connection (for VDO level indicator) - diesel drainage - homologation ECE34 Part III (side installation) | 300 x 636 x 706 | A/F/I | - 0120030C100 | Included |
| | 135 | | 350 x 636 x 706 | | - 0135035C100 | |
| | 200 | | 500 x 636 x 706 | | - 0200050C100 | |
| | 240 | | 610 x 636 x 706 | | - 0250061C100 | |
| | 290 | | 735 x 636 x 706 | | - 0300073C100 | |
| | 360 | | 900 x 636 x 706 | | - 0350090C100 | |
| | 400 | | 1000 x 636 x 706 | | - 0400100C100 | |
| | 450 | | 1110 x 636 x 706 | | - 0450111C100 | |
| | 500 | | 1250 x 636 x 706 | | - 0500125C100 | |
| | 550 | | 1360 x 636 x 706 | | - 0550136C100 | |
| | 600 | | 1500 x 636 x 706 | | - 0600150C100 | |
| | 650 | | 1610 x 636 x 706 | | - 0650161C100 | |
| | 670 | | 1700 x 636 x 706 | | - 0670170C100 | |
| 730 | 1800 x 636 x 706 | - 0700180C100 | | | | |
| 815 | 2000 x 636 x 706 | - 0800200C100 | | | | |

* Full tank capacity



70/63 (sidewalls 706 mm h x 636 mm w)**

Mounting kit available for:

SIDE

Materials available:



Aluminium



Painted Steel
RAL 7021



Stainless Steel



Download specifics

www.padoan.it/documents/Padoan_DIESEL_70-63_EN.pdf

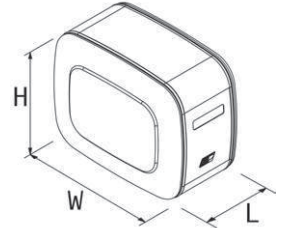

| Products range | LT* | Features included | Dimensions (only tank) L x H x W | Material | Product code NSGA: Aluminium NSGF: Painted steel NSGI: Stainless steel | Mounting kit code SIDE |
|----------------|------------------|---|-------------------------------------|----------|---|----------------------------------|
| 70/63 diesel | 110 | <ul style="list-style-type: none"> - fuel cap with key and breathing valve - bayonet connection (for VDO level indicator) - diesel drainage - homologation ECE34 Part III (side installation) | 300 x 706 x 636 | A/F/I | - 0110030C1RV | Included |
| | 135 | | 350 x 706 x 636 | | - 0135035C1RV | |
| | 200 | | 500 x 706 x 636 | | - 0200050C1RV | |
| | 240 | | 610 x 706 x 636 | | - 0240061C1RV | |
| | 290 | | 735 x 706 x 636 | | - 0290073C1RV | |
| | 360 | | 900 x 706 x 636 | | - 0360090C1RV | |
| | 400 | | 1000 x 706 x 636 | | - 0400100C1RV | |
| | 450 | | 1110 x 706 x 636 | | - 0450111C1RV | |
| | 500 | | 1250 x 706 x 636 | | - 0500125C1RV | |
| | 550 | | 1360 x 706 x 636 | | - 0550136C1RV | |
| | 600 | | 1500 x 706 x 636 | | - 0600150C1RV | |
| | 650 | | 1610 x 706 x 636 | | - 0650161C1RV | |
| | 670 | | 1700 x 706 x 636 | | - 0670170C1RV | |
| | 730 | | 1800 x 706 x 636 | | - 0730180C1RV | |
| 815 | 2000 x 706 x 636 | - 0800200C1RV | | | | |

* Full tank capacity ** Upon request



70/70 (sidewalls 700 mm h x 700 mm w)

Mounting kit available for:

SIDE

Materials available:

| | |
|-----------|---------------------------|
| A | F |
| Aluminium | Painted Steel RAL 7021 |



Download specifics
www.padoan.it/documents/Padoan_DIESEL_70-70_EN.pdf

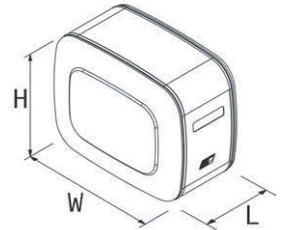

| Products range | LT* | Features included | Dimensions (only tank) L x H x W | Material | Product code NSGA: Aluminium NSGF: Painted steel | Mounting kit code SIDE |
|----------------|------------------|---|-------------------------------------|----------|--|----------------------------------|
| 70/70 diesel | 125 | <ul style="list-style-type: none"> - fuel cap with key and safety valve - bayonet connection for VDO level indicator) - diesel drainage - homologation ECE34 Part III (side installation) | 300 x 700 x 700 | A/F | - 0140030C100 | Included |
| | 160 | | 350 x 700 x 700 | | - 0160035C100 | |
| | 170 | | 400 x 700 x 700 | | - 0190040C100 | |
| | 200 | | 450 x 700 x 700 | | - 0200045C100 | |
| | 215 | | 500 x 700 x 700 | | - 0230050C100 | |
| | 260 | | 600 x 700 x 700 | | - 0280060C100 | |
| | 310 | | 700 x 700 x 700 | | - 0330070C100 | |
| | 350 | | 800 x 700 x 700 | | - 0370080C100 | |
| | 400 | | 900 x 700 x 700 | | - 0400090C100 | |
| | 445 | | 1000 x 700 x 700 | | - 0460100C100 | |
| | 500 | | 1100 x 700 x 700 | | - 0500110C100 | |
| | 540 | | 1200 x 700 x 700 | | - 0550120C100 | |
| | 590 | | 1300 x 700 x 700 | | - 0600130C100 | |
| | 680 | | 1500 x 700 x 700 | | - 0700150C100 | |
| | 815 | | 1800 x 700 x 700 | | - 0800180C100 | |
| 910 | 2000 x 700 x 700 | - 0900200C100 | | | | |
| 960 | 2110 x 700 x 700 | - 0960211C100 | | | | |

* Full tank capacity

Accessories pp 34-35

combined tanks



50/64 (sidewalls 500 mm h x 640 mm w)**





Download specifics
www.padoan.it/documents/Padoan_COMBINED_50-64_EN.pdf

Mounting kit available:

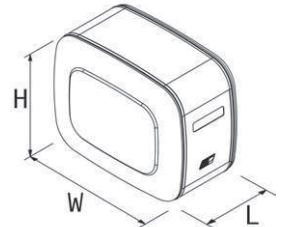
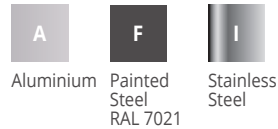

Materials available:



| Products range | LT* diesel / oil | Features included | Filter flange code (oil) | Dimensions (only tank) L x H x W | Material | Product code NSMA: Aluminium NSMF: Painted steel NSMI: Stainless steel | Mounting kit code  |
|---------------------------------------|------------------|--|--------------------------|----------------------------------|----------|---|--|
| 50/64 combined Multi Function (MF) | 160/120 | diesel - fuel cap with key and breathing valve - bayonet connection (for VDO level indicator) | 135 | 1000 x 500 x 640 | A/F/I | - 0160100C100 | Included |
| | 175/105 | - diesel drainage - homologation ECE34 Part III (side installation) | | | | - 0175100C100 | |
| | 190/90 | oil - spy eye 1" - suction connection 1" 1/2 - air breather cap h 41mm - adjustable ball valve 1" 1/2 | | | | - 0191100C100 | |

* Full tank capacity ** Upon request

Accessories (oil partition) pp 30-32
 Accessories (diesel partition) pp 34-35



64/50 (sidewalls 640 mm h x 500 mm w)

Mounting kit available:

SIDE

Materials available:

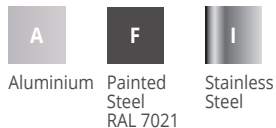

Aluminium

Painted
Steel
RAL 7021

Stainless
Steel



Download specifics

www.padoan.it/documents/Padoan_COMBINED_64-50_EN.pdf

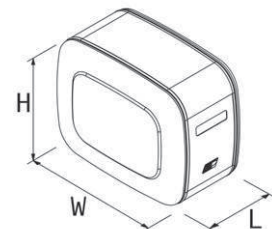

| Products range | LT* diesel / oil | Features included | Filter flange code (oil) | Dimensions (only tank) L x H x W | Material | Product code NSMA: Aluminium NSMF: Painted steel NSMI: Stainless steel | Mounting kit code SIDE |
|--|---------------------|--|--------------------------|-------------------------------------|----------|---|----------------------------------|
| 64/50 combined Multi Function (MF) | 160/120 | diesel - fuel cap with key and breathing valve - bayonet connection (for VDO level indicator) | 135 | 1000 x 640 x 500 | A/F/I | - 0160100C1RV | Included |
| | 175/105 | - diesel drainage - homologation ECE34 Part III (side installation) | | | | - 0175100C1RV | |
| | 190/90 | oil - spy eye 1" - suction connection 1" 1/2 - air breather cap h 41mm - adjustable ball valve 1" 1/2 | | | | - 0191100C1RV | |

* Full tank capacity

Accessories (oil partition) pp 30-32
Accessories (diesel partition) pp 34-35

63/70 (sidewalls 636 mm h x 706 mm w)



Mounting kit available:

SIDE

Materials available:

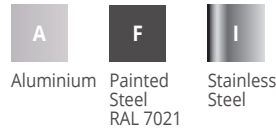

Download specifics
www.padoan.it/documents/Padoan_COMBINED_63-70_EN.pdf

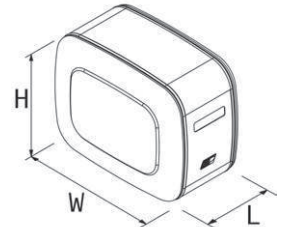

| Products range | LT* diesel / oil | Features included | Filter flange code (oil) | Dimensions (only tank) L x H x W | Material | Product code NSMA: Aluminium NSMF: Painted steel NSMI: Stainless steel | Mounting kit code SIDE |
|---------------------------------------|------------------|--|--------------------------|----------------------------------|----------|---|----------------------------------|
| 63/70 combined Multi Function (MF) | 125/140 | diesel - fuel cap with key and breathing valve - bayonet connection (for VDO level indicator) - diesel drainage - homologation ECE34 Part III (side installation) oil - spy eye 1" - suction connection 1" 1/2 - air breather cap h 41mm - adjustable ball valve 1" 1/2 | 135 | 700 x 636 x 706 | A/F/I | - 0125070C100 | Included |
| | 140/170 | | | 800 x 636 x 706 | | - 0140080C100 | |
| | 160/150 | | | 800 x 636 x 706 | | - 0160080C100 | |
| | 180/170 | | | 900 x 636 x 706 | | - 0180090C100 | |
| | 190/200 | | | 1000 x 636 x 706 | | - 0190100C100 | |
| | 200/150 | | | 900 x 636 x 706 | | - 0200091C100 | |
| | 220/170 | | | 1000 x 636 x 706 | | - 0220100C100 | |
| | 280/200 | | | 1250 x 636 x 706 | | - 0280125C100 | |
| | 380/200 | | | 1500 x 636 x 706 | | - 0380150C100 | |
| | 410/170 | | | 1500 x 636 x 706 | | - 04100150C100 | |
| 600/200 | 2000 x 636 x 706 | - 0600200C100 | | | | | |
| 63/70 combined EVO | 125/140 | diesel - fuel cap with key and breathing valve - bayonet connection (for VDO level indicator) - diesel drainage - homologation ECE34 Part III (side installation) oil - level indicator part of Evo Filter - suction connection 1" 1/2 - adjustable ball valve 1" 1/2 | Evo | 700 x 636 x 706 | A/F/I | - 0125070CE00 | Included |
| | 140/170 | | | 800 x 636 x 706 | | - 0140080CE00 | |
| | 160/150 | | | 800 x 636 x 706 | | - 0160080CE00 | |
| | 180/170 | | | 900 x 636 x 706 | | - 0180090CE00 | |
| | 190/200 | | | 1000 x 636 x 706 | | - 0190100CE00 | |
| | 200/150 | | | 900 x 636 x 706 | | - 0200091CE00 | |
| | 220/170 | | | 1000 x 636 x 706 | | - 0220100CE00 | |
| | 280/200 | | | 1250 x 636 x 706 | | - 0280125CE00 | |
| | 380/200 | | | 1500 x 636 x 706 | | - 0380150CE00 | |
| | 410/170 | | | 1500 x 636 x 706 | | - 04100150CE00 | |
| 600/200 | 2000 x 636 x 706 | - 0600200CE00 | | | | | |

* Full tank capacity

combined tanks



70/70 (sidewalls 700 mm h x 700 mm w)

Mounting kit available:

SIDE

Materials available:



Download specifics
www.padoan.it/documents/Padoan_COMBINED_70-70_EN.pdf

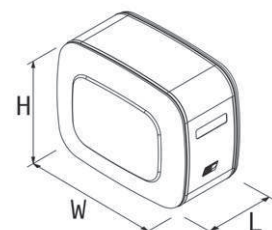

| Products range | LT* diesel / oil | Features included | Filter flange code (oil) | Dimensions (only tank) L x H x W | Material | Product code NSMA: Aluminium NSMF: Painted steel | Mounting kit code SIDE |
|---|------------------|---|--------------------------|----------------------------------|---------------|--|----------------------------------|
| 70/70 combined Multi Function (MF) | 150/150 | diesel | 135 | 700 x 700 x 700 | A/F | - 0150070C100 | Included |
| | 200/150 | - fuel cap with key and breathing valve | | 800 x 700 x 700 | | - 0200080C100 | |
| | 200/200 | - bayonet connection (for VDO level indicator) | | 900 x 700 x 700 | | - 0200090C100 | |
| | 220/170 | - diesel drainage | | 900 x 700 x 700 | | - 0220090C100 | |
| | 280/170 | - homologation ECE34 Part III (side installation) | | 1000 x 700 x 700 | | - 0280100C100 | |
| | 300/200 | oil | | 1100 x 700 x 700 | | - 0300110C100 | |
| | 340/200 | - spy eye 1" | | 1200 x 700 x 700 | | - 0340120C100 | |
| | 400/200 | - suction connection 1" 1/2 | | 1300 x 700 x 700 | | - 0400130C100 | |
| | 480/200 | - air breather cap h 41mm | | 1500 x 700 x 700 | | - 0480150C100 | |
| | 600/200 | - adjustable ball valve 1" 1/2 | | 1800 x 700 x 700 | | - 0600180C100 | |
| | 700/200 | | 2000 x 700 x 700 | | - 0700200C100 | | |

* Full tank capacity

Accessories (oil partition) pp 30-32
Accessories (diesel partition) pp 34-35

accessories oil tanks



Semi-immersed Return Filters

for all tanks excluded 26/36, 36/26, 70/70R and Evo



| | | | | Oil and combined tanks | |
|---------------|------------|-----------------------------|------------------|------------------------|-----------------------|
| Filter Flange | l/min flow | Micron / μm | Inlet Connection | Product Code | Spare Parts Cartridge |
| 135 | 250 l/min | 40 μm microfibre | 1"1/4 | AFO0SEM136125CF | AFO0ELF205070CF |
| | 200 l/min | 21 μm microfibre | 1"1/4 | AFO0SEM136125F2 | AFO0ELF205070F2 |
| | 150 l/min | 10 μm paper | 1"1/4 | AFO0SEM136125C1 | AFO0ELF205070C1 |
| 195 | 300 l/min | 60 μm wire mesh | 1"1/4 | AFO0SEM195125CL | AFO0ELF210100RM |
| | 250 l/min | 21 μm microfibre | 1"1/4 | AFO0SEM195125F2 | AFO0ELF211099F2 |
| | 250 l/min | 10 μm paper | 1"1/4 | AFO0SEM19512510 | AFO0ELF211099C1 |
| 195 | 300 l/min | 60 μm wire mesh | 1"1/4 + 3/4" | AFO0SEM195225CL | AFO0ELF210100RM |
| | 250 l/min | 21 μm microfibre | 1"1/4 + 3/4" | AFO0SEM195225F2 | AFO0ELF211099F2 |
| | 250 l/min | 10 μm paper | 1"1/4 + 3/4" | AFO0SEM19522510 | AFO0ELF211099C1 |

only for 26/36 - 36/26 oil tanks

| | | | | | |
|-----|-----------|-----------------------------|----|-----------------|-----------------|
| 135 | 150 l/min | 60 μm wire mesh | 1" | AFO0SEM135100ST | AFO0ELF128070BF |
| | 125 l/min | 21 μm microfibre | 1" | AFO0SEM135100F2 | AFO0ELF13007025 |

*** Immersed Return Filters for Easy Kit**

for all tanks excluded 26/36, 36/26, 70/70R, Evo and monobacket



| | | | | Oil and combined tanks | |
|---------------|------------|-----------------------------|------------------|------------------------|-----------------------|
| Filter Flange | l/min flow | Micron / μm | Inlet Connection | Product Code | Spare Parts Cartridge |
| 135 | 250 l/min | 40 μm microfibre | / | AFO0IMM090340CF | AFO0ELF205070CF |
| | 200 l/min | 21 μm microfibre | / | AFO0IMM090340F2 | AFO0ELF205070F2 |
| | 150 l/min | 10 μm paper | / | AFO0IMM090340C1 | AFO0ELF205070C1 |

only for 26/36 - 36/26 oil tanks

| | | | | | |
|-----|-----------|-----------------------------|----|-----------------|-----------------|
| 135 | 150 l/min | 60 μm wire mesh | 1" | AFO0IMM090240RM | AFO0ELF142070RM |
| | 125 l/min | 21 μm microfibre | 1" | AFO0IMM090240F2 | AFO0ELF142070F2 |

* Customized valve plates are available on request according to your tipping valve hole layout.

Immersed Easy Filters

for all tanks excluded 26/36, 36/26, 70/70R, Evo and monobacket



| | | | | Oil and combined tanks | |
|---------------|------------|-----------------------------|------------------|------------------------|-----------------------|
| Filter Flange | l/min flow | Micron / μm | Inlet Connection | Product Code | Spare Parts Cartridge |
| 135 | 220 l/min | 40 μm microfibre | 1" | AFO0IMM134100CF | AFO0ELF205070CF |
| | 180 l/min | 21 μm microfibre | 1" | AFO0IMM134100F2 | AFO0ELF205070F2 |
| | 150 l/min | 10 μm paper | 1" | AFO0IMM134100C1 | AFO0ELF205070C1 |

only for 26/36 - 36/26 oil tanks

| | | | | | |
|-----|-----------|-----------------------------|----|-----------------|-----------------|
| 135 | 150 l/min | 60 μm wire mesh | 1" | AFO0IMM134101ST | AFO0ELF142070RM |
| | 125 l/min | 21 μm microfibre | 1" | AFO0IMM134101F2 | AFO0ELF142070F2 |

Evo Filters

| | | | | Oil and combined tanks | |
|---------------|------------|-----------------------------|------------------|------------------------|-----------------------|
| Filter Flange | l/min flow | Micron / μm | Inlet Connection | Product Code | Spare Parts Cartridge |
| Evo | 220 l/min | 40 μm microfibre | 1"1/4 | AFO0SFL251125CF | AFO0ELF255059F4 |
| | 180 l/min | 21 μm microfibre | 1"1/4 | AFO0SFL251125F2 | AFO0ELF255059F2 |
| | 150 l/min | 10 μm paper | 1"1/4 | AFO0SFL251125CC | AFO0ELF255059C1 |

In-line filters



| | | | Oil and combined tanks | |
|------------|-----------------------------|------------------|------------------------|-----------------------|
| I/min flow | Micron / μm | Inlet connection | Product Code | Spare Parts Cartridge |
| 150 l/min | 25 μm microfibre | 1" | AFOOLIN000100F2 | AFO0ELF177096F2 |
| 230 l/min | 60 μm wire mesh | 1" 1/4 | AFOOLIN000100RM | AFO0ELF177096RM |
| 170 l/min | 25 μm microfibre | 1" | AFOOLIN000125F2 | AFO0ELF177096F2 |
| 270 l/min | 60 μm wire mesh | 1" 1/4 | AFOOLIN000125RM | AFO0ELF177096RM |

Filter's clogging visual indicator



| | | | Oil and combined tanks | |
|----------------|------------------------------------|-------------------|------------------------|-------------|
| Products Range | Description | Specifics | Product Code | Spare Parts |
| Oil tanks | Filter's clogging visual indicator | R 1/8" - EN 10226 | AII0MPF195VSR42 | / |

Aluminium cover with return connection and pipe for all tanks with filter flange 135, monobacket excluded





| | | | Oil and combined tanks | |
|----------------|-----------------------|-------------------------------|------------------------|-------------|
| Products Range | Description | Specifics | Product Code | Spare Parts |
| Oil tanks | Aluminium cover 160mm | 1" return connection and pipe | ACFA1604F010027 | / |

Air breather caps



| | | | Oil and combined tanks | |
|--|---|--|------------------------|-----------------------|
| Products Range | Description | Specifics | Product Code | Spare Parts Cartridge |
| MF / Monobacket / Compact 75lt - 90lt / T20 / MFPG | Air breather cap with air filter, fixing screws and anti-splash | h 41 mm - air cartridge paper 10 μm | ATPOPLSCAR0LI20 | AFA0CARCILTOP20 |
| RC / RC30 | Air breather cap with air filter, fixing screws and anti-splash | h 69 mm - air cartridge paper 10 μm | ATPOPLSCAR0LI10 | AFA0CARCILTOP10 |

Level indicators

| | | | Oil and combined tanks | | |
|---|--|-----------------------------|--|-----------------|---|
| Products Range | Description | Specifics | Product Code | Spare Parts | |
|  | MF / Monobracek / Compact / MFPG / Classic | round aluminium level gauge | 1" | AILOROTLIQ100AL | / |
| | 26/36 / 36/26 | round aluminium level gauge | 3/4" | AILOROTLIQ075AL | / |
|  | MF (44/54 60-70lt) | sight level gauge | not graduated - 127 mm distance between centers (M12) | AILOVISLIQ12701 | / |
| | T20* | sight level gauge | not graduated - 254 mm distance between centers (M12) | AILOVISLIQ25400 | / |
| | | | not graduated - 254 mm distance between centers (M12)- low level electric sensor, 2,5 mm wire connection | AILOVISLIQ254CE | / |
| | | | graduated - 254 mm distance between centers (M12) - with thermometer | AILOVISLIQ254TR | / |

* not included in the standard tank

Adjustable ball valves

| | | | Oil and combined tanks | | |
|--|-------------------------------------|-------------------------------------|------------------------|-----------------|---|
| Products Range | Description | Specifics | Product Code | Spare Parts | |
|  | Oil tanks | adjustable ball valve MF with lever | 1"1/4 | ARU0ABV12500100 | / |
| | | adjustable ball valve MF with lever | 1"1/2 | ARU0ABV15000100 | / |
| | | adjustable ball valve MF with lever | 2" | ARU0ABV20000100 | / |
| | | adjustable ball valve MF with lever | 2"1/2 | ARU0ABV25000100 | / |
| Fits with 26/36 and 36/26 oil tanks | | | | | |
| Oil Tanks | adjustable ball valve MF with lever | 1"1/4 | ARU0ABV12500100 | | |

Pipe fittings

| | | | Oil and combined tanks | | |
|---|-------------|---|------------------------|-----------------|---|
| Products Range | Description | Specifics | Product Code | Spare Parts | |
|  | Oil tanks | straight pipe fitting, Ø40mm HOSE, inox band and sealing | 1"1/4 | ARA0PDNPGM12500 | / |
| | | straight pipe fitting, Ø51mm HOSE, inox band and sealing | 1"1/2 | ARA0PDNPGM15000 | / |
| | | straight pipe fitting, Ø65mm HOSE, inox band and sealing | 2" | ARA0PDNPGM20000 | / |
| | | straight pipe fitting, Ø64mm HOSE, steel painted | 2" 1/2 | ARA0RR0PGM25000 | / |
| | | straight pipe fitting, Ø75mm HOSE, steel painted | 2" 1/2 | ARA0RR0PGM25010 | / |
| | | 90° adjustable pipe fitting, Ø40mm HOSE connection, inox band and sealing | 1"1/4 | ARA0PDNPGM12550 | / |
| | | 90° adjustable pipe fitting, Ø51mm HOSE connection, inox band and sealing | 1"1/2 | ARA0PDNPGM15050 | / |
| | | 90° adjustable pipe fitting, Ø65mm HOSE connection, inox band and sealing | 2" | ARA0PDNPGM20050 | / |

Adjustable fittings

| | | | Oil and combined tanks | | |
|---|-------------|----------------------------|------------------------|-----------------|---|
| Products Range | Description | Specifics | Product Code | Spare Parts | |
|  | Oil tanks | 90° adjustable fitting M/F | 1"1/4 | ARA0PDNFLT12550 | / |
| | | 90° adjustable fitting M/F | 1"1/2 | ARA0PDNFLT15050 | / |
| | | 90° adjustable fitting M/F | 2"1/2 | ARA0PDNFLT25050 | / |

accessories diesel tanks



Diesel level indicators (for Padoan tanks)

| | | | Diesel oil and combined tanks | |
|---|------------------|---|--|-------------------|
| Products Range | Description | Specifics | Product Code | Spare Parts |
|  | Diesel oil tanks | Diesel level indicator 250 mm lenght | Suction and return 10mm, bayonet connection, 4PIN socket connector with switch low level connection | AIC0GENVD025030 / |
| | | Diesel level indicator 430 mm lenght | Suction and return 10mm, bayonet connection, 4PIN socket connector with switch low level connection | AIC0GENVD043030 / |
| | | Diesel level indicator 490 mm lenght | Suction and return 10mm, bayonet connection, 4PIN socket connector with switch low level connection | AIC0GENVD049030 / |
| | | Diesel level indicator 620 mm lenght | Suction and return 10mm, bayonet connection, 4PIN socket connector with switch low level connection | AIC0GENVD062030 / |
| | | Diesel level indicator 690 mm lenght | Suction and return 10mm, bayonet connection, 4PIN socket connector with switch low level connection | AIC0GENVD069030 / |

Analogic cabin diesel oil indicator (to be installed with the generic level oil indicator and Padoan tanks)

| | | | Diesel oil and combined tanks | |
|---|------------------|--|-------------------------------------|-------------------|
| Products Range | Description | Specifics | Product Code | Spare Parts |
|  | Diesel oil tanks | Cabin fuel level indicator (to be installed with Padoan tank and diesel level indicator) | Round screen with reserve signal | AILOGENPDN00000 / |

Diesel connection kits

| | | | Diesel oil and combined tanks | |
|--|------------------|--|--|-------------------|
| Products Range | Description | Specifics | Product Code | Spare Parts |
|  | Diesel oil tanks | Connection kit for diesel tank Pipe lenght 1.500 mm | no. 2 3/4" elbows, no. 2 3/4" valves, no. 2 rubber holders with lenght 12 mm, no. 1 pipe with 12 mm diameter and 1.500 mm lenght | AKA0ABBGAS07500 / |
| | | Connection kit for diesel tank Pipe lenght 3.000 mm | no. 2 3/4" elbows, no. 2 3/4" valves, no. 2 rubber holders with lenght 12 mm, no. 1 pipe with 12 mm diameter and 3.000 mm lenght | AKA0ABBGAS07501 / |

Fuel caps
included

| | | | Diesel oil and combined tanks | |
|---|---|-------------------------------------|-------------------------------|-------------|
| Products Range | Description | Specifics | Product Code | Spare Parts |
|  <p>Diesel oil tanks</p> | Fuel Cap, diameter 80 mm, with bayonet connection | with key and safety valve - plastic | ATP0CARCARB80CE | / |

optional not included

| | | | | |
|---|--|-------------------------------------|-----------------|---|
|  <p>Diesel oil tanks</p> | Fuel Cap, diameter 80mm, with bayonet connection | with key and safety valve - plastic | ATP0CARCARB80CV | / |
|---|--|-------------------------------------|-----------------|---|

VDO Cap

| | | | Diesel oil and combined tanks | |
|---|-----------------------------|--------------------------------|-------------------------------|-------------|
| Products Range | Description | Specifics | Product Code | Spare Parts |
|  <p>Diesel oil tanks</p> | Cap with bayonet connection | equipped with cover and rubber | ATP0COPATTVDOPC | / |

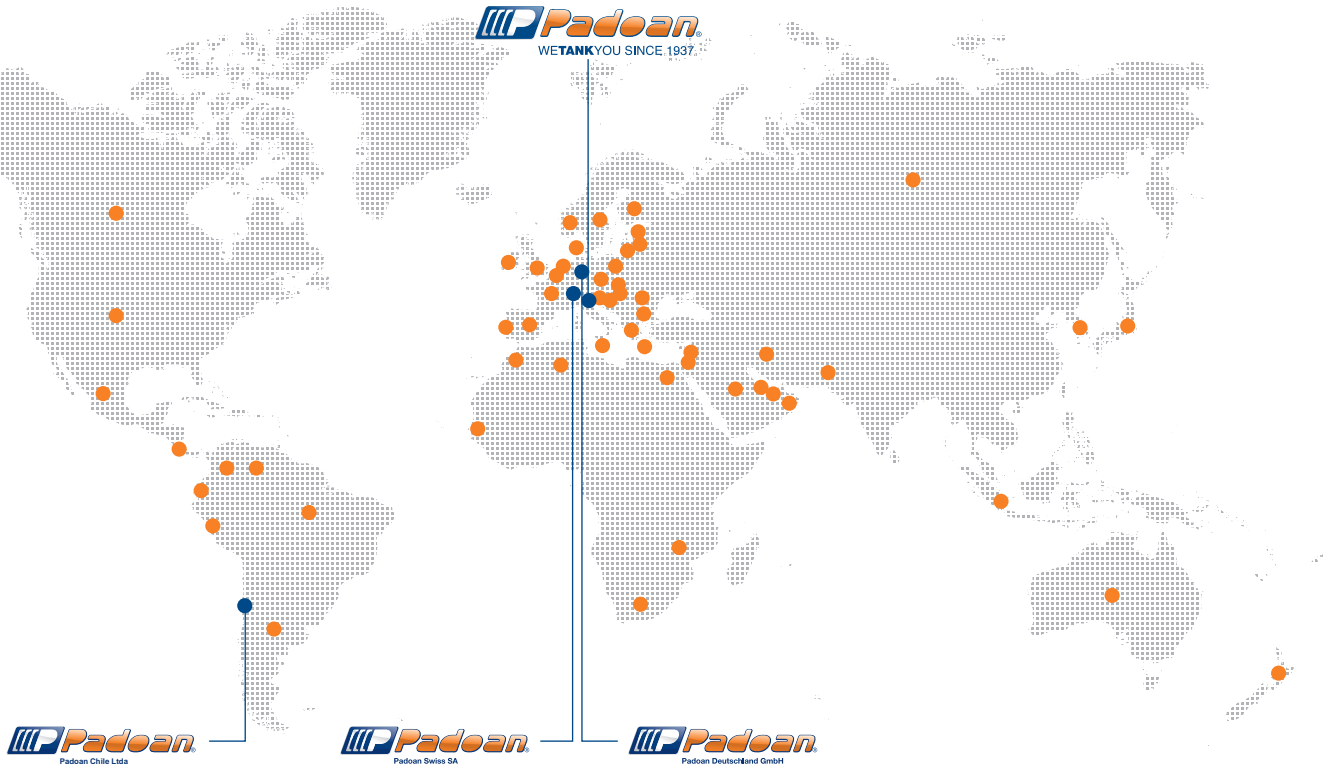

in the world



Padoan Srl
 Via Risorgive, 20
 31048 Olmi di S. Biagio di Callalta (TV) - Italy
 ph. +39 0422 362172
 info@padoan.it - www.padoan.it

Padoan Swiss SA
 San Vittore, Cantone Grigioni - Switzerland

Padoan Deutschland GmbH
 Mönchengladbach - Germany

Padoan Chile Ltda
 Santiago - Chile

