

DPS Series digital display pressure sensor



Symbol



User interface Instruction

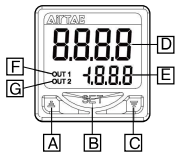

No.	Item
A	Value up button
B	Setting button
C	Value Down button
D	Pressure display area
E	Set pressure display area
F	Output 1 indicator light
G	Output 2 indicator light
H	Power and signal connector
J	Pressure input

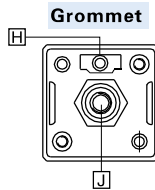
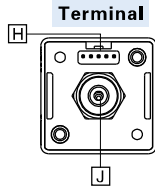

Output on the bottom

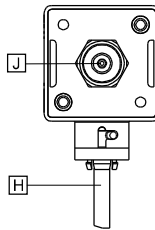

Specification

Input power	Voltage	12~24 VDC ± 10% Ripple(p-p) < 10%
Pressure range	Fluid	Non-corrosive gas
	Measurement range	DPSN1(P1)-01: -100kPa~100kPa
		DPSN1(P1)-10: -100kPa~1,000kPa
	Withstand pressure	DPSN1(P1)-01: 200kPa
		DPSN1(P1)-10: 1500kPa
Measurement error	± 2% F.S. , ± 1digit(Temperature:25 ± 3°C)	
Repetitive accuracy	± 0.2% F.S.	
Temperature error	± 3% F.S.(Base 25°C, Range 0 to 50°C)	
Display	Type	Double row LCD display,4-digit measurement, 3.5-digit setting
	Color	2-color LCD (Red/Green)
	Display period	100ms、250ms、500ms、1,000ms
Output group	Output group	DPSN1:Built-in two sets of NPN output DPSP1:Built-in two sets of PNP output
	Transistor output	NPN:Maximum applied voltage 30V/100mA,Retained voltage <1.5V
		PNP:Maximum applied voltage 30V/100mA,Retained voltage <1.5V
	Output delay time	2ms、20ms、50ms、100ms、250ms、500ms 1,000ms、2,500ms、5,000ms
		Hysteresis
Output mode	Basic mode, Hysteresis mode, Window comparator mode	
	Pressure Unit	DPSN1(P1)-01: kPa、kgf/cm ² 、bar、psi、mmHg、inHg DPSN1(P1)-10: MPa、kPa、kgf/cm ² 、bar、psi、cmHg、inHg
Vibration resistance	10 to 500Hz with 10mm Amplitude in X, Y, Z directions for 2hrs	
	Impact resistance Maximum 100m/s ² , X, Y, Z directions 3 times each	
Operating Temp. range	0~50°C	
Stored Temp. range	-20~65°C	
Humidity range	35%~80% RH(No condensation)	

Ordering code

DPS N1 □ -01 020 G

① ② ③ ④ ⑤ ⑥

① Model	② Output type	③ Electrical entry	④ Measurement range	⑤ Lead wire length	⑥ Piping specifications
DPS: Digital Display Pressure Sensor	N1: NPN P1: PNP	Space: Plug-in type B: Pre-wired type [Note1] D: Output on the bottom type	01: -100kPa~100kPa 10: -100kPa~1,000kPa	020: Length 2m 030: Length 3m 050: Length 5m M08:300mm with M8 plug connector[Note2]	G: Male thread G1/8; female thread: M5

[Note1] The safety grade of pre-wired type is IP63.

[Note2] There is no plug-in type for M08.

The sockets of M08 need additional order. Please check on the right.

Ordering code of Socket **F - EC M08 D 020**



Catagory code	F: Accessory
Type code	EC: Connecting wire
Socket type	M08:M8 socket
Wire type	D: 4-wire type
Wire length	020: 2 meters 030:3meters 050:5meters 100:10meters

DPS Series digital display pressure sensor

Dimensions

Plug-in type

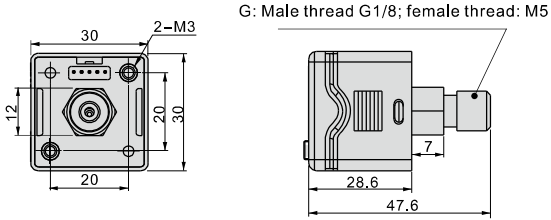

Pre-wired type

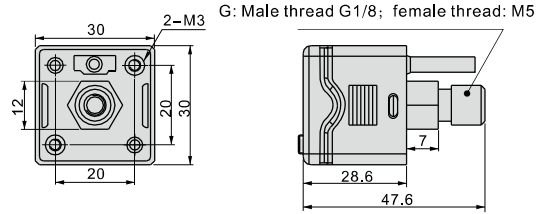

Output on the bottom type

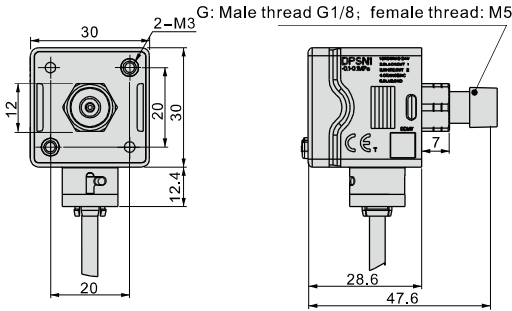

Dimensions/Assembly Instruction

Panel mount adapter + Front protective cover

Order the Installation accessories
(Ordering code: F-DPSEB, applicable to terminal and grommet type)

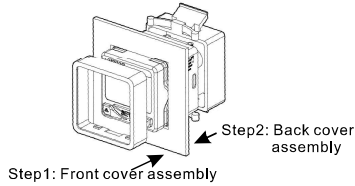
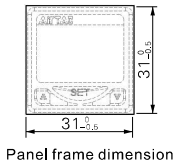

Order the Installation accessories
(Ordering code: F-DPSEB, applicable to bottom ported type)

Applicable panel thickness(T): 1~5mm

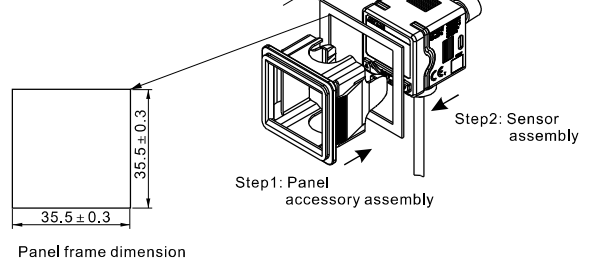

Bracket

Order the installation accessories (Ordering code: F-DPSLB)

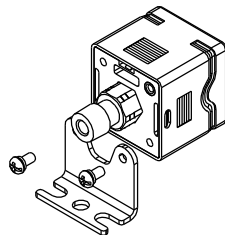
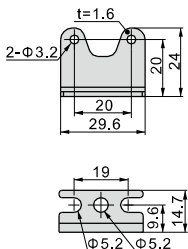

DPS Series digital display pressure sensor

User Interface Instructions

1. Mode switch

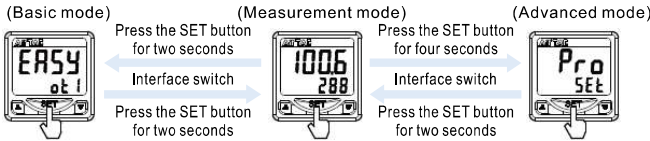

2. Basic mode

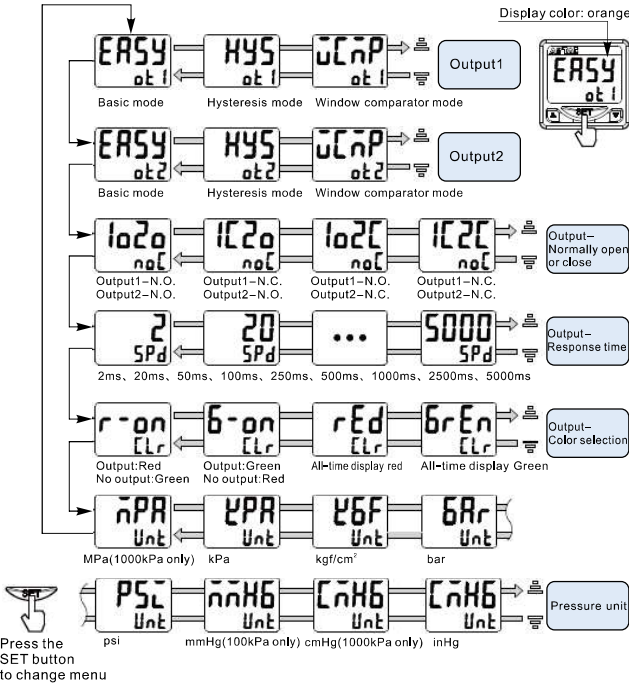

3. Base mode pressure setting

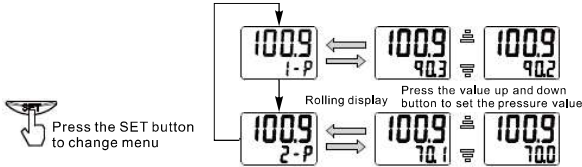

4. Hysteresis /window comparator mode

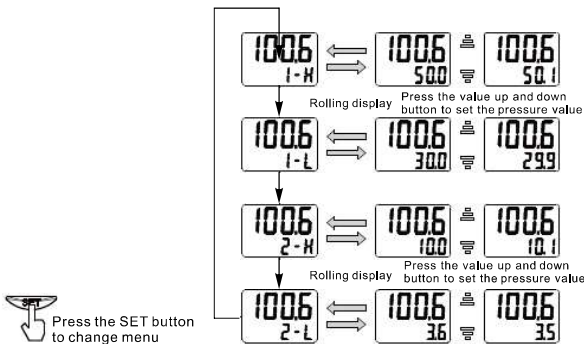

5. Interface of advanced mode

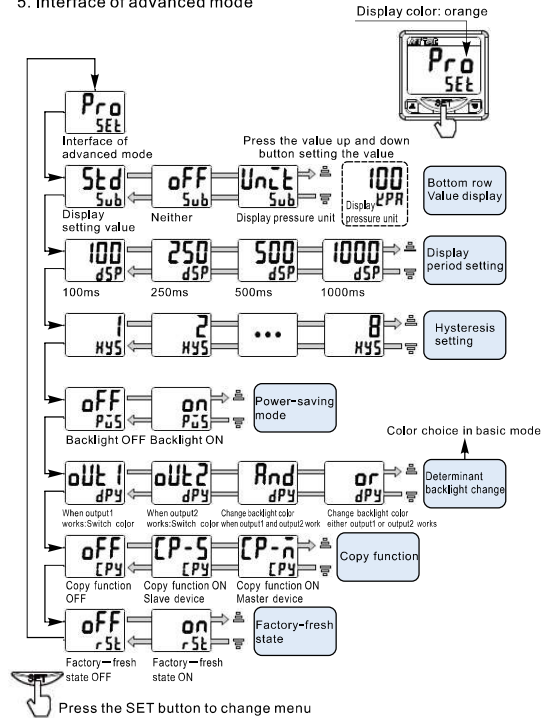

6. Copy function

- Hardware: Connect the second pin of master device with the third pin of slave device, then power on after connecting.
- Software: Set "CP-M" on master device. Set "CP-S" on slave device.
- Icon of copy completed. Repeat step 1 and 2 if copy failed.
- Turn off the power, disconnected devices and restart it after setting.

7. Zero-Clear Function

Press up and down simultaneously to reset the display value to zero.

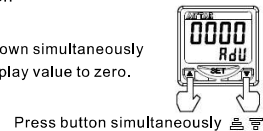

8. Key lock Function

- Press up and the set button simultaneously. Release it when the display turns to "LoCK on".
- Press down and simultaneously + Set buttons simultaneously + Set button the set button simultaneously. Release it when the display turns to "LoCK OFF".
- Press any button will display "LoCK" in lock on mode.

DPS Series digital display pressure sensor

Output mode

1. **Basic mode:** Air pressure setting value 'P'. When air pressure large then (Setting value P+Hysteresis value), the output is 'NO'; When air pressure less than setting value 'P', the output is 'OFF'.

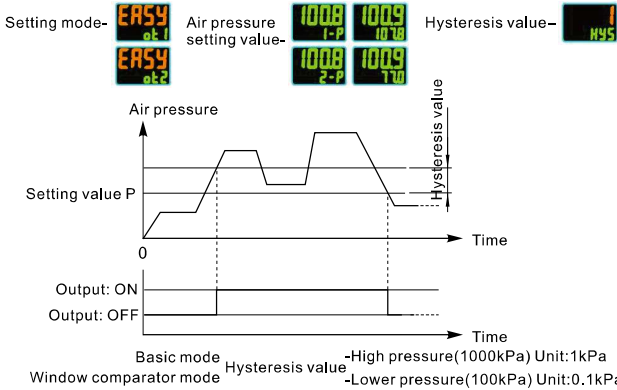

2. **Hysteresis mode:** Air pressure setting value 'H/L'. When air pressure large then setting value 'H', the output is 'NO'; When air pressure less than setting value 'L', the output is 'OFF'.

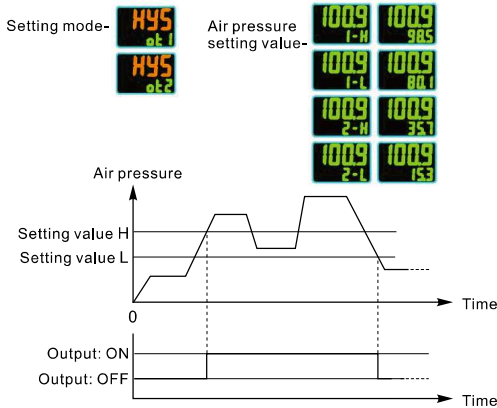

3. **Window comparator mode:** Air pressure setting value 'H/L'. When air pressure large then value 'H' or less then value 'L', the output is 'OFF'; When air pressure large then value 'L' and less than value 'H', the output is 'ON'.

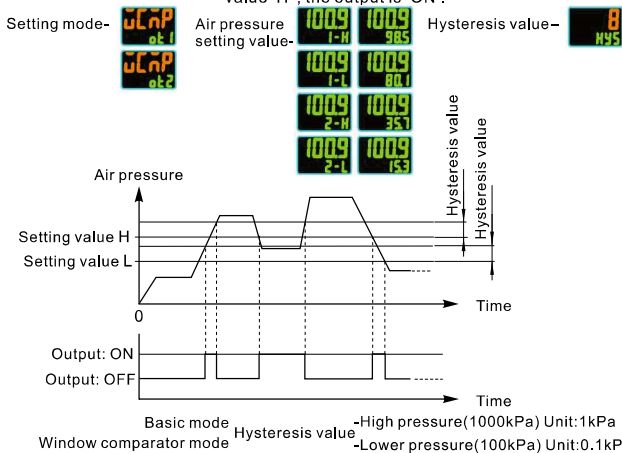

Connection Example

NPN Output

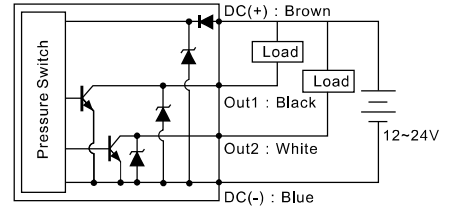

PNP Output

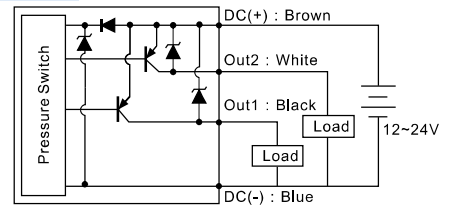

Notes

- Do not drop, knock or apply excessive impact while handling. Otherwise could cause damage and a malfunction.
- The tensile strength of the cord is 60N. Applying a greater pulling force on it can cause a malfunction.
- Do not exceed the screw-in torque of 7N.m when installing piping. Exceeding this value may cause malfunctioning of the sensor.
- Do not use it with corrosive and/or flammable gases or liquids.
- Please use it within rated pressure range.
- Turn off the power before connecting the wires.
- Don't use in an environment with spattering liquid of oil or solvent.
- Separate power lines from high voltage lines, avoiding wiring in the same conduit with these lines.
- When output current exceeds 100mA, circuit protection will be activated. System will resume once reboot.
- Adjust output-response response time can avoid errors caused by sudden change of working pressure.
- There is no copy function for PNP type.