

General technical information on centrifugal clutches and brakes

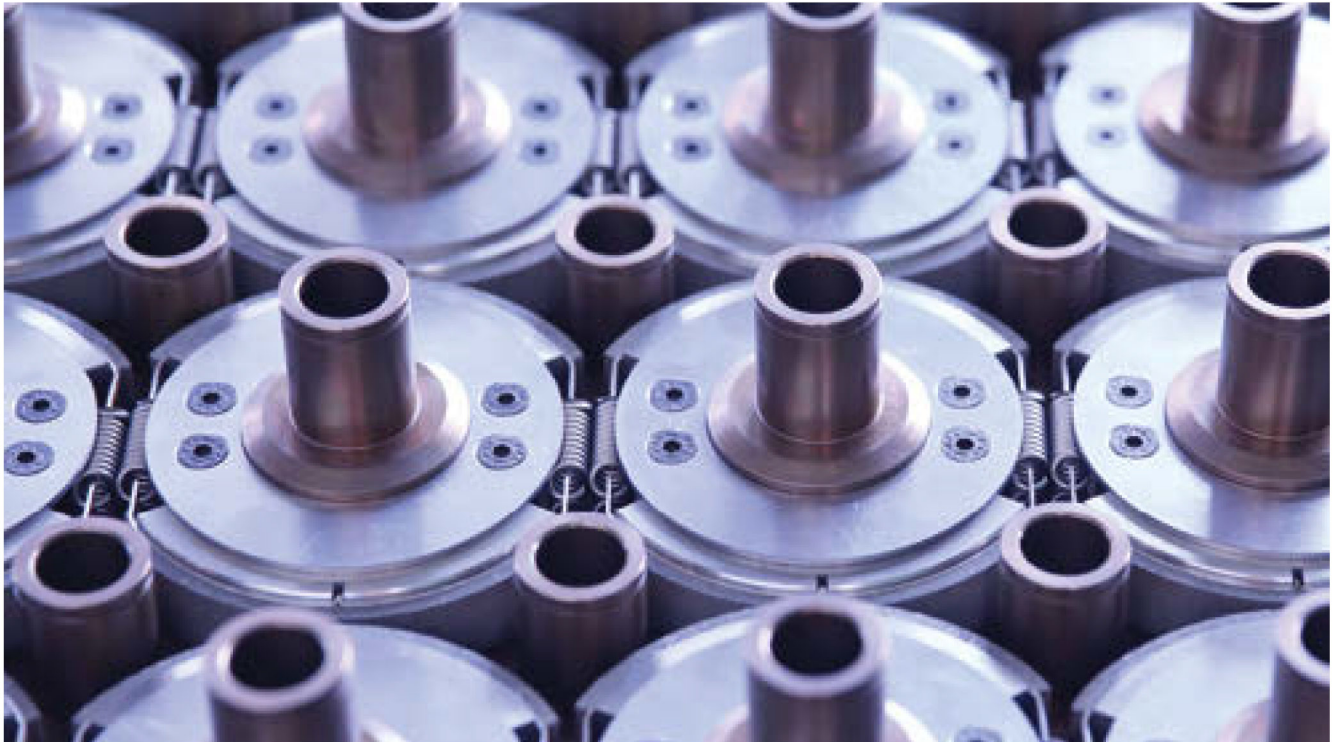

How do centrifugal clutches or brakes work?

Centrifugal clutches and brakes use centrifugal forces to transmit power (clutch) or to limit speed (brake).

As the brakes are based on a physical principle, centrifugal clutches or brakes **do not require any additional external power supply**, which makes them a perfect solution for safety applications.

Centrifugal clutches and brakes consist of a **driving shaft** ①. Around the driving shaft, there are **flyweights** ② mounted, which are kept on the shaft by **springs** ③. On the outer side of the flyweights there are **friction pads** ④.

1. When the driving shaft starts turning, the flyweights and the friction pads are kept together by the retaining forces of the springs.

2. At a predefined speed (engagement speed), the centrifugal forces overcome the retaining forces of the springs and the friction pads do contact **the outer drum** ⑤.

3. The friction pads begin to transmit power to the drum, but will show a slipping effect until the speed is further increased to the operating speed, which means a non-slip torque transmission.

Based on long experience and know-how, SUCO designs the clutches with a safety factor, which guarantees that the transmissible torque at the operating speed is higher than necessary. This ensures a slip free application and thus, reduces wear and service requirements.

Differences between a centrifugal clutch and a centrifugal brake:

The main difference between a centrifugal clutch and a centrifugal brake is in the drum:

At a centrifugal clutch the drum is not fixed and will begin to turn when the engagement speed / operating speed is reached.

At a centrifugal brake the outer drum is fix and cannot turn. This causes a braking force when the friction pads touch the drum.

When designing and operating centrifugal brakes, there must be a special focus on braking time and maximum heat. Please refer to page 13 for further information.

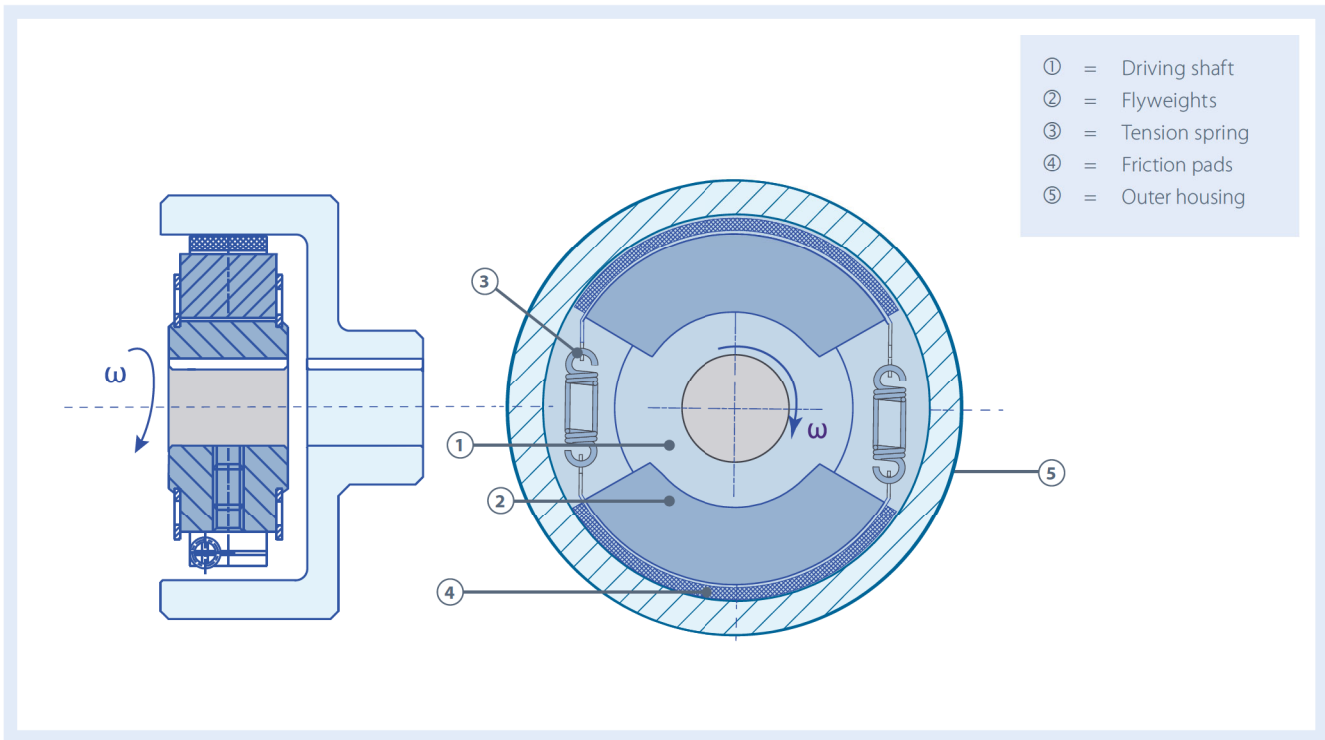

Construction of a centrifugal clutch /brake

Typical applications for centrifugal clutches:

Centrifugal clutches are mainly used as a start up clutch. A centrifugal clutch allows the usage of a smaller motor, because the motor can start loadfree until it has reached its optimum operating speed, at which the load is smoothly added by the centrifugal clutch.

Typical applications for centrifugal brakes:

The main application for centrifugal brakes is limiting the speed of e.g.

- descending weight or persons
- industrial applications (e. g. safety- and fire doors)
- leisure applications (e. g. Go Kart to a safe level)

What are the key criteria when selecting and designing a centrifugal clutch / brake:

Performance data:

- The power which needs to be transmitted (kW)
- Engagement speed [rpm]
- Operating speed [rpm]
- The max. allowable size

By knowing the max. size and power, the most suitable clutch model can be chosen, as all models do have a different performance factor

Additional required information for centrifugal brakes:

- Load in kg
- Max. braking time and braking frequency

Design and dimensions:

Input design:

- Shaft diameter

Output design:

There are different output designs possible. So we need to know if you use

- Only core version
- Flex coupling
- Belt Pulley design
- Ball bearings or not

Please refer to pages 14-15 for further information.

General technical information on centrifugal clutches and brakes

Calculating the torque:

M = torque [Nm]

n = speed of rotation [rpm]

P = power [kW or hp]

$$M = 9550 \cdot \frac{P}{n} \text{ [kW]}$$

$$M = 7121 \cdot \frac{P}{n} \text{ [hp]}$$

Criteria	F-Type	S-Type	W-Type	P-Type
Page	16	18	20	22
Compact design	●	●	○	
Noisefree operation		●	●	●
Easy replaceable parts	●		●	
Performance factor	2.5	1.5	1.0	1.75 - 1.25

Selection matrix of SUCO centrifugal clutches

Performance factor

The performance factor is a measure to compare the power transmission of clutches. The **W-Type** clutch has a performance factor of 1.0. The **F-Type** at the same size and the same flyweight mass can transmit 2.5x more torque.

Engagement speed:

The engagement speed of centrifugal clutches indicates the speed at which the centrifugal forces overcome the retaining forces of the spring and the friction pads touch the outer drum.

From the first engagement until the operating speed the friction pads will slip, what will cause wear of the pads.

To minimise wear of the friction pads, the target is to pass quickly through the engagement speed band to the operating speed.

General tolerance for engagement speed ± 100 rpm.

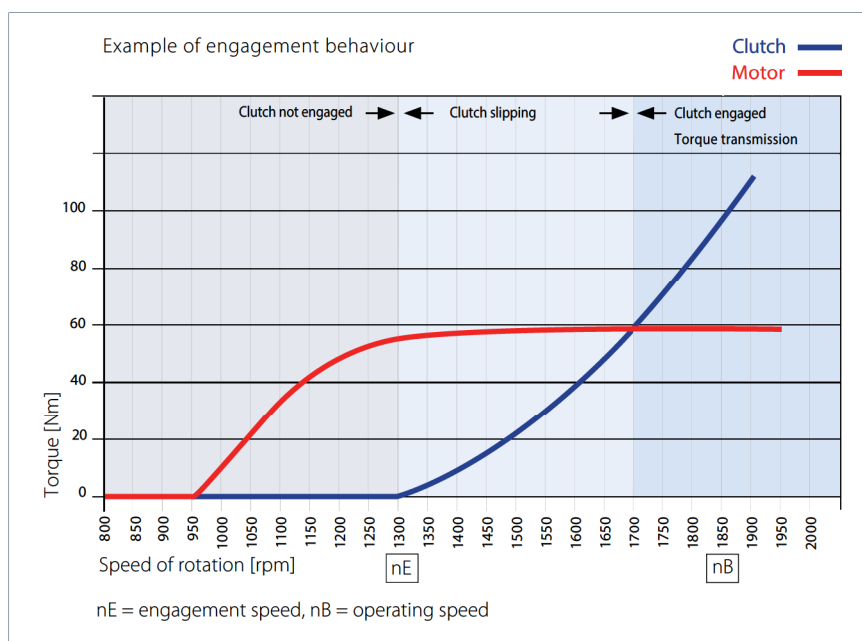

Operating speed:

At the operating speed the friction pads are in full contact with the drum and transfer the torque without slipping.

Variances in the motor speed must be considered when determining the operating speed. Therefore SUCO uses a safety factor which ensures a non-slipping application.

All SUCO clutches are dry-operated.

Centrifugal brakes:

Standard centrifugal brakes are used to limit speed – they cannot bring a system to standstill. The basic principle is to keep a balance between the load of the driving side and the braking torque. During the operation there is a constant friction which generates heat.

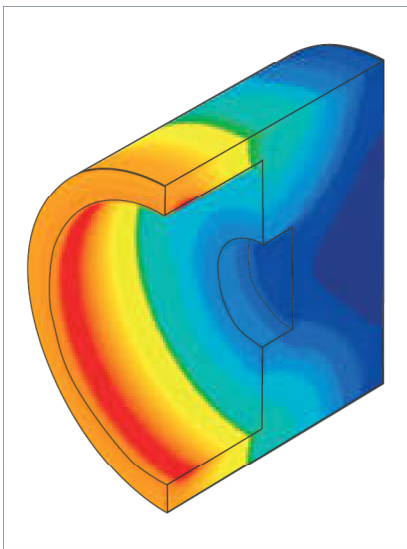

The amount of generated heat depends on various factors:

- Transmitted braking torque
- Brake speed
- Duration of the braking operation
- Size of the friction surface
- The mass of the brake drum that has to be heated

Over the braking time the temperature curve rises very steeply at the start and then gradually approaches a maximum. The temperature at the friction surface (T_2) is substantially higher than the temperature (T_1) at the outer surface of the brake drum.

Nevertheless, the brake drum can become very hot during operation and is a source of danger. The authority responsible for operation of the machine is solely responsible for ensuring that suitable protective measures are taken.

The maximum temperature must not exceed the manufacturer's maximum permitted temperature for the friction

material, otherwise the linings may be damaged. This can lead to a loss of effectiveness of the brake and, in the worst case, to destruction of the brake.

To prevent this, detailed data about the application is required when designing centrifugal brakes:

- Operating speed of the system to be braked
- Engagement speed of the centrifugal brake
- Braking torque required at the braking speed
- Changes in the braking torque
- Braking times and frequency
- Field of application

Centrifugal brakes are speed limiting devices and are finding increased use in lowering equipment. In such cases, the speed of lowering corresponds to the balanced condition between the speed governed by load torque and the speed governed by braking torque.

Friction produces heat

Centrifugal brakes convert mechanical energy into heat, which is generated between the linings and the brake drum, and mostly heats up the latter.

The temperature distribution illustrated above on a sectioned brake drum clearly shows the higher heating of the drum in the region over the flyweights.

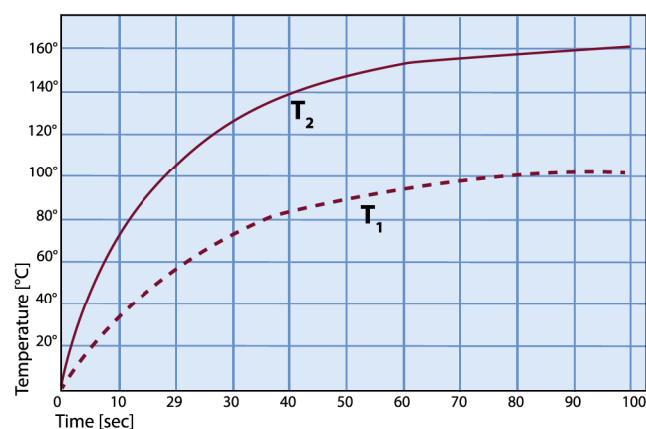

Different solutions, driven-side

To accommodate the variety of transmission requirements, SUCO offers a wide and flexible product range. Both axial and radial drives can be supplied.

All centrifugal brakes and clutches must only be used in conjunction with a suitable drum or belt pulley. The operation of a clutch or brake without a suitable drum or belt pulley is forbidden. Non-compliance can result in injury to persons.

Model K

Core version -K-

This version without a drum is supplied when a clutch or brake drum already exists in the customer's set up, or a suitable component for this purpose is available on the output side.

- The drum must be accurately centred and securely mounted.
- For higher torque transmission a clutch can be equipped with several rows of flyweights.
- The shaft diameter can be varied and tapered mountings are possible.

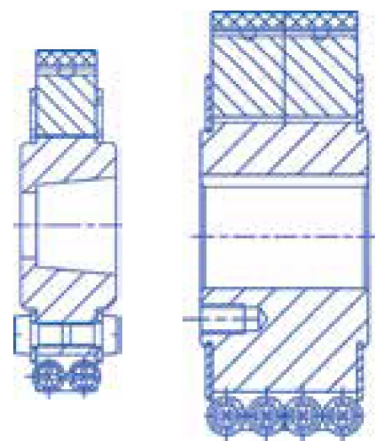

Figure 1

Figure 2

Model G

Core version with drum -G-

This version can be used to connect **two shaft ends**.

- The installation must have the lowest possible misalignment in both radial and angular directions.
- Excessive misalignment can result in rapid wear of the linings or complete failure of the clutch.

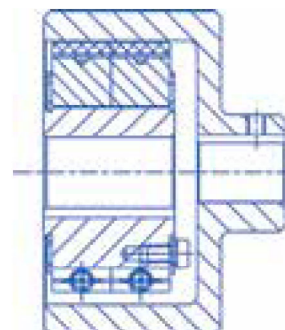

Figure 3

Model E

Unit version -E-

Where it is not practical to align both shaft ends or one shaft end and the drum, a bearing can be used between hub and drum.

As shown in Figure 4, the output drive can be directed through a tolerance ring on to which a belt pulley, a timing-belt pulley, or a mounting flange can be pressed.

Figure 5 shows a go kart clutch with a drive flange for a chain sprocket.

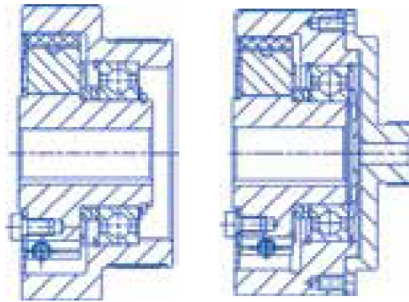

Figure 4

Figure 5

Unit version with flexible coupling -A-

The easiest way of compensating radial and angular misalignments between two shafts is to use a **flexible shaft coupling**.

The flexible coupling can be installed and located either radially or axially.

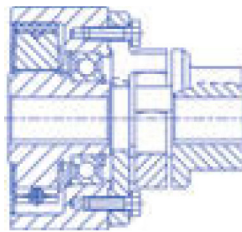

Figure 6

Model A

Belt-pulley version -R-

Where torque is transmitted through a **V-Belt**, the belt groove(s) can be machined in the drum. Single, duplex or multiple groove pulleys can be produced in this way.

Depending on the clutch size, effective pulley diameters from ca. **80 to 270 mm** can be incorporated.

Common groove forms are: **SPA, SPB, SPZ**, and **Poly-V according to DIN/EN**.

Figure 7 to 10 show different **belt-drive** clutch versions.

The clutch shown in Figure 9 with a split pulley allows **elimination of a tensioning pulley**. The V-Belt is tensioned by changing the spacer shims between the two pulley halves.

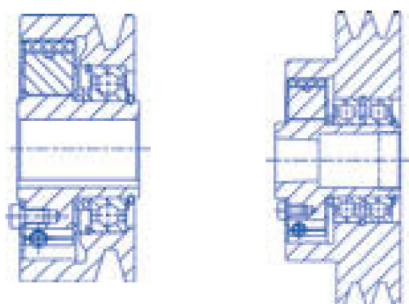

Figure 7

Figure 8

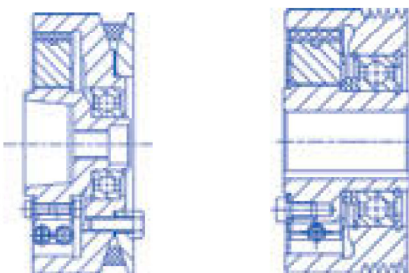

Figure 9

Figure 10

Model R

F-Type

Self-increasing clutch

Construction and mode of operation

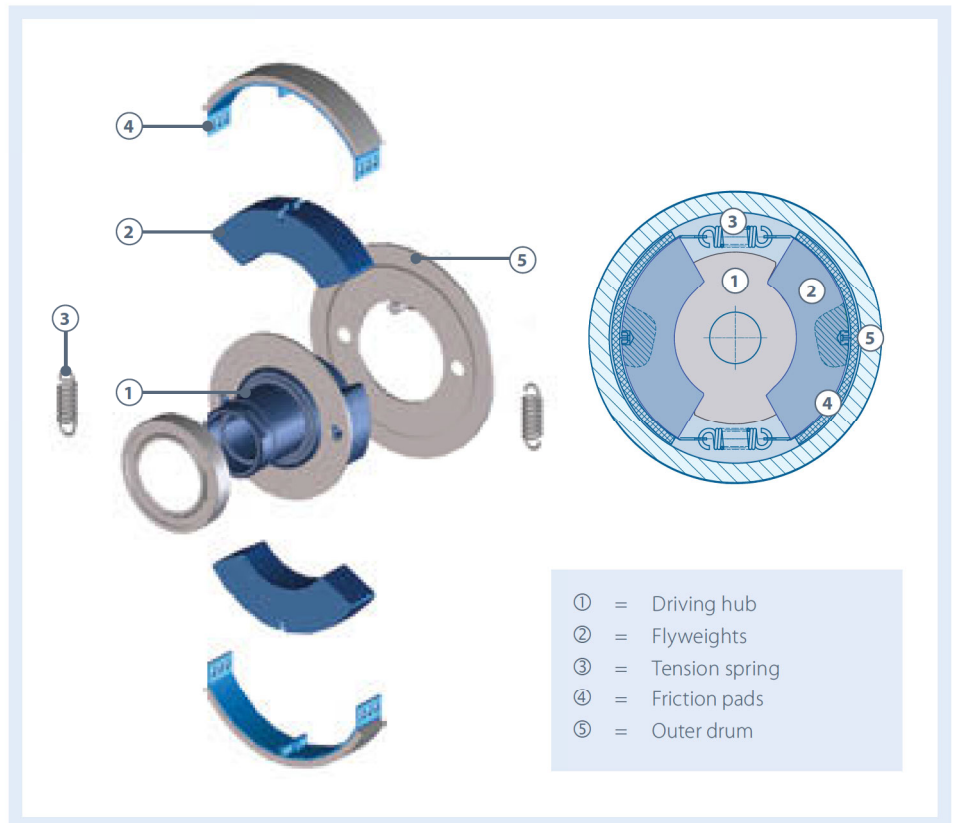

- High efficiency with a self-increasing effect
- Performance factor of 2.5
- Compact design
- Easy to service

F-Type

Performance data and dimensions

Type Number	D [mm]	B [mm] ¹	d max. [mm]	standard bore diameter d [mm] (inch) ²	Standard rotational speed					
					low		normal		high	
					Mat nE 750 and nB 1500 [Nm]	recommended motor power [kW] ³	Mat nE 1250 and nB 2500 [Nm]	recommended motor power [kW] ³	Mat nE 1500 and nB 3000 [Nm]	recommended motor power [kW] ³
F01	50	10	14	12			1.3	0.17	2	0.3
F02	60	15	18	15 (5/8)			4	0.5	5	0.8
F03	70	15	22	15; 20 (7/8)			7	0.9	10	1.6
F04	80	15	28	14 - 25 (3/4; 7/8)	4	0.3	11	1.4	16	2.5
F05	90	20	35	18; 20; 25 (3/4; 1)	10	0.8	26	3.4	40	6.3
F06	100	20	35	20; 24; 28 (3/4; 1)	16	1.3	42	5.5	60	9.4
F07	110	20	40	28; 35; 40 (1)	25	2.0	70	9.0	100	15.7
F08	125	20	50	25; 38; 49 (3/4; 1)	40	3.2	120	15.7	180	28.3
F09	138	25	55	30; 38; 48 (1)	90	7.0	240	31.0	320	50.0
F10	150	25	60	38; 48; 49	125	10.0	340	44.5	470	74.0
F11	165	30	65	42; 50; 55 (1 7/16)	220	17.2	620	81.0	870	136.0
F12	180	40	75	50; 60 (2 3/8)	460	36.0	1200	157.0	1700	267.0
F13	200	30	75	35; 55; 65 (2 3/8)	520	41.0	1300	170.0	1850	290.0

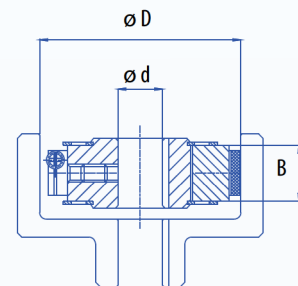

d = bore dia.
D = inside dia. of drum
B = flyweight width

d max. = max. bore dia.
M = torque
nE = engagement speed
nB = operating speed

¹⁾ The transmitted power increases as the width B is increased.
²⁾ Tapered bores and special dimensions can be manufactured on request.
³⁾ Motor power is calculated using a safety factor of 2.
Final selection of the clutch should be accomplished by SUCO!

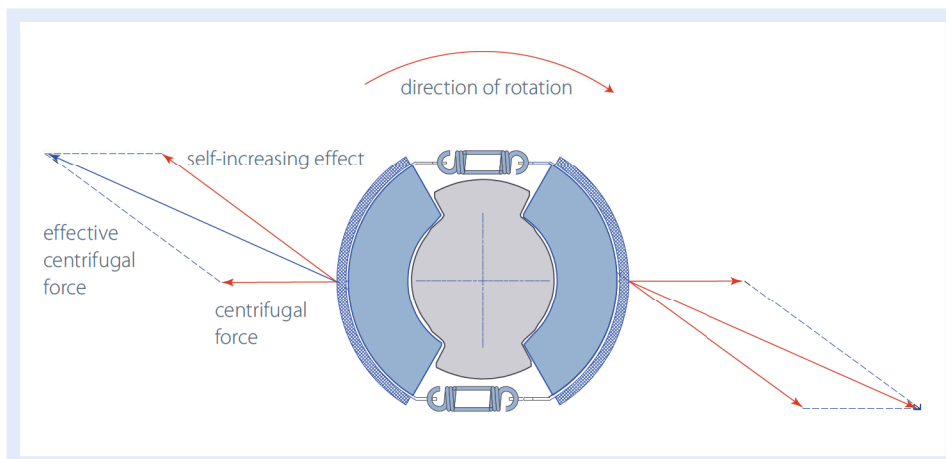

S-Type

Pin-guided clutch with three flyweights

Construction and mode of operation

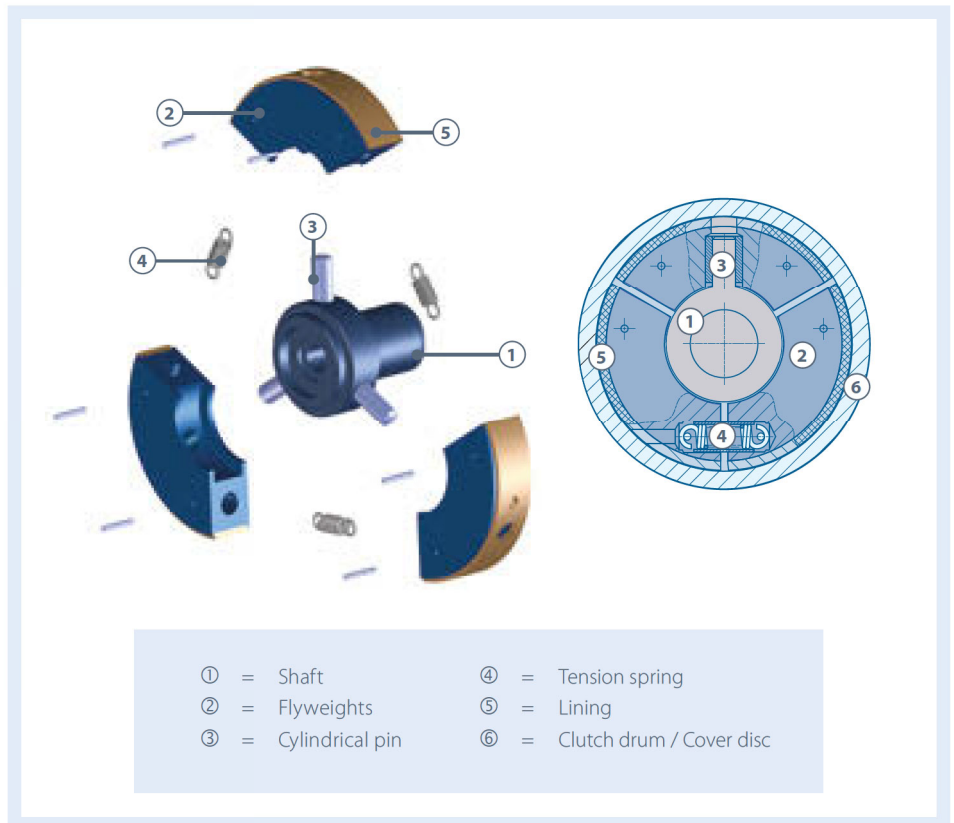

- Low noise level by guided pins
- Performance factor of 1.5
- Compact design

S-Type

Performance data and dimensions

Type Number	D [mm]	B [mm] ¹	d max. [mm]	standard bore diameter d [mm] (inch) ²	Standard rotational speed					
					low		normal		high	
					Mat nE 750 and nB 1500 [Nm]	recommended motor power [kW] ³	Mat nE 1250 and nB 2500 [Nm]	recommended motor power [kW] ³	Mat nE 1500 and nB 3000 [Nm]	recommended motor power [kW] ³
S04	80	25	24	15 (3/4; 7/8)	4.3	0.3	12	1.6	17.5	2.8
S05	90	25	30	14; 30 (3/4; 1)	7.5	0.6	212	2.8	31	4.9
S06	100	25	24	20; 24; 28 (3/4; 7/8)	11	0.8	30	4.0	43	7.0
S07	110	25	30	28; 30 (1)	15	1.2	45	6.0	64	10.0
S08	125	25	40	20; 30 (1; 1/2)	30	2.4	85	11.0	124	20.0
S09	138	25	30	17; 30 (1; 1 1/8)	40	3.0	112	15.0	160	25.0
S10	150	35	40	38; (1 1/8)	78	6.0	216	28.0	310	49.0

d max. = max. bore dia.
M = torque
nE = engagement speed
nB = operating speed

¹⁾ The transmitted power increases as the width B is increased.
²⁾ Tapered bores and special dimensions can be manufactured on request.
³⁾ Motor power is calculated using a safety factor of 2.
Final selection of the clutch should be accomplished by SUCO!

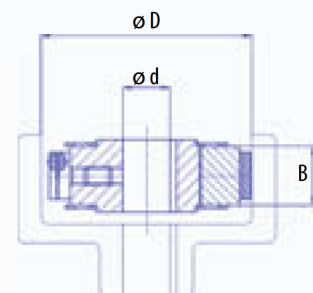

d = bore dia.
D = inside dia. of drum
B = flyweight width

W-Type

Pin-guided clutch with two flyweights

Construction and mode of operation

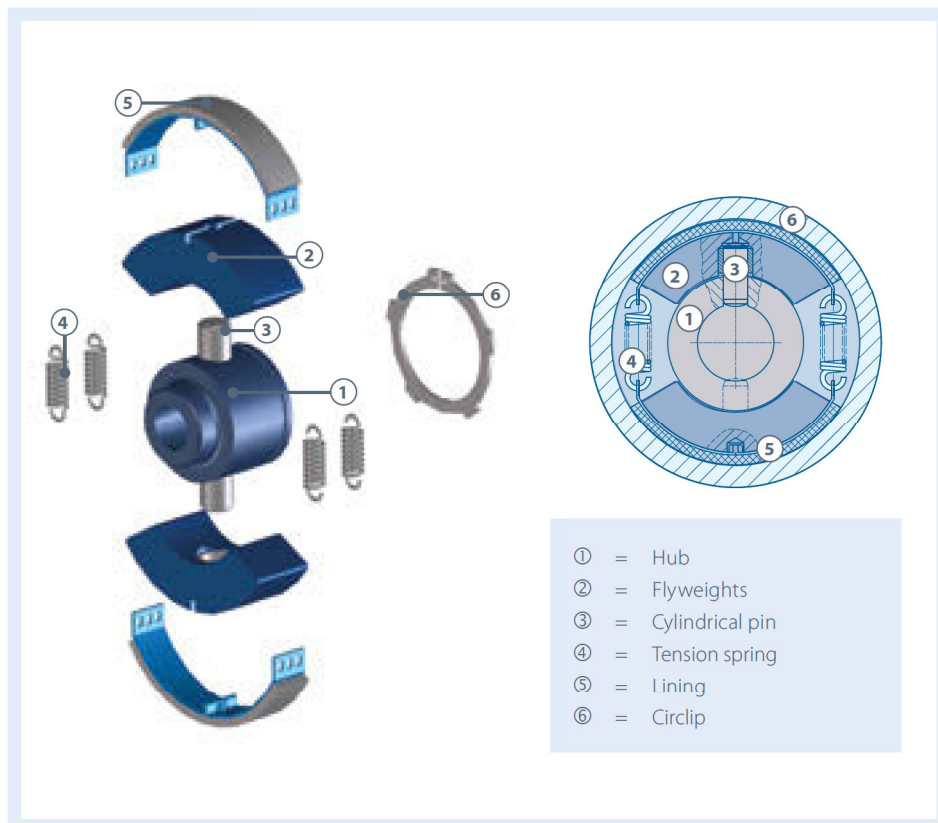
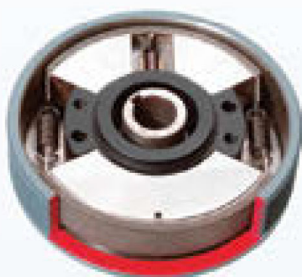

- Low noise level by guided pins
- Easy to service
- Performance factor 1.0

W-Type

Performance data and dimensions

Type Number	D [mm]	B [mm] ¹	d max. [mm]	standard bore diameter d [mm] (inch) ²	Standard rotational speed					
					low		normal		high	
					Mat nE 750 and nB 1500 [Nm]	recommended motor power [kW] ³	Mat nE 1250 and nB 2500 [Nm]	recommended motor power [kW] ³	Mat nE 1500 and nB 3000 [Nm]	recommended motor power [kW] ³
W04	80	15	15	15	1.7	0.14	4.6	0.6	6.6	1.0
W05	90	20	25	14 (5/8)	3.7	0.3	10.3	1.4	14.8	2.3
W06	100	20	30	30	5.7	0.45	16.0	2.0	23.0	3.6
W07	110	20	40	-	8.6	0.7	24.0	3.2	34.5	5.5
W08	125	20	40	20; 30 (1 1/2)	14.0	1.0	38.5	5.0	55	8.5
W09	138	25	55	-	27.0	2.2	75.0	9.8	110	17
W10	150	25	60	38 (1 1/8)	36.5	3.0	102	13	145	23

d max. = max. bore dia.
M = torque
nE = engagement speed
nB = operating speed

¹⁾ The transmitted power increases as the width B is increased.
²⁾ Tapered bores and special dimensions can be manufactured on request.
³⁾ Motor power is calculated using a safety factor of 2.
Final selection of the clutch should be accomplished by SUCO!

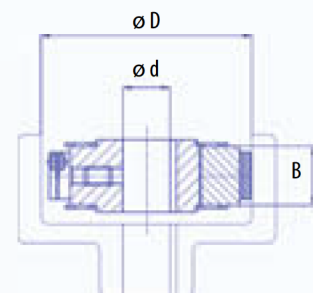

d = bore dia.
D = inside dia. of drum
B = flyweight width

Construction and mode of operation

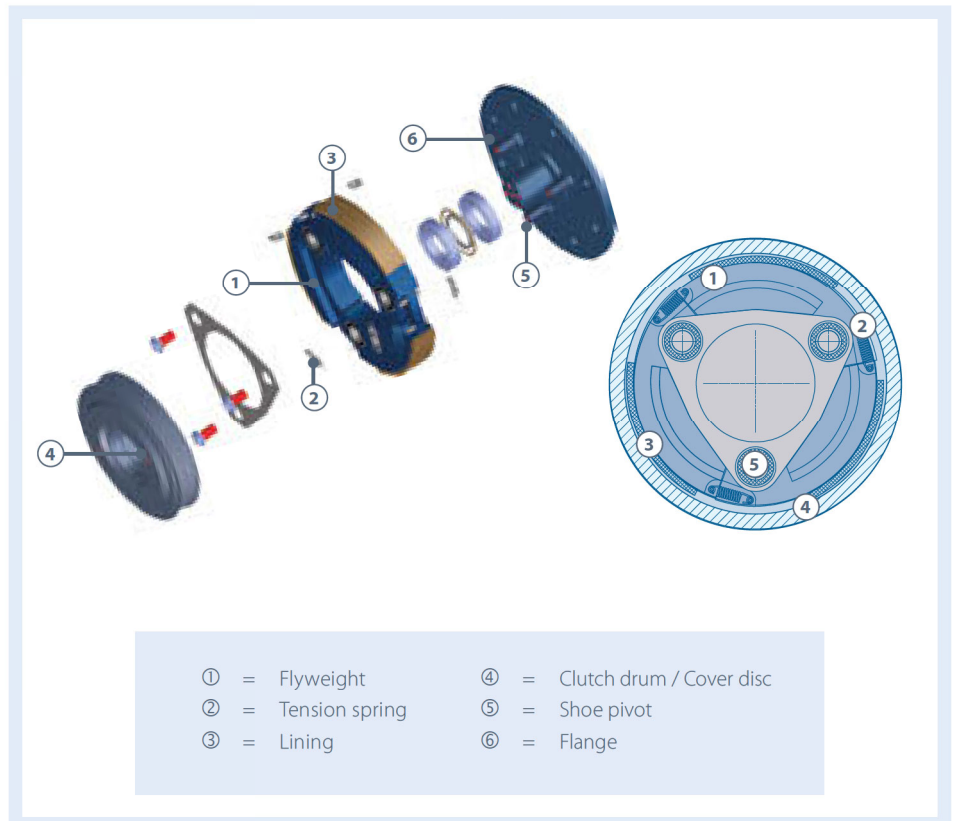
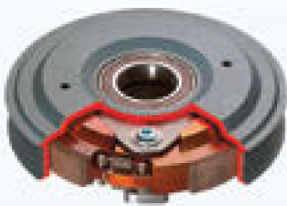

- Extremely narrow design
- Lowest noise level of SUCO clutches
- Performance factor between 1.75 and 1.25 (depending on direction of rotation)

P-Type

Performance data and dimensions

Type Number	D [mm]	B [mm] ¹⁾	Standard rotational speed			
			low		high	
			Mat.nE 750 and nB 1500 [Rpm]	recommended motor power [kW] ²⁾	Mat.nE 1500 and nB 3000 [Rpm]	recommended motor power [kW] ²⁾
P11	187	30	175	13	460	60
P12	193	30	180	14	500	70

Other sizes are available on request.

- M = torque
nE = engagement speed
nB = operating speed
- ¹⁾ The transmitted power increases as the width B is increased.
²⁾ Motor power is calculated using a safety factor of 2.
Final selection of the clutch should be accomplished by SUCO!

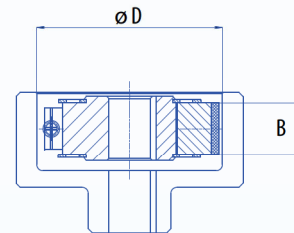

D = inside dia. of drum

B = flyweight width

Key to model codes

