

Spannsätze

RINGFEDER® RfN 7006

Montage, Demontage, erneute Montage

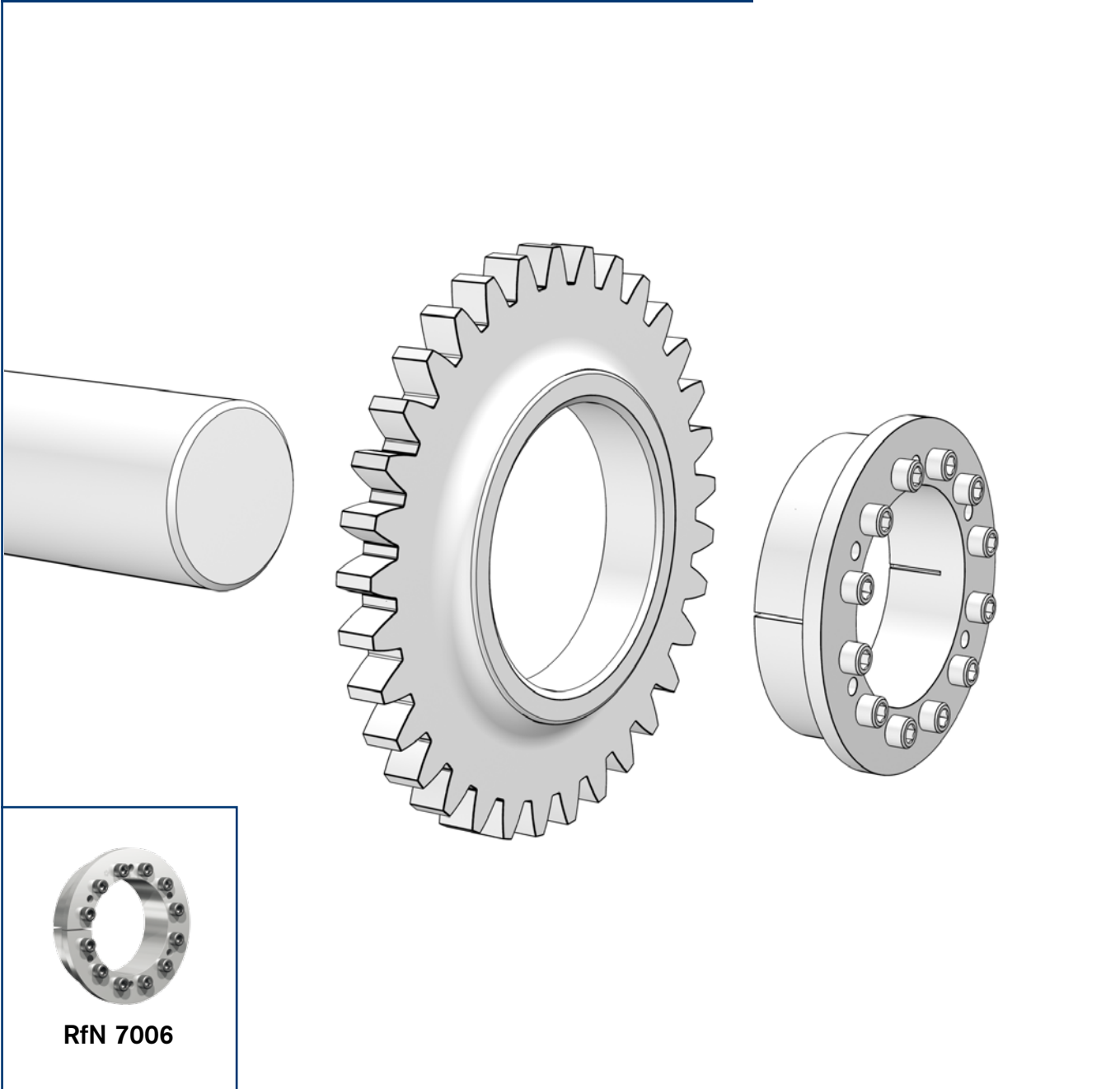

RfN 7006

Sicherheitshinweise

Rotierende Maschinenteile können Bediener und Servicepersonal verletzen! Deshalb:

- Schalten Sie vor Montagearbeiten den Antrieb ab.
- Sichern Sie die Maschine gegen unbeabsichtigtes Einschalten.
- Montieren Sie vor Einschalten der Maschine alle Abdeckungen und Schutzeinrichtungen.
- Die Montage von RINGFEDER® Produkten darf nur durch fachkundiges Personal und für geeignete Anwendungsfälle erfolgen.

Achtung

- Diese Anleitung bitte gründlich durchlesen.
- Bei Zuwiderhandlung gegen die Hinweise in dieser Anleitung besteht kein Haftungsanspruch.
- RINGFEDER POWER TRANSMISSION behält sich technische Änderungen zur Produktverbesserung vor.
- RINGFEDER® Spannsätze entsprechen dem anerkannten Stand der Technik.

Bei Problemen oder Rückfragen stehen Ihnen unsere Mitarbeiterinnen und Mitarbeiter aus Technik und Service gerne zur Verfügung. Die entsprechenden Kontaktinformationen finden Sie auf der Rückseite dieser Anleitung.

Verwendete Schmiermittel

Bezeichnung

Maschinenöl Shell Omala 220 oder vergleichbares

Legende



Montage



Demontage



Erneute Montage



Reinigen



Nabe und Welle gegebenenfalls leicht einölen (keine MoS2-haltigen Öle verwenden).

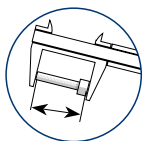

Schraube auf Verformung prüfen und gegebenenfalls austauschen.



Beschriebenen Vorgang über Kreuz in so vielen Durchgängen wie angegeben ausführen.



Beschriebenen Vorgang in so vielen Durchgängen wie angegeben ausführen.



Auf zulässige Rauhtiefe prüfen.



Achtung! Unbedingt beachten!



Gültige Daten über die erforderlichen Anzugsmomente können dem Product Paper & Tech Paper „Spannsätze“ sowie unserer Webseite entnommen werden. Bitte prüfen Sie, ob der Maschinen-/Anlagenbauer abweichende Anzugsmomente vorgegeben hat.

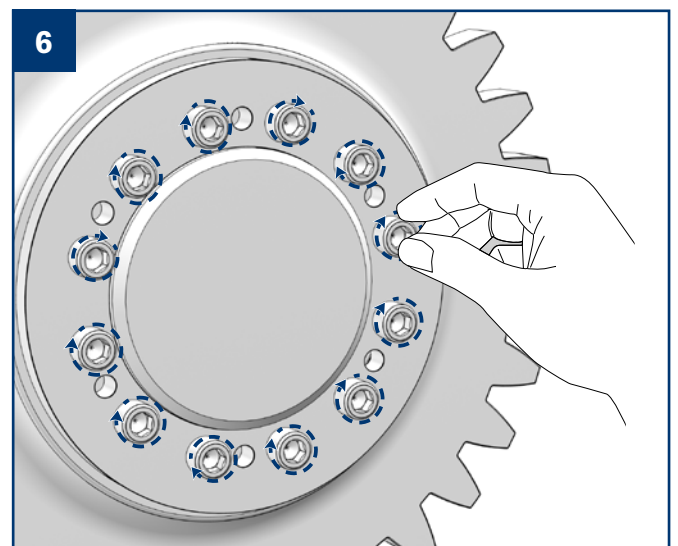
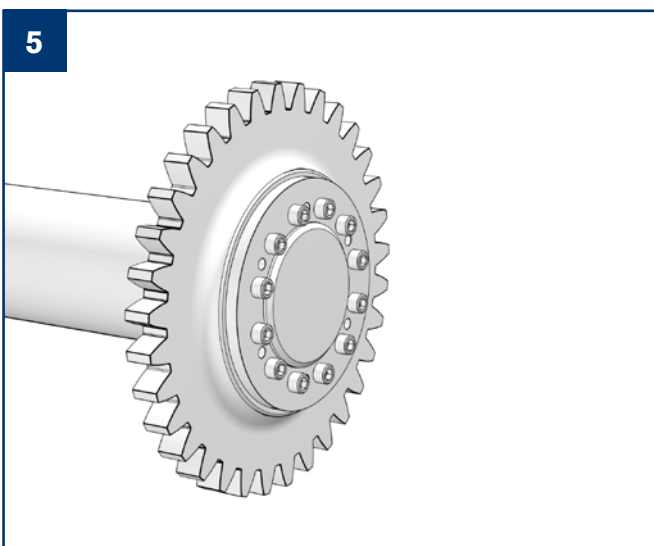
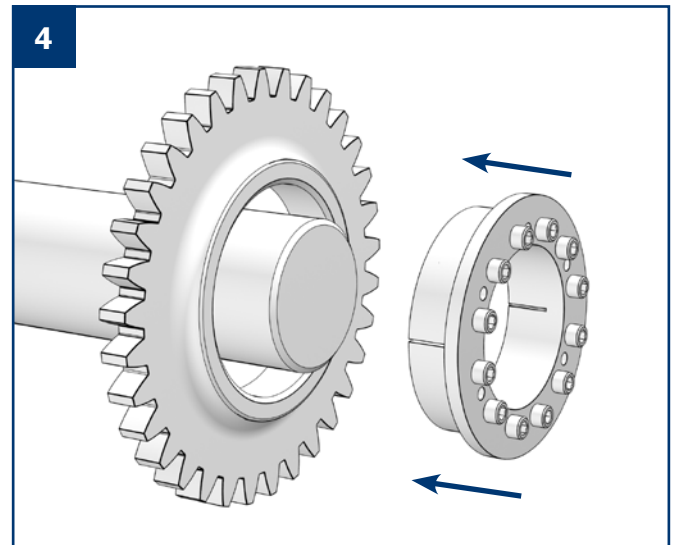
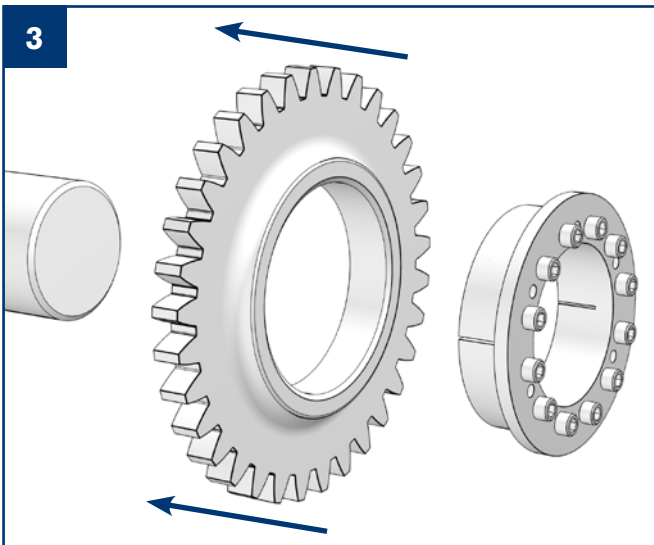
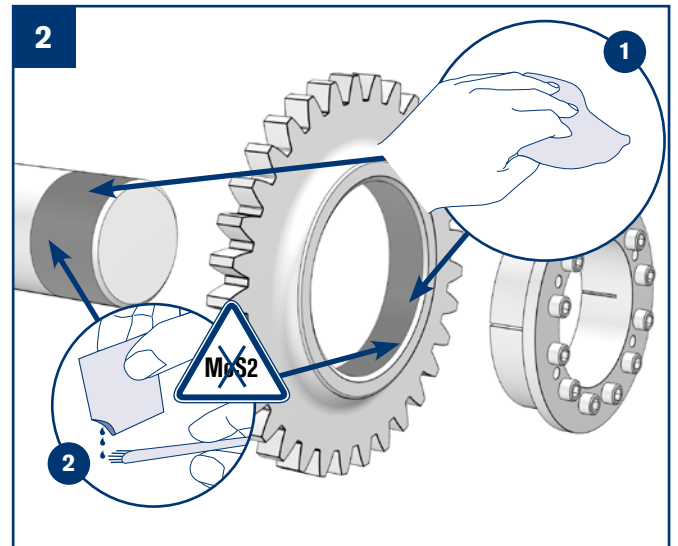
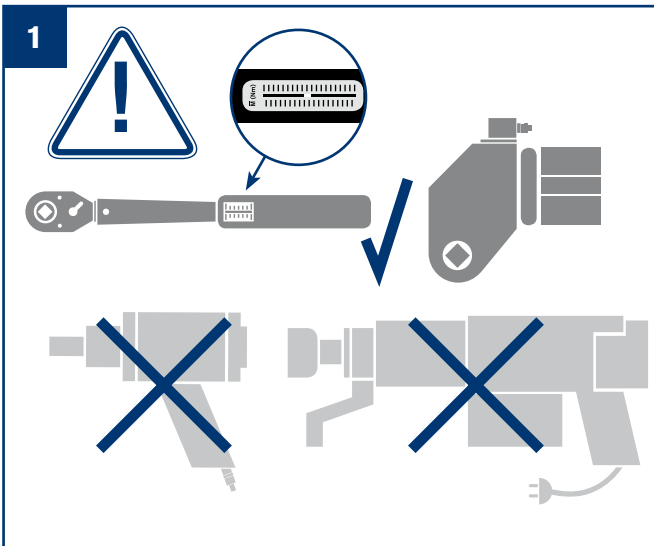

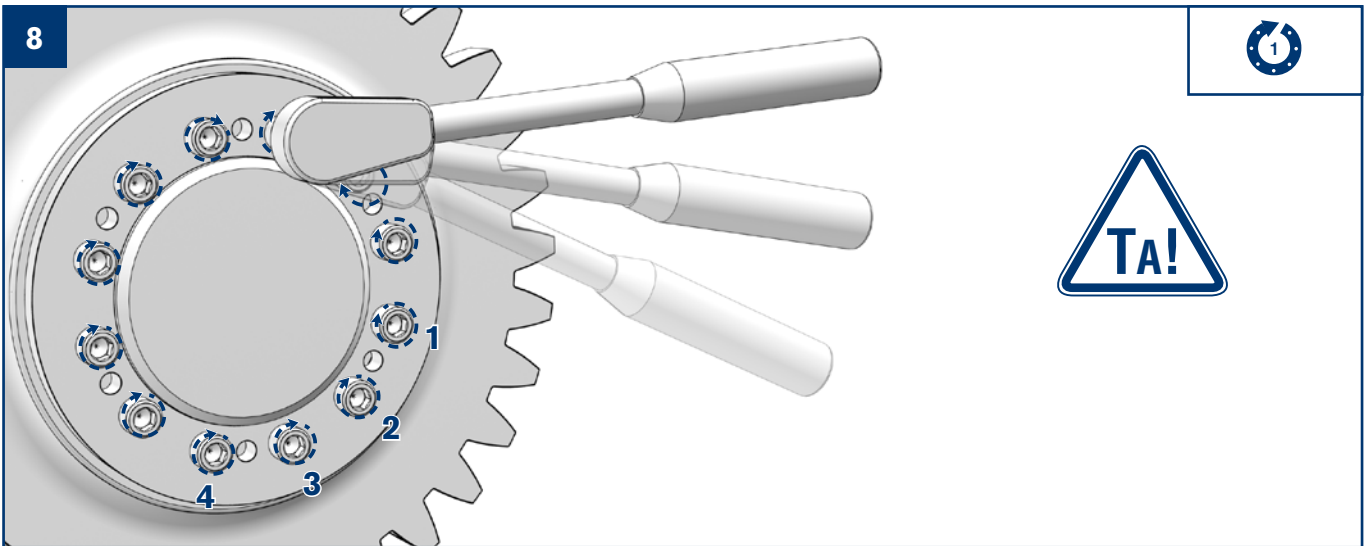
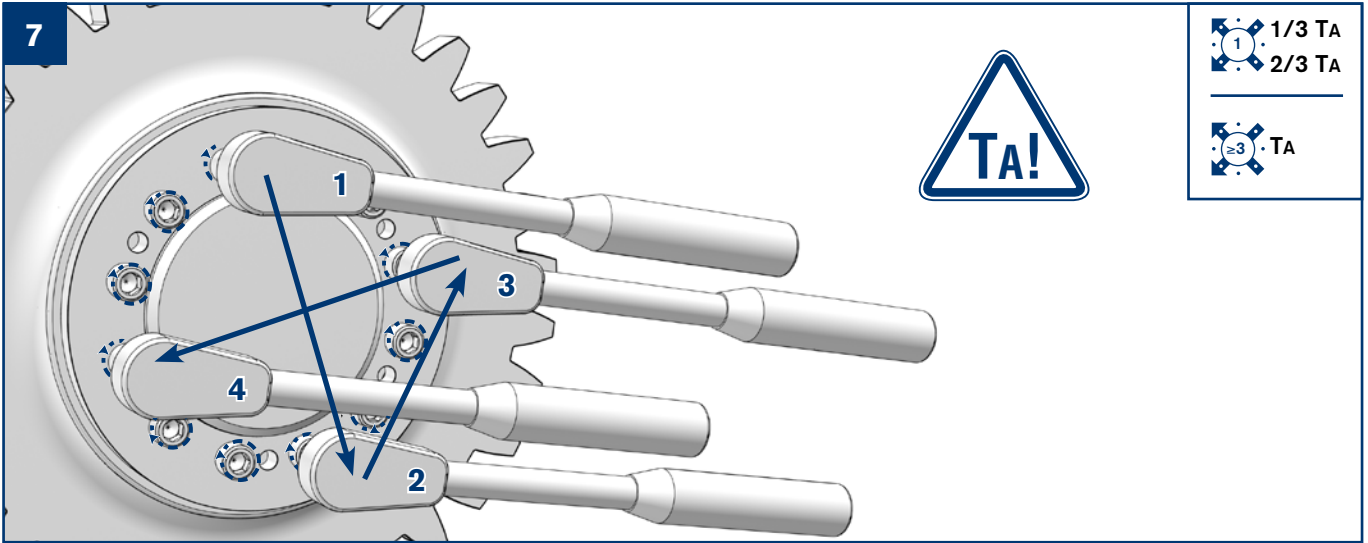

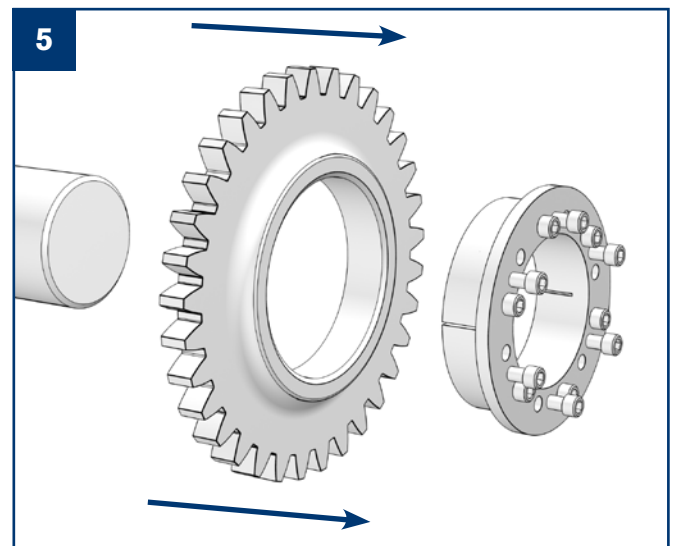
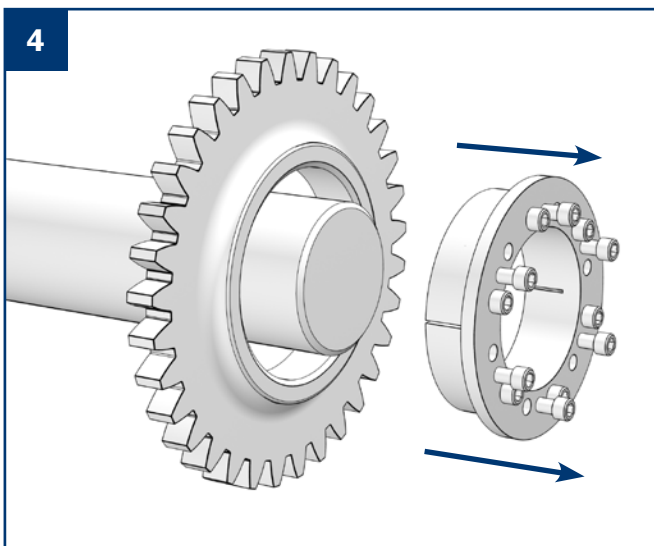
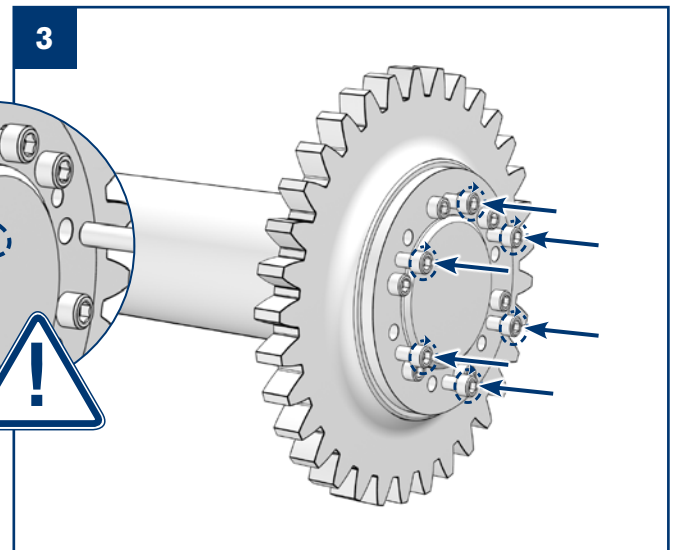
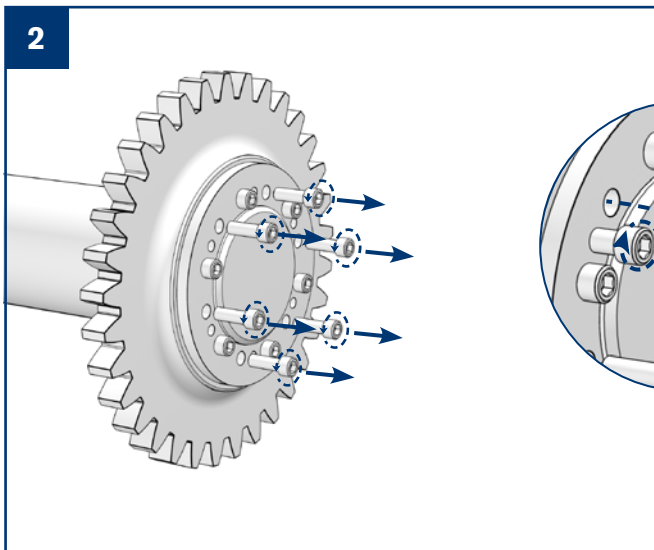
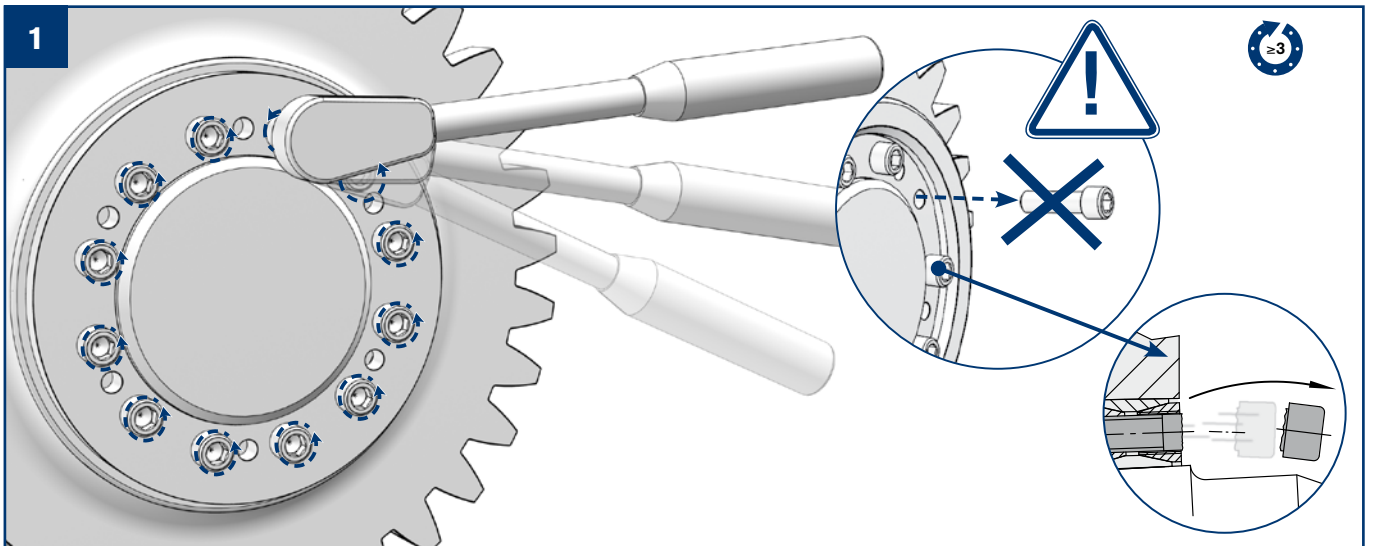

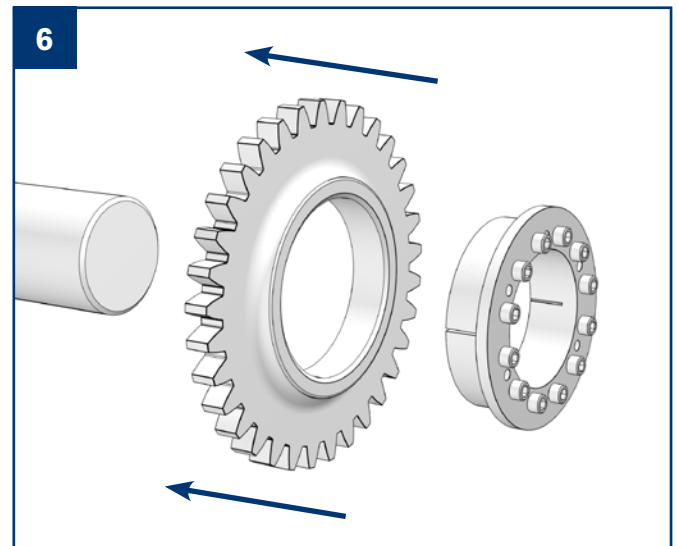
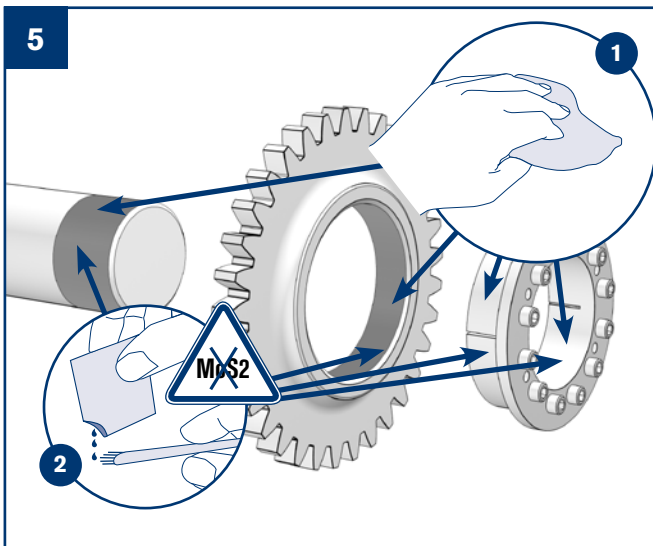
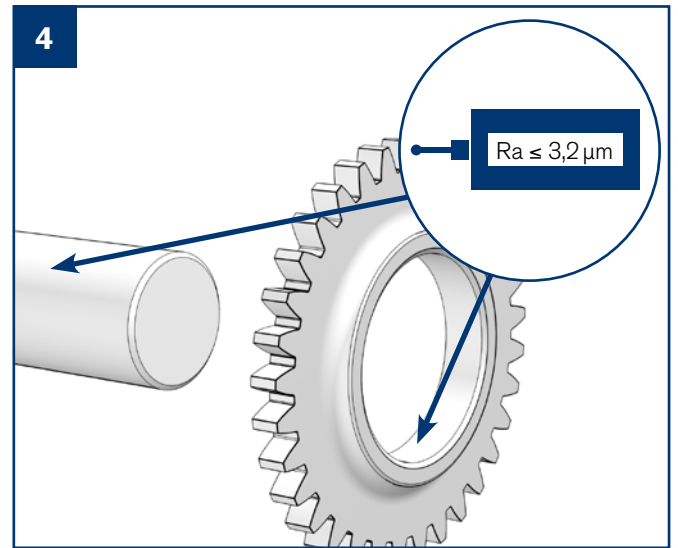
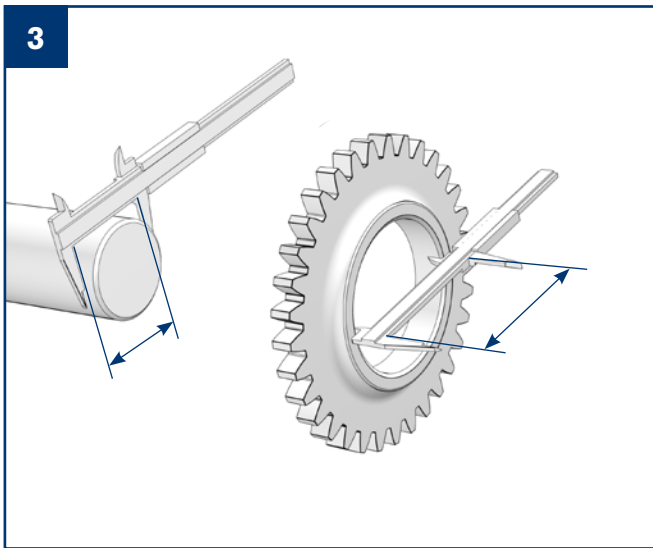
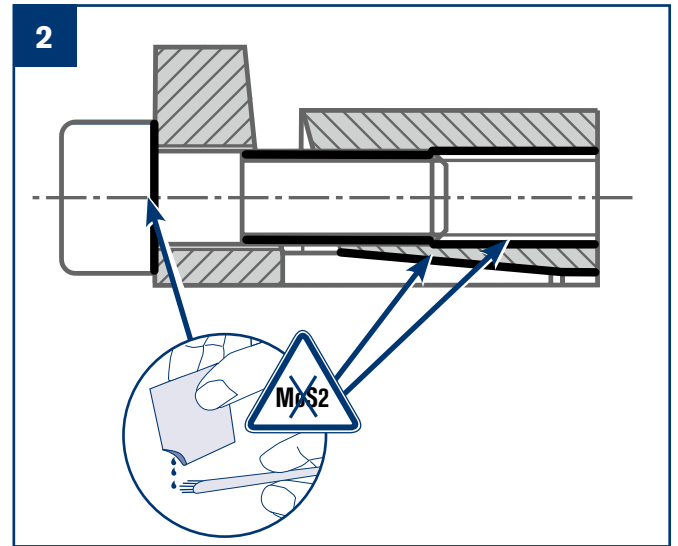
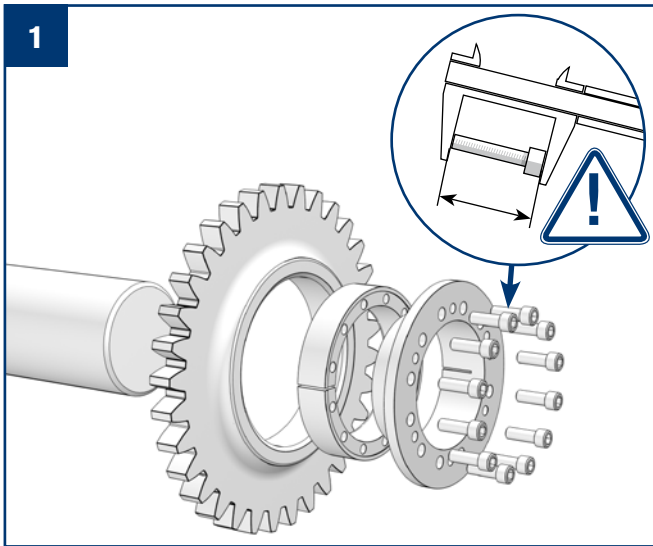

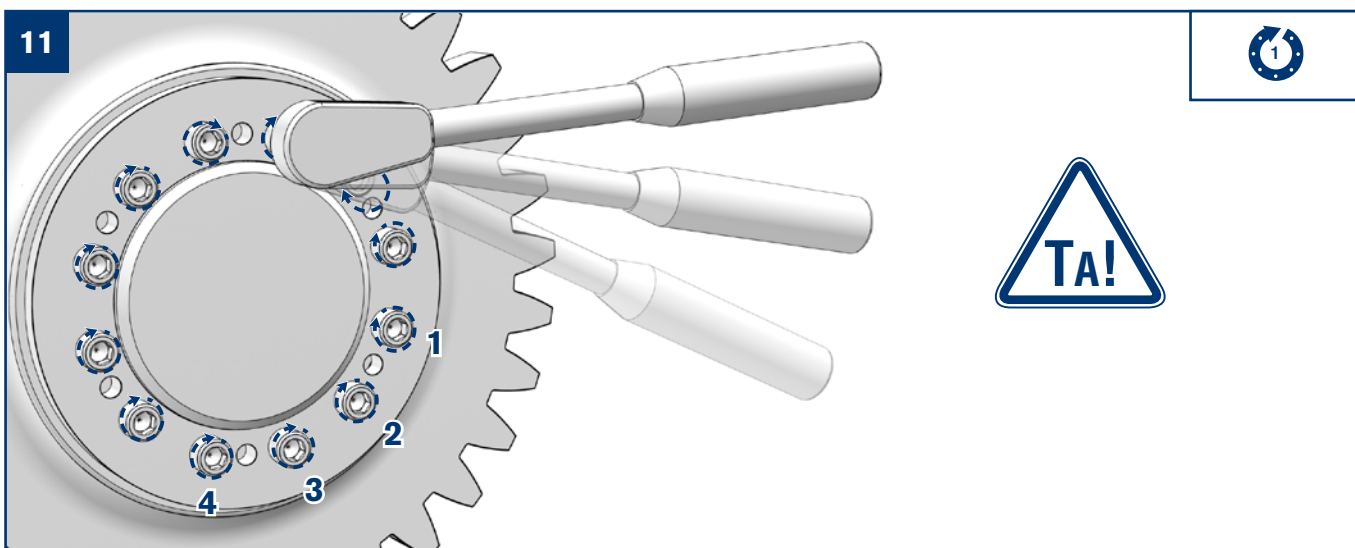
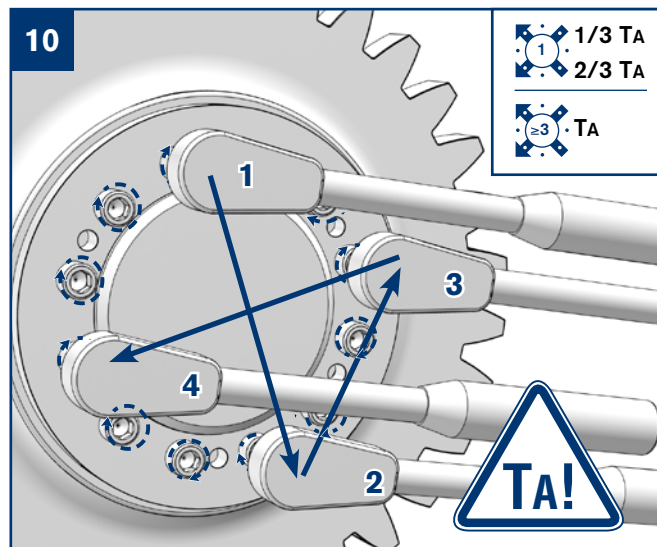
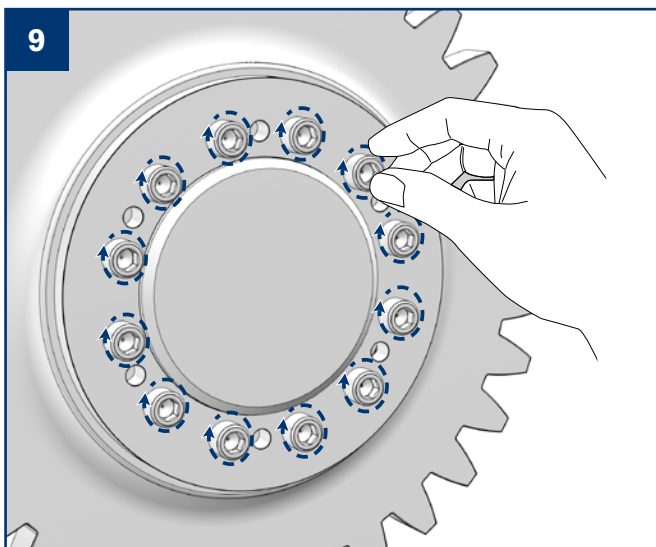
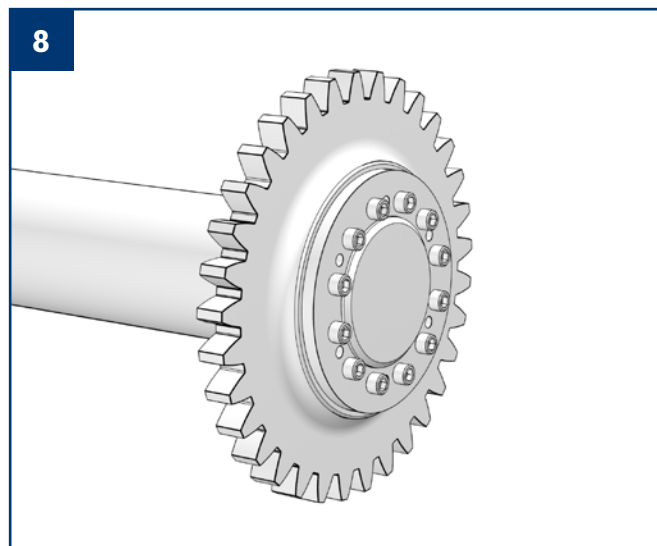
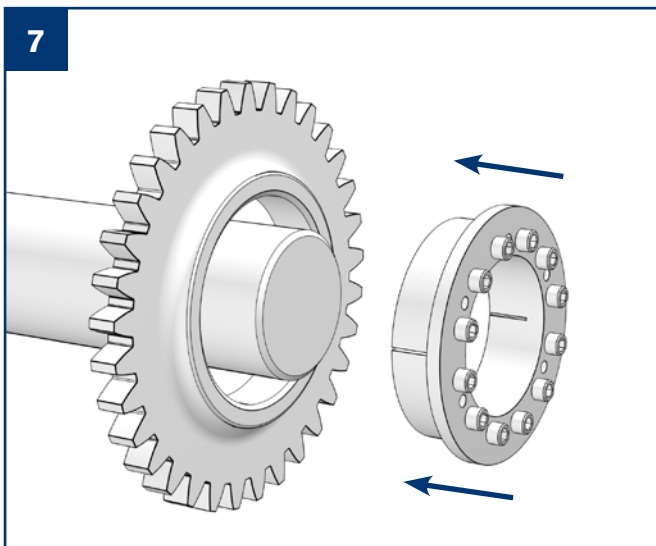

RINGFEDER POWER TRANSMISSION GMBH

Werner-Heisenberg-Straße 18, D-64823 Groß-Umstadt, Germany · Phone: +49 (0) 6078 9385-0 · Fax: +49 (0) 6078 9385-100
E-mail: sales.international@ringfeder.com

RINGFEDER POWER TRANSMISSION TSCHAN GMBH

Zweibrücker Straße 104, D-66538 Neunkirchen, Germany · Phone: +49 (0) 6821 866-0 · Fax: +49 (0) 6821 866-4111
E-mail: sales.tschan@ringfeder.com

RINGFEDER POWER TRANSMISSION USA CORPORATION

165 Carver Avenue, Westwood, NJ 07675, USA · Toll Free: +1 888 746-4333 · Phone: +1 201 666 3320 · Fax: +1 201 664 6053
E-mail: sales.usa@ringfeder.com

HENFEL INDÚSTRIA METALÚRGICA LTDA.

Av. Major Hilário Tavares Pinheiro, 3447 · CEP 14871 300 · Jaboticabal - SP - Brazil · Phone: +55 (16) 3209-3422
E-mail: vendas@henfel.com.br

RINGFEDER POWER TRANSMISSION INDIA PRIVATE LIMITED

Plot No. 4, Door No. 220, Mount - Poonamallee Road, Kattupakkam, Chennai – 600 056, India
Phone: +91 (0) 44-2679 1411 · Fax: +91 (0) 44-2679 1422 · E-mail: sales.india@ringfeder.com

KUNSHAN RINGFEDER POWER TRANSMISSION COMPANY LIMITED

NO. 406 Jiande Road, Zhangpu 215321, Kunshan, Jiangsu Province, China
Phone: +86 (0) 512-5745-3960 · Fax: +86 (0) 512-5745-3961 · E-mail: sales.china@ringfeder.com

Partner for Performance
www.ringfeder.com

