

LCM
 LCR
 LCG
 LCW
 LCX
 STM
 STG
 STS/STL
 STR2
 UCA2
 ULK*
 JSK/M2
 JSG
 JSC3/JSC4
 USSD
 UFCD
 USC
 UB
 JSB3
 LMB
 LML
 HCM
 HCA
 LBC
 CAC4
 UCAC2
 CAC-N
 UCAC-N
 RCS2
 RCC2
 PCC
 SHC
 MCP
 GLC
 MFC
 BBS
 RRC
 GRC
 RV3*
 NHS
 HRL
 LN
Hand
 Chuk
 MecHnd/Chuk
 ShkAbs
 FJ
 FK
 SpdContr
 Ending
 LSH-HP
 LSH
 FH100
 BSA2
 BHA/BHG
 LHA
 LHAG
 HAP
 HKP
 HCP
 HGP
 HLF2
 HLA/HLB
 HLAG/HLBG
 HLC
 HLD
 HMF
 HMF-G
 HMF-B
HFP
 FH500
 HBL
 HJL
 HMD
 HDL
 HJD
 BHE

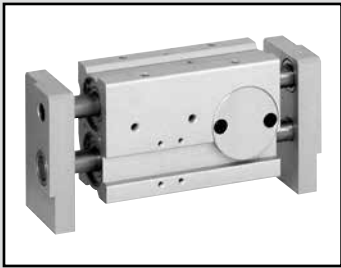

Wide parallel hand Double acting

HFP Series

● Operating stroke length: 20, 30, 40, 60 mm
Double acting



Specifications

Item	HFP				
	2CS	3CS	4CS	5CS	
Size					
Bore size	mm	ø16×2	ø25×2	ø32×2	ø40×2
Actuation	Double acting				
Working fluid	Compressed air				
Max. working pressure	MPa	0.7 (≈100 psi, 7 bar)			
Min. working pressure	MPa	0.3 (≈44 psi, 3 bar)			
Ambient temperature	°C	5 (41°F) to 60 (140°F)			
Port size		M5		Rc1/8	
Operating stroke length	mm	20	30	40	60
Rod diameter	mm	ø10	ø12	ø15	ø18
Volumetric capacity (reciprocating)	cm ³	4.90	22.70	50.2	120.3
Repeatability	mm	±0.03			
Weight	kg	0.59	1.10	2.07	3.90
Lubrication		Not required (use turbine oil class 1 ISO VG32 if necessary for lubrication)			

Switch specifications

Item	Proximity 2-wire	Proximity 3-wire
	T2H/V	T3H/V
Applications	Dedicated for programmable controller	For programmable controller, relay
Output method	-	NPN output
Power supply voltage	-	10 to 28 VDC
Load voltage/current	10 to 30 VDC, 5 to 20 mA (*1)	30 VDC or less, 100 mA or less
Indicator lamp	LED (Lit when ON)	
Leakage current	1 mA or less	10 µA or less
Weight	1 m:18 g 3 m:49 g 5 m:80 g *3	

*1 : The above max. load current is 20 mA at 25°C.

The current is lower than 20 mA if the operating ambient temperature around the switch is higher than 25°C. (5 to 10 mA at 60°C)

*2 : Refer to Ending Page 1 for detailed switch specifications and dimensions.

*3 : The weight of switch mounting bracket is 1.5 g.

How to order

Without switch (built-in magnet for switch)

HFP - 2CS

With switch (built-in magnet for switch)

HFP - 2CS - T2H - R

A Size

B Switch model No.

C Switch quantity

[Example of model No.]

HFP-2CS-T2H-R

Model: Wide parallel hand

- A** Size : 2CS
- B** Switch model No. : Proximity T2H switch, lead wire 1 m
- C** Switch quantity : 1 on open side

Code	Description
A Size	
2CS	
3CS	
4CS	
5CS	
B Switch model No.	
Axial lead wire	Radial lead wire
T2H*	T2V*
T3H*	T3V*
Contact	Voltage
	AC DC
	Display
	Lead wire
	1-color 2-wire
	display 3-wire
* Lead wire length	
Blank	1 m (standard)
3	3 m (option)
5	5 m (option)
C Switch quantity	
R	1 on open side
H	1 on closed side
D	2

How to order switch

- For switch T*H*
 - Switch body + mounting bracket set

HFP - T2H

Switch model No.
(Item B above)

- Switch body

SW - T2H

Switch model No.
(Item B above)

- Mounting bracket set

HFP - T

- For switch T*V*
 - Switch body + mounting bracket set

HFP - T2V - *

Switch model No.
(Item B above)

- Switch body

SW - T2V

Switch model No.
(Item B above)

- Mounting bracket set

HFP - TV - *

(Select either R (open side) or H (closed side) for sections marked with an asterisk (*).)

LCM
LCR
LCG
LCW
LCX
STM
STG
STS/STL
STR2
UCA2
ULK*
JSK/M2
JSG
JSC3/JSC4
USSD
UFCD
USC
UB
JSB3
LMB
LML
HCM
HCA
LBC
CAC4
UCAC2
CAC-N
UCAC-N
RCS2
RCC2
PCC
SHC
MCP
GLC
MFC
BBS
RRC
GRC
RV3*
NHS
HRL
LN
Hand
Chuk
MechHnd/Chuk
ShkAbs
FJ
FK
SpdContr
Ending
LSH-HP
LSH
FH100
BSA2
BHA/BHG
LHA
LHAG
HAP
HKP
HCP
HGP
HLF2
HLA/HLB
HLAG/HLBG
HLC
HLD
HMF
HMF-G
HMFB
HFP
FH500
HBL
HJL
HMD
HDL
HJD
BHE

Internal structure and parts list

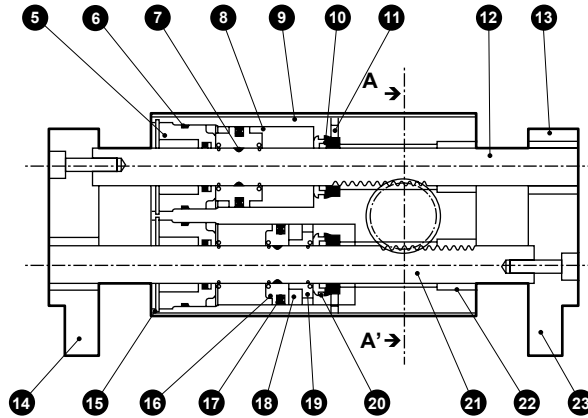
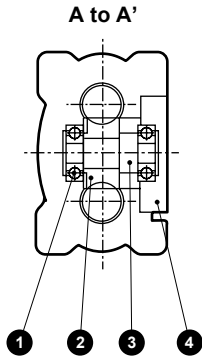

Cannot be disassembled

No.	Part name	Material	Remarks	No.	Part name	Material	Remarks
1	Bearing	Alloy steel		13	Bush	Copper alloy casting	
2	Pinion gear	Steel		14	Finger A	Aluminum alloy	
3	Pinion gear shaft	Steel		15	Snap ring	Stainless steel	
4	Bearing cover	Aluminum alloy		16	Piston A	Aluminum alloy	
5	Packing seal housing A	Aluminum alloy		17	Piston packing	Nitrile rubber	
6	Gasket A	Nitrile rubber		18	Magnet	Plastic magnet	
7	Piston gasket	Nitrile rubber		19	Piston B	Aluminum alloy	
8	Piston fixing spring	Stainless steel		20	Gasket B	Nitrile rubber	
9	Body	Aluminum alloy		21	Piston rod B	Stainless steel	
10	Rod packing	Nitrile rubber		22	Bush	Copper alloy casting	
11	Packing seal housing B	Aluminum alloy		23	Finger B	Aluminum alloy	
12	Piston rod A	Stainless steel					

Gripping power performance data

- Gripping power represents the thrust (per one finger) in the arrow direction shown in the figure.
- The gripping power in the opening/closing directions with finger length L of hand with a supply pressure of 0.3, 0.5 and 0.7 MPa is shown.
- Both open direction (◀) and closed direction (▶) (shown with continuous line)

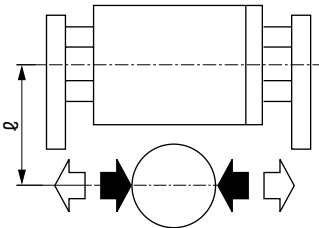

(Note) When making a selection, read the precautions for design and selection on page 1764.

● HFP-2CS

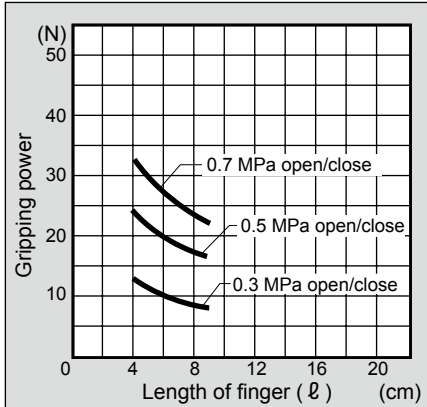

● HFP-3CS

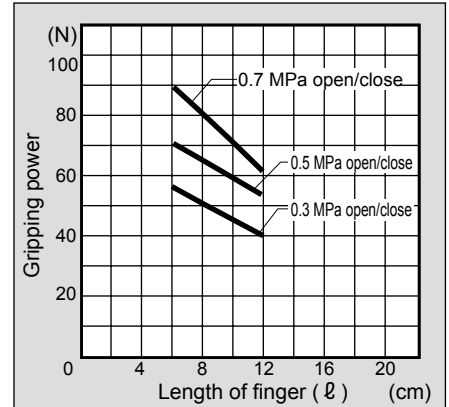

● HFP-4CS

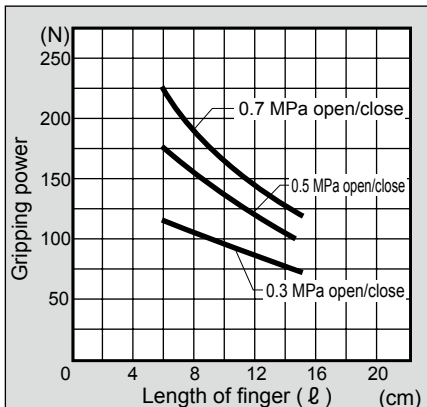

● HFP-5CS

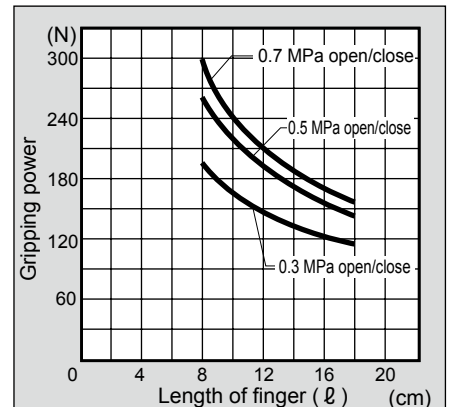

- LCM
- LCR
- LCG
- LCW
- LCX
- STM
- STG
- STS/STL
- STR2
- UCA2
- ULK*
- JSK/M2
- JSG
- JSC3/JSC4
- USSD
- UFCD
- USC
- UB
- JSB3
- LMB
- LML
- HCM
- HCA
- LBC
- CAC4
- UCAC2
- CAC-N
- UCAC-N
- RCS2
- RCC2
- PCC
- SHC
- MCP
- GLC
- MFC
- BBS
- RRC
- GRC
- RV3*
- NHS
- HRL
- LN
- Hand
- Chuk
- MecHnd/Chuk
- ShkAbs
- FJ
- FK
- SpdContr
- Ending
- LSH-HP
- LSH
- FH100
- BSA2
- BHA/BHG
- LHA
- LHAG
- HAP
- HKP
- HCP
- HGP
- HLF2
- HLA/HLB
- HLAG/HLBG
- HLC
- HLD
- HMF
- HMF-G
- HMFB
- HFP
- FH500
- HBL
- HJL
- HMD
- HDL
- HJD
- BHE

Dimensions

● HFP-2CS Standard

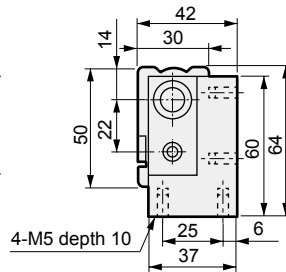
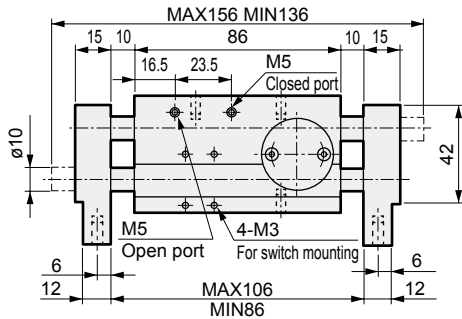
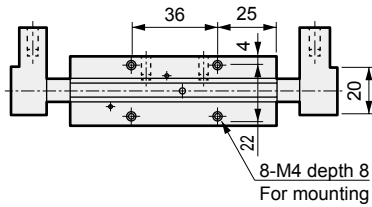

● With switch

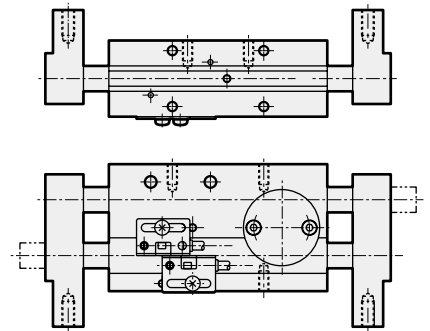

● HFP-3CS Standard

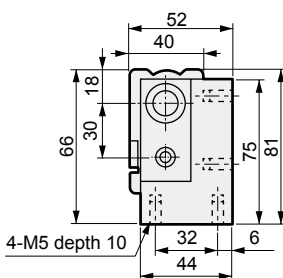
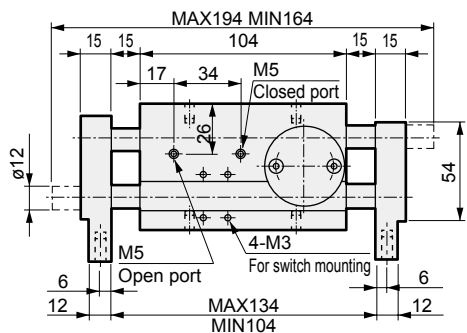
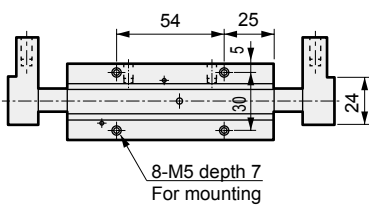

● With switch

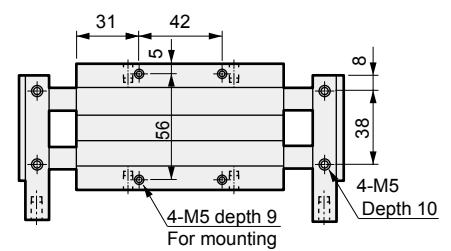
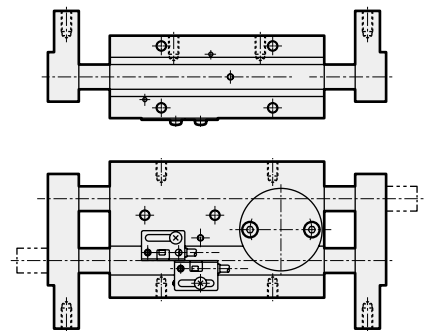

LCM
LCR
LCG
LCW
LCX
STM
STG
STS/STL
STR2
UCA2
ULK*
JSK/M2
JSG
JSC3/JSC4
USSD
UFCD
USC
UB
JSB3
LMB
LML
HCM
HCA
LBC
CAC4
UCAC2
CAC-N
UCAC-N
RCS2
RCC2
PCC
SHC
MCP
GLC
MFC
BBS
RRC
GRC
RV3*
NHS
HRL
LN
Hand
Chuk
MechHnd/Chuk
ShkAbs
FJ
FK
SpdContr
Ending
LSH-HP
LSH
FH100
BSA2
BHA/BHG
LHA
LHAG
HAP
HKP
HCP
HGP
HLF2
HLA/HLB
HLAG/HLBG
HLC
HLD
HMF
HMF-G
HMFB
HFP
FH500
HBL
HJL
HMD
HDL
HJD
BHE

HFP Series

Dimensions



● HFP-4CS Standard

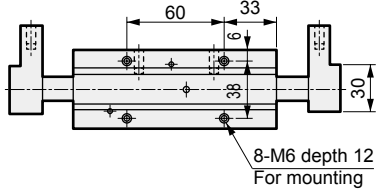

● With switch

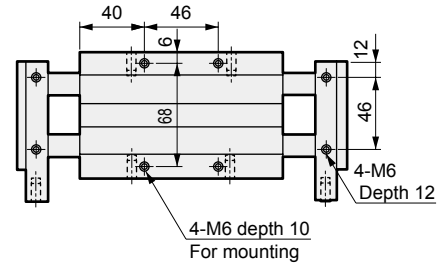
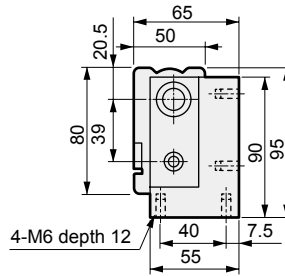
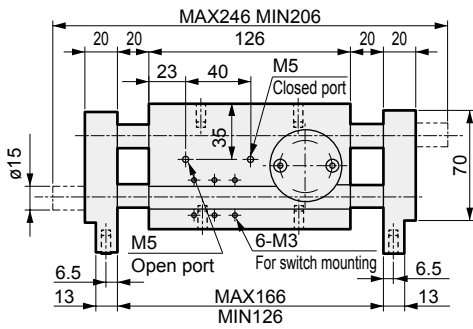
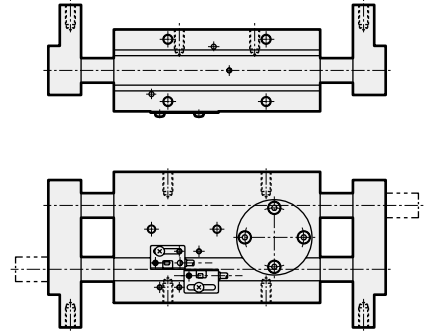

● HFP-5CS Standard

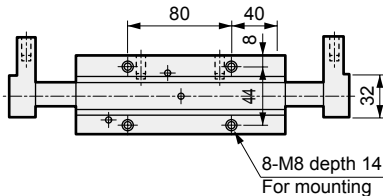

● With switch

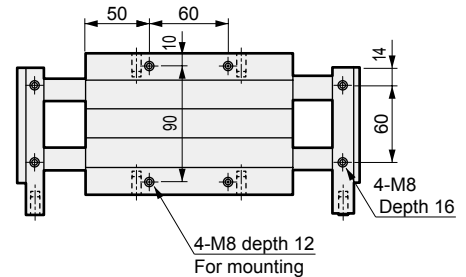
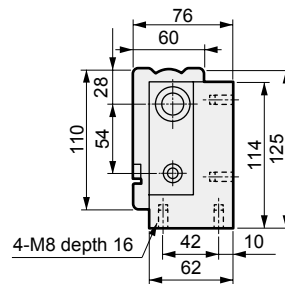
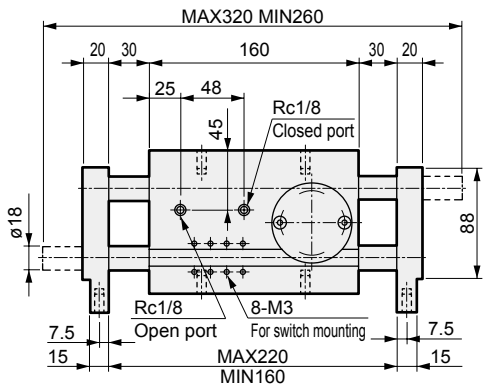
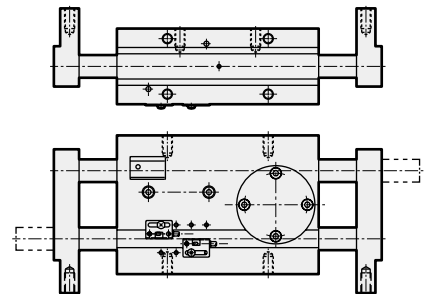

- LCM
- LCR
- LCG
- LCW
- LCX
- STM
- STG
- STS/STL
- STR2
- UCA2
- ULK*
- JSK/M2
- JSG
- JSC3/JSC4
- USSD
- UFCD
- USC
- UB
- JSB3
- LMB
- LML
- HCM
- HCA
- LBC
- CAC4
- UCAC2
- CAC-N
- UCAC-N
- RCS2
- RCC2
- PCC
- SHC
- MCP
- GLC
- MFC
- BBS
- RRC
- GRC
- RV3*
- NHS
- HRL
- LN
- Hand
- Chuk
- MecHnd/Chuk
- ShkAbs
- FJ
- FK
- SpdContr
- Ending

- LSH-HP
- LSH
- FH100
- BSA2
- BHA/BHG
- LHA
- LHAG
- HAP
- HKP
- HCP
- HGP
- HLF2
- HLA/HLB
- HLAG/HLBG
- HLC
- HLD
- HMF
- HMF-G
- HMFB
- HFP
- FH500
- HBL
- HJL
- HMD
- HDL
- HJD
- BHE