

2 Search by product series

Select from external appearance and product description of each series.

NEW indicates models added to the 9th edition.

Standard Pneumatic Cylinders I - P.1

Standard/small bore size cylinders(ø2.5 to ø16)

Pencil type compact cylinder

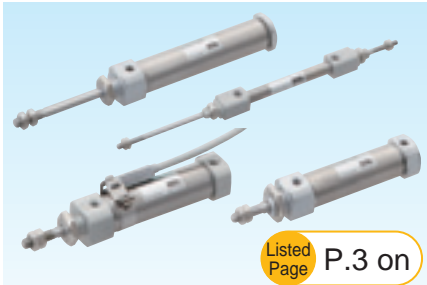

Listed Page P.3 on

Pencil shaped cylinder

SCP*3

Series	Also known as...	Bore size (ø)	Page
SCPD3	Single rod	6, 10, 16	8
SCPS	Single acting/push	2.5, 4	16
SCPS3	Single acting/push	6, 10, 16	16
SCPH3	Single acting/pull	6, 10, 16	16
SCPD3-T	Heat resistance		26
SCPD3-*C	With rubber-air cushion		28
SCPD3-F	Fine speed	6, 10, 16	34
SCPD3-O	Low speed		40
SCPD3-D	Double rod		44
SCPD3-Z	With speed controller		50
SCP*3-M	Rotation-stop	10, 16	56
SCPD3-K	High load	6, 10, 16	64
SCP*3-V	With valve	10, 16	70

Standard/medium bore size cylinders(ø20 to ø40)

Stainless steel tube for high corrosion resistance



Listed Page P.81 on

Medium bore size cylinder

CMK2

Series	Also known as...	Bore size (ø)	Page
CMK2	Single rod		86
CMK2-S	Single acting/push		100
CMK2-SR	Single acting/pull		106
CMK2-P	Stroke adjustable (push)		112
CMK2-R	Stroke adjustable (pull)		118
CMK2-T	Heat resistance		124
CMK2-*C	With rubber-air cushion		128
CMK2-C	Air cushion	20, 25, 32, 40	136
CMK2-Q	Position locking		142
CMK2-F	Fine speed		148
CMK2-D	Double rod		154
CMK2-B	Back-to-back		160
CMK2-M	Rotation-stop		166
CMK2-Z	Integrated speed controller		172
CMK2-H	Low hydraulic		178
CMK2-G2/G3	Coolant proof		182
NEW CMK2-JG2/JG3	Stainless steel		188

Standard/medium bore size cylinders(ø20 to ø40)

Maintenance possible disassembly type



Listed Page P.205 on

Medium bore size cylinder

CMA2

Series	Also known as...	Bore size (ø)	Page
CMA2	Single rod	20, 30, 40	208
CMA2-E	Direct mounting		222

Standard/medium bore size cylinders(ø20 to ø100)

Smart type with wide range of bore sizes/options



Listed Page P.227 on

Round shaped cylinder

SCM

Series	Also known as...	Bore size (ø)	Page
SCM	Single rod	20 to 100	232
SCM-X	Single acting/push	20 to 40	254
SCM-Y	Single acting/pull	20 to 40	260
SCM-P	Stroke adjustable (push)	20 to 63	266
SCM-R	Stroke adjustable (pull)	20 to 63	272
SCM-T	Heat resistance	20 to 100	278
SCM-Q	Position locking	20 to 100	282
SCM-F	Fine speed	20 to 40	292
SCM-O	Low speed	20 to 100	298
SCM-U	Low friction	20 to 100	302
SCM-D	Double rod		308
SCM-B	Back to back		316
SCM-W	Two-stage		322
SCM-W4	Tandem	20 to 63	328
SCM-M	Rotation-stop		334
SCM-LD	Direct mounting foot		340

Standard/medium bore size cylinders (ø32 to ø100)

Eco-friendly tie rod cylinder



Listed Page P.351 on

Tie rod cylinder

SCG

Series	Also known as...	Bore size (ø)	Page
SCG	Single rod		358
SCG-Q	Position locking		374
SCG-O	Low speed	32 to 100	396
SCG-U	Low friction		402
SCG-D	Double rod		406
SCG-M	Rotation-stop	32 to 63	412
SCG-G	Rubber scraper	32 to 100	418
SCG-G2/G3	Coolant proof	40 to 100	424
SCG-G4	Anti-spatter adherence	32 to 100	430

Standard/medium bore size cylinders (ø40 to ø100)

Robust type, No.1 reliability



Listed Page P.443 on

Medium bore size cylinder

SCA2

Series	Also known as...	Bore size (ø)	Page
SCA2	Single rod		450
SCA2-P	Stroke adjustable (push)		472
SCA2-R	Stroke adjustable (pull)		480
SCA2-T	Heat resistance		488
SCA2-Q2	Position locking		494
SCA2-O	Low friction		526
SCA2-U	Low friction		534
SCA2-D	Double rod	40, 50, 63, 80, 100	540
SCA2-B	Back to back		548
SCA2-W	Two-stage		556
SCA2-K	Steel tube		564
SCA2-H	Low hydraulic		568
SCA2-G	Scraper		576
SCA2-G2/G3	Coolant proof		584
SCA2-G1/G4	Anti-spatter adherence		590
SCA2-V	With valve		596

Cylinders I: **Standard, with valve**, space saving, rodless

Cylinders II: Combined functions, with brake/position locking, high speed, special, oscillation/rotation drive, unit components, length measurement function, hand/chuck, related products

Standard/large bore size cylinders (ø125 to ø250)

Wide range of choices and high rigidity



Listed Page P.621 on

Large bore size cylinder

SCS2

Series	Also known as...	Bore size (ø)	Page
SCS2	Lubrication	125, 140, 160, 180, 200, 250	626
SCS2-N	No-lubrication		626
SCS2-P	Stroke adjustable (push)		640
SCS2-T	Heat resistance		644
SCS2-D	Double rod/lubrication		648
SCS2-ND	Double rod/no-lube		648
SCS2-B	Back to back		654
SCS2-W	Two-stage		658
SCS2-H	Low hydraulic		662
SCS2-G	Rubber scraper		668

With valve ▶▶▶ Pneumatic Cylinders I - P.673

With valve/medium bore size cylinders (ø20 to ø40)

CMK2 Series is equipped with high performance solenoid valve

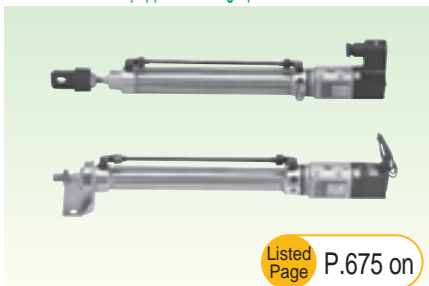

Listed Page P.675 on

Small cylinder with valve

CKV2

Series	Also known as...	Bore size (ø)	Page
CKV2	Single rod	20, 25, 32,	680
CKV2-M	Rotation-stop	40	692

With valve (ø50/75/100)

Years of consistent reliability

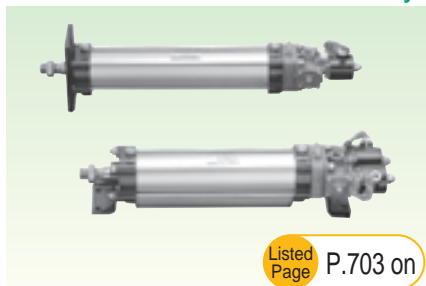

Listed Page P.703 on

Cylinder with valve

CAV2/COV_N2

Series	Also known as...	Bore size (ø)	Page
CAV2	Double solenoid/lubrication	50, 75, 100	710
COVP2	Single solenoid/push out when energized/lubrication		710
COVN2	Single solenoid/retracted in when energized/lubrication		710
CAV2-N	Double solenoid/no-lubrication		710
COVP2-N	Single solenoid/push out when energized/no-lubrication		710
COVN2-N	Single solenoid/retracted in when energized/no-lubrication		710

Other with valve

The following "Cylinder with valve" product lineup is also available.

Product name	Series	Bore size (ø)	Page
Pencil shaped cylinder	SCPS3-V	10, 16	I-70
	SCPD3-V		
Medium bore size cylinder	SCA2-V	40, 50, 63, 80, 100	I-596
Guided cylinder	ST S/L-M/B V	20 to 63	II-544
	ULK-V	20, 25, 32, 40	II-680
	JSK2-V	20, 25, 32, 40	II-706
Brake cylinder	JSM2-V	20, 25, 32, 40	II-720
	JSG-V	40, 50, 63, 80, 100	II-742
	JSC3-V	40, 50, 63, 80, 100	II-810
Rotary actuator	RV3S V/W RV3D V/W	0.98 to 66.6 (Torque size)	II-1372

2 Search by product series

Select from external appearance and product description of each series.

NEW indicates models added to the 9th edition.

Space saving structure ▶▶▶ Pneumatic Cylinders I - P.743

Space saving/super compact(ø12 to ø200)
Wide variations/switch 4 surface mounting compact



Listed Page P.745 on

Compact cylinder

SSD2

Series	Also known as...	Bore size (ø)	Page
SSD2	Single rod	12 to 200	752
SSD2-K	High load	12 to 100	776
SSD2-L	Long stroke		792
SSD2-X	Push type	12 to 50	802
SSD2-Y	Pull type		802
SSD2-T1	Heat resistance	12 to 100	820
SSD2-T1L	With heat resist cylinder switch	16 to 63	824
SSC2-K-°C	High load/with rubber-air cushion	20 to 100	832
SSD2-Q	Position locking	12 to 100	840
SSD2-F/SSD2-KF	Fine speed/high load/fine speed		854
SSD2-O	Low speed	20 to 100	858
SSD2-KU	High load/low friction		864
SSD2-D	Double rod	12 to 100	868
SSD2-B	Back to back		890
SSD2-W	Two-stage	12 to 63	902
SSD2-M	Rotation-stop		910
SSD2-DM	Double rod/rotation-stop	20 to 100	924
SSD2-G	Rubber scraper		936
SSD2-G2/G3	Coolant proof	16 to 100	946
SSD2-KG2/KG3	High load/coolant proof		956
SSD2-G1	Coil scraper	25 to 100	966
SSD2-G4	Anti-spatter adherence		966
SSD2-KG1	High load/coil scraper	25 to 100	974
SSD2-KG4	High load/anti-spatter adherence		974
SSD2-DG1	Double rod/coil scraper	20 to 100	984
SSD2-DG4	Double rod/anti-spatter adherence		984
SSD2-G5	Environment-resistant scraper	40 to 100	992
SSD2-KG5	Hi load/environment-resist scraper		1002
SSD2-L4	With strong magnetic field proof switch	40 to 100	1012
SSD2-G1L4	With strong magnetic field proof switch/with coil scraper		1018
SSD2-KL4	Hi load/strong magnetic field proof switch	40 to 100	1024
SSD2-KG1L4	Hi load/strong magnetic field proof switch/coil scraper		1030
SSD2-P7*	Clean-room specifications	12 to 160	1036

Space saving/with guide/super compact(ø12 to ø100)
SSD2 Series is equipped with a guide rod

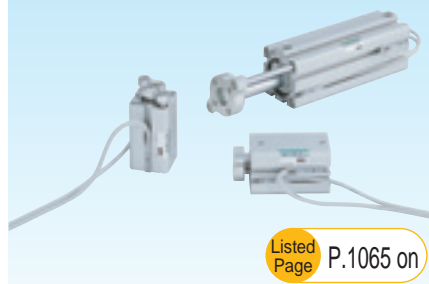

Listed Page P.1065 on

Guided super compact cylinder

SSG

Series	Also known as...	Bore size (ø)	Page
SSG	Single rod	12 to 100	1068

Space saving/compact single acting(ø6 to ø15)
Outside diameter is full-thread thumb size

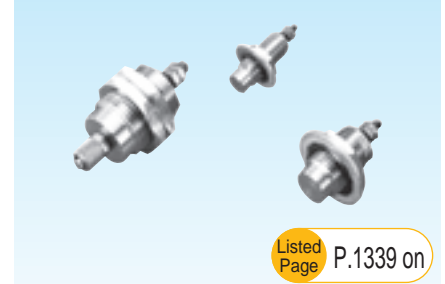

Listed Page P.1339 on

Cartridge cylinder

CAT

Series	Also known as...	Bore size (ø)	Page
CAT	Single acting/push	6, 10, 15	1340

Space saving/super compact (ø12 to ø160)
Compact with wide range of bore sizes/options



Listed Page P.1081 on

Compact cylinder

SSD

Series	Also known as...	Bore size (ø)	Page
SSD	Single rod	12 to 160	1094
SSD-K	Single rod high load	12 to 100	1116
SSD-X	Single acting/push	12, 16, 20, 25,	1126
SSD-Y	Single acting/pull	32, 40, 50	1126
SSD-T	Heat resistance	12 to 100	1138
SSD-T1L	With heat resist cylinder switch	16 to 63	1142
SSD-K-°C	High load/with rubber-air cushion	32 to 100	1150
SSD-Q	Position locking	16 to 100	1160
SSD-F	Fine speed	12 to 100	1172
SSD-KF	High load/fine speed		1172
SSD-O	Low speed	20 to 100	1178
SSD-KU	High load/low friction		1184
SSD-D	Double rod	12 to 160	1188
SSD-B	Back to back	12 to 100	1200
SSD-W	Two-stage		1210
SSD-M	Rotation-stop	12 to 63	1220
SSD-G2/G3	Coolant proof	16 to 100	1230
SSD-K G2/G3	High load, coolant proof		1238
SSD-G1/G4	Anti-spatter adherence	25 to 100	1246
SSD-K G1/G4	Hi load, anti-spatter adherence		1254
SSD-D G1/G4	Double rod, anti-spatter adherence	20 to 100	1264
SSD-G5	Environment-resistant scraper		1272
SSD-KG5	Hi load/environment-resist scraper	20 to 100	1280
SSD-L4	With strong magnetic field proof switch	40 to 100	1288
SSD-G1L4	With strong magnetic field proof switch/with coil scraper		1294
SSD-KL4	Hi load strong magnetic field proof with switch	40 to 100	1300
SSD-KG1L4	Hi load, strong magnetic field proof switch, coil scraper		1306

Space saving/direct mount (ø4 to ø10)
Can be mounted directly from 4 directions

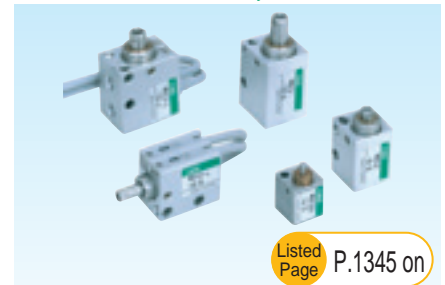

Listed Page P.1345 on

Small direct mounting cylinder

MDC2

Series	Also known as...	Bore size (ø)	Page
MDC2	Single rod	4, 6, 8, 10	1348
MDC2-X	Push type		1354
MDC2-Y	Pull type		1354
MDC2-F	Fine speed		1364

Cylinders I: Standard, with valve, **space saving**, rodless

Cylinders II: Combined functions, with brake/position locking, high speed, special, oscillation/rotation drive, unit components, length measurement function, hand/chuck, related products

Space saving/with small suction pad ($\phi 6/\phi 10$)
Equipped with suction pad on the rod end



Listed Page P.1371 on

Small cylinder with suction pad

MVC

Series	Also known as...	Bore size (ϕ)	Page
MVC	Single rod	6, 10	1374

Space saving/multisurface installation ($\phi 6$ to $\phi 32$)
More compact than conventional products, direct mount



NEW

Listed Page P.1383 on

Compact cylinder

SMG

Series	Also known as...	Bore size (ϕ)	Page
SMG	Single rod	6 to 32	1386
SMG-X	Push type		1392
SMG-Y	Pull type		1392
SMG-F	Fine speed		1400
SMG-M	Rotation-stop		1404

Space saving/compact ($\phi 6$ to $\phi 16$)
SSD small bore size series. Also available with high precision guide

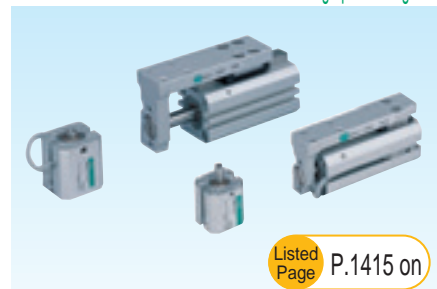

Listed Page P.1415 on

Small compact cylinder

MSD/MSDG

Series	Also known as...	Bore size (ϕ)	Page
MSD	Single rod	6, 8	1422
MSD-X	Single acting/push		1430
MSD-Y	Single acting/pull		1430
MSD-K	High load	6, 8, 12, 16	1440
MSD-F	Fine speed	6, 8	1450
MSD-KF	High load/fine speed	6, 8, 12, 16	1450
MSDG-L	Guided		1452
MSDG-LF	Guided/fine speed	12, 16	1462

Space saving/flat type ($\phi 25$ to $\phi 63$)
Mountable even in narrow spaces. With rotation-stop function

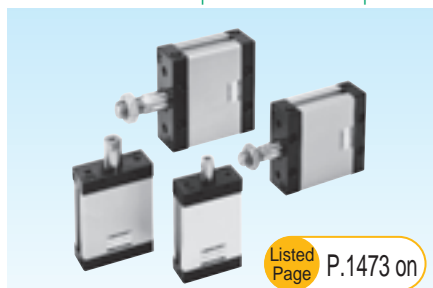

Listed Page P.1473 on

Flat compact cylinder

FC*

Series	Also known as...	Bore size (ϕ)	Page
FCS	Single acting/push	25, 32, 40, 50, 63 or equiv.	1480
FCH	Single acting/pull		1480
FCD	Single rod		1488
FCD-D	Double rod		1494
FCD-K	Cushioned		1500

Stopper cylinder ($\phi 20$ to $\phi 50$)
Space-saving with excellent lateral load resistance



Listed Page P.1509 on

Stopper cylinder

STK

Series	Also known as...	Bore size (ϕ)	Page
STK	Round rod end form type	20, 32, 40, 50	1512
STK-Y	Single acting/pull/round rod end form type		1518
STK-Y1	Spring integrated/round rod end form type		1524
STK-M	Rod end form chamfered type		1530
STK-MY	Single acting/pull/rod end form chamfered type		1536
STK-MY1	Spring integrated/rod end form chamfered type		1542
STK-JY	Single acting/pull/rod end form roller		1548
STK-JY1	Spring integrated/rod end form roller		1554

2 Search by product series

Select from external appearance and product description of each series.

NEW indicates models added to the 9th edition.

Rodless Pneumatic Cylinders I - P.1567

Rodless/basic (ø12 to ø100)

Wide range of bore sizes/choices



Listed Page P.1569 on

Rodless cylinder

SRL3

Series	Also known as...	Bore size (ø)	Page
SRL3	Standard	12, 16, 20,	1574
SRL3-G	With resin guide	25, 32, 40,	1590
SRL3-Q	With position locking function	50, 63, 80,	1604
SRL3-GQ	With resin guide/ With position locking function	100 or equiv.	1614

Rodless/with high precision guide (ø12 to ø25)

Integrated high precision LM guide

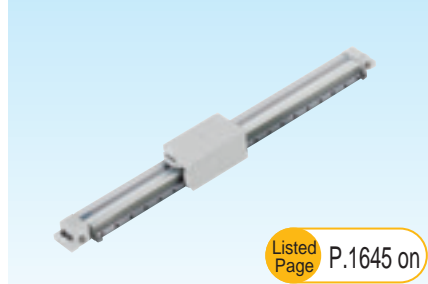

Listed Page P.1645 on

High precision guided rodless cylinder

SRG3

Series	Also known as...	Bore size (ø)	Page
SRG3	Standard	12, 16, 20, 25 or equiv.	1650

Rodless/with high precision guide (ø25 to ø63)

2-axis uses high precision LM guide. Improved rigidity

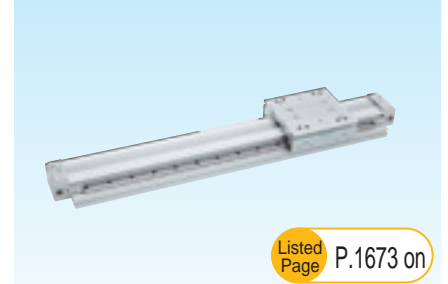

Listed Page P.1673 on

High precision guided rodless cylinder

SRM3

Series	Also known as...	Bore size (ø)	Page
SRM3	Double acting	25, 32, 40,	1676
SRM3-Q	Double acting/position locking	63 or equiv.	1676

Rodless/with brake (ø12 to ø63)

Highly reliable built-in brake type



Listed Page P.1703 on

Rodless cylinder with brake

SRT3

Series	Also known as...	Bore size (ø)	Page
SRT3	Double acting	12, 16, 20, 25, 32, 42, 50, 63 or equiv.	1706

Rodless/magnet (ø6 to ø32)

Rodless and space-saving

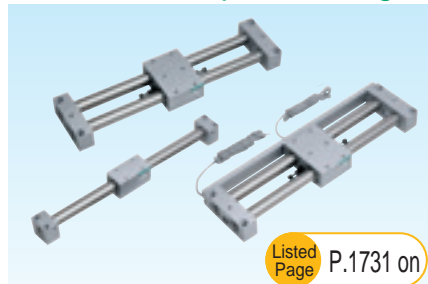

Listed Page P.1731 on

Magnet rodless cylinder

MRL2

Series	Also known as...	Bore size (ø)	Page
MRL2	Basic (guide combined)		1740
MRL2-G	Simplified guide/1 piston	6, 10, 16,	1740
MRL2-W	Simplified guide/2 piston	20, 25, 32	1740
MRL2-F	Fine speed		1740

Magnet with high precision guide (ø10 to ø25)

MRL2 has high precision LM guide integrated



Listed Page P.1763 on

Magnet rodless cylinder with high precision guide

MRG2

Series	Also known as...	Bore size (ø)	Page
MRG2	Double acting	10, 16, 25	1766

Rodless/shuttle mover (ø25)

Curved rodless. Free layout is possible

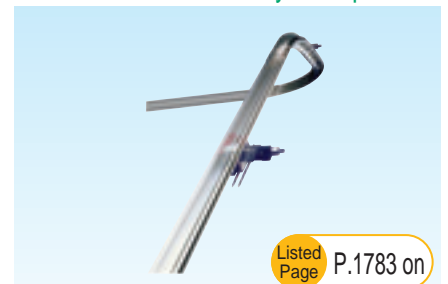

Listed Page P.1783 on

Shuttle mover standard/high load

SM-25

Series	Also known as...	Bore size (ø)	Page
SM-25	Standard	25	1784
	High load		

Cylinders I: Standard, with valve, space saving, **rodless**

Cylinders II: **Combined functions**, with brake/position locking, high speed, special, oscillation/rotation drive, unit components, length measurement function, hand/chuck, related products

Combined functions >>> Pneumatic Cylinders II - P.1

Combined functions/with high precision guide (ø4.5 to ø8)

Compact with high precision/rigidity

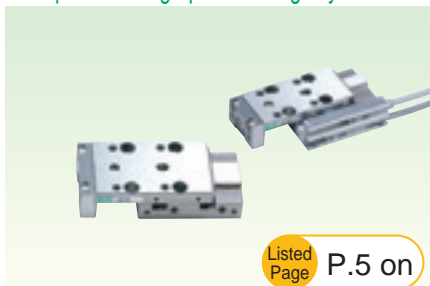

Listed Page P.5 on

Linear slide cylinder

LCM

Series	Also known as...	Bore size (ø)	Page
LCM	Single rod	4.5 to 8	10
LCM-P	Stroke adjustable (push)		18
LCM-R	Stroke adjustable (push/pull)		24
LCM-A	Side installation		30
LCM-P73	Clean-room specifications		40

Combined functions/with high precision guide (ø6 to ø25)

Drastically lighter, improved rigidity

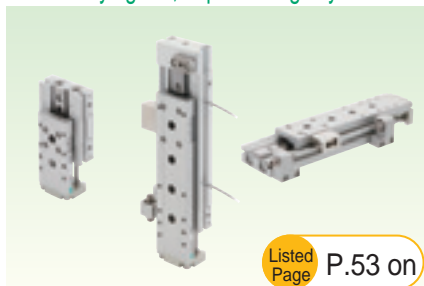

Listed Page P.53 on

Linear slide cylinder

LCR

Series	Also known as...	Bore size (ø)	Page
LCR	Basic	6 to 25	58
LCR-Q	Position locking	8 to 25	84
LCR-P7*	Clean-room specifications	6 to 25	94
LCR-F	Fine speed	12, 16, 20, 25	112
LCR-F-P7*	Fine speed/clean-room specs	12 to 25	118

Combined functions/with high precision guide (ø6 to ø25)

Focused on high precision/high rigidity. Easier to use

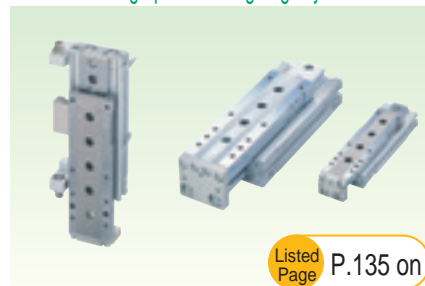

Listed Page P.135 on

Linear slide cylinder

LCG

Series	Also known as...	Bore size (ø)	Page
LCG	Single rod	6 to 25	140
LCG-Q	Position locking	8 to 25	164
LCG-P7*	Clean-room specifications	6 to 25	172

Combined functions/with high precision guide (ø12 to ø20)

Specs most used by customers are provided as standard



NEW

Listed Page P.199 on

Linear slide cylinder

LCW

Series	Also known as...	Bore size (ø)	Page
LCW	Single rod	12 to 20	204
LCW-Q	Position locking		224

Combined functions/with high precision guide (ø25, ø32)

Drastically slimmer, thus ideal for space saving applications

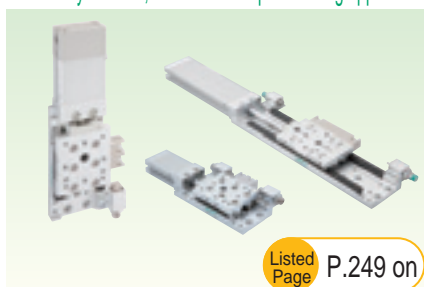

Listed Page P.249 on

Thin linear slide cylinder

LCX

Series	Also known as...	Bore size (ø)	Page
LCX	Single rod	25, 32	254
LCX-Q	Position locking		264
LCX-P7*	Clean-room specifications		270
LCX-*L	Long stroke		276
LCX-Q-*L	Position locking/long stroke		286
LCX-*L-P7*	Clean-room specifications/long stroke		292

2 Search by product series

Select from external appearance and product description of each series.

NEW indicates models added to the 9th edition.

Combined functions >>> Pneumatic Cylinders II - P.1

Combined functions/guided cylinder (ø6, ø10)
Space saving with compact guide

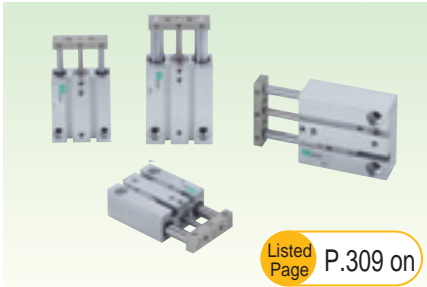

Listed Page P.309 on

Guided cylinder

STM

Series	Also known as...	Bore size (ø)	Page
STM-M/B	Single rod	6, 10	314
STM-B-P7*	Clean-room specifications		320

Combined functions/guided cylinder (ø12 to ø100)
Environment-friendly product. Load resistance improved

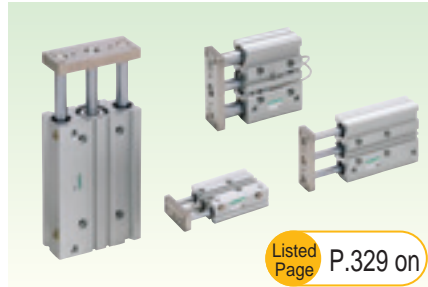

Listed Page P.329 on

Guided cylinder

STG

Series	Also known as...	Bore size (ø)	Page
STG-M/B	Single rod	12 to 100	336
STG-M/B- [*] C	Rubber-air cushioned	32 to 63	350
STG-M/B C	Air cushion	16 to 63	358
STG-M/B Q	Position locking	20 to 63	368
STG-M/B G	Rubber scraper		376
STG-M/B G1	Coil scraper		376
STG-MG2/MG3	Coolant proof		382
STG-M/B G4	Anti-spatter adherence		40 to 63
STG-MG5	Environment-resistant scraper	20 to 100	394
STG-B-P7*	Clean-room specifications	12 to 63	404
STG-K	Heavy duty guide rod	32, 50	430

Combined functions/guided cylinder (ø8 to ø100)
Wide range of bore sizes/choices

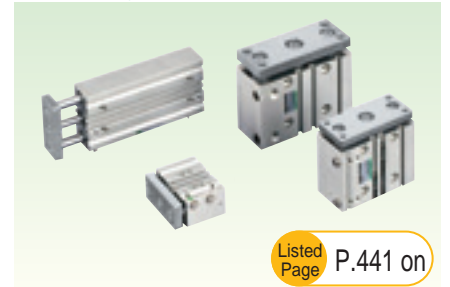

Listed Page P.441 on

Guided cylinder

STS/STL

Series	Also known as...	Bore size (ø)	Page
ST S/L-M/B	Single rod	8 to 100	448
ST S/L-M/B P	Stroke adjustable (push)	8 to 80	470
ST S/L-M/B T	Heat resistance	12 to 80	476
ST S/L-M/B T2	Packing material fluoro rubber		480
ST S/L-M/B- [*] C	Rubber-air cushioned	32 to 80	486
ST S/L-M/B C	Air cushion	25 to 80	492
ST S/L-M/B Q	Position locking	20 to 80	500
ST S/L-M/B F	Fine speed	8 to 80	512
ST S/L-M/B O	Low speed		514
ST S/L-M/B G	Rubber scraper/	20 to 80	518
ST S/L-M/B G1	Coil scraper		526
ST S/L-M/B G 2/3	Coolant proof	40 to 80	536
ST S/L-M/B G4	Anti-spatter adherence	20 to 63	544
ST S/L-M/B V	Valve equipped		

Combined functions/twin rod cylinder (ø6 to ø32)
High non-rotating accuracy with twin rod. For pick & place applications

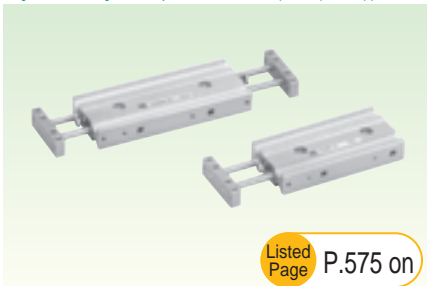

Listed Page P.575 on

Twin rod cylinder

STR2

Series	Also known as...	Bore size (ø)	Page
STR2-M/B	Standard	6, 10, 16, 20, 25, 32	580
STR2-M/B Q	Position locking	16, 20, 25, 32	592
STR2-M/B O	Low speed	6, 10, 16, 20, 25, 32	602
STR2-M/B F	Fine speed	10, 16, 20, 25, 32	610
STR2-M/B D	Double rod	6, 10, 16, 20, 25, 32	612

Combined functions/unit cylinder (ø10 to ø32)
Stable position accuracy with double rod structure

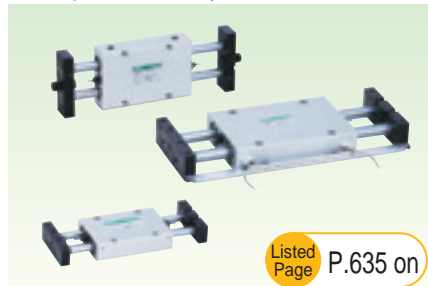

Listed Page P.635 on

Unit cylinder

UCA2

Series	Also known as...	Bore size (ø)	Page
UCA2	Metal bush bearing	10, 16,	640
UCA2-B	Ball bearing	25, 32	650

Cylinders I: Standard, with valve, space saving, rodless

Cylinders II: **Combined functions, with brake/position locking**, high speed, special, oscillation/rotation drive, unit components, length measurement function, hand/chuck, related products

With brake/position locking ▶▶▶ Pneumatic Cylinders II - P.669

With brake/small medium bore size (ø16 to ø40)
Pencil type, etc. with high performance compact brake

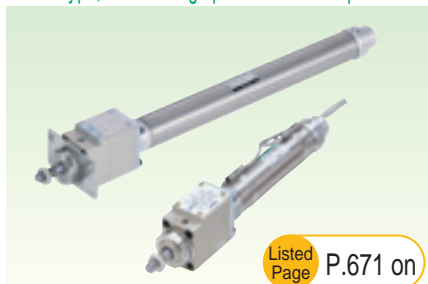

Listed Page P.671 on

Brake cylinder (small/medium bore size)

ULKP/ULK

Series	Also known as...	Bore size (ø)	Page
ULKP	Single rod	16	674
ULK		20, 25, 32, 40	680
ULK-V	With valve	20, 25, 32, 40	680

With brake/small medium bore size (ø20 to ø40)
CMK2/CMA2 equipped with highly reliable built-in brake

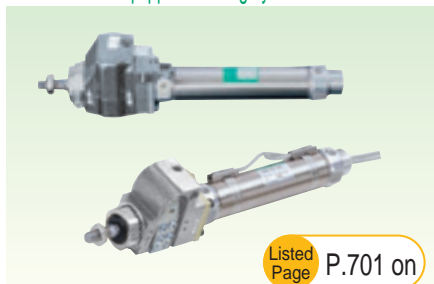

Listed Page P.701 on

Brake cylinder (small/medium bore size)

JSK2/JSM2

Series	Also known as...	Bore size (ø)	Page
Caulking model			
JSK2	Single rod	20, 25, 32,	706
JSK2-V	With valve	40	706
Disassembly type			
JSM2	Single rod	20, 30, 40	720
JSM2-V	With valve		720

With brake/medium bore size (ø40 to ø100)
SCG equipped with highly reliable built-in brake mechanism

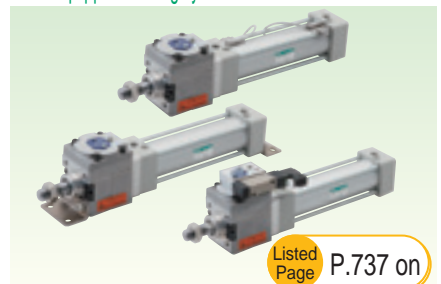

Listed Page P.737 on

Tie rod cylinder with brake

JSG

Series	Also known as...	Bore size (ø)	Page
JSG	Single rod	40, 50	742
JSG-V	With valve for brake release	63, 80, 100	

With brake/medium large bore size (ø40 to ø180)
Highly reliable robust cylinders equipped with brake



Listed Page P.767 on

Brake cylinder (medium and large bore size)

JSC3/JSC4

Series	Also known as...	Bore size (ø)	Page
JSC3	Single rod	40 to 100	774
JSC4	Single rod	125 to 180	774
JSC3-V	With valve for brake	40 to 100	810
JSC3-H	Low hydraulic	40 to 100	818
JSC4-H	Low hydraulic	125 to 180	818
JSC3-T	Heat resistance	40 to 100	830
JSC4-T	Heat resistance	125 to 180	830

With position locking (ø20 to ø100)
Compact SSD equipped with position locking function



Listed Page P.841 on

Position locking compact cylinder

USSD

Series	Also known as...	Bore size (ø)	Page
USSD	Single rod	20, 25, 32,	846
USSD-K	High load	40, 50, 63, 80, 100	

With position locking (ø25 to ø63)
Flat cylinder FCD Series equipped with position locking function



Listed Page P.885 on

Free position locking flat cylinder

UFCD

Series	Also known as...	Bore size (ø)	Page
UFCD-KL	Single rod/cushioned	25 to 63	888

2 Search by product series

Select from external appearance and product description of each series.

NEW indicates models added to the 9th edition.

With brake/position locking ▶▶▶ Pneumatic Cylinders II - P.669

With position locking (ø40 to ø100)
Position locking possible at any position



Listed Page P.901 on

Free position locking medium bore size cylinder

USC

Series	Also known as...	Bore size (ø)	Page
USC	Single rod	40 to 100	904
USC-G1	With coil scraper		904

Lightweight. Slim lock unit
"Fixing," "improved safety," and "position locking" are possible



NEW

Listed Page P.927 on

Lock unit

UB

Series	Applicable shaft diameter	Page
UB	8, 16	930

With brake/brake unit
Brake section installed in brake cylinder alone integrated into a unit

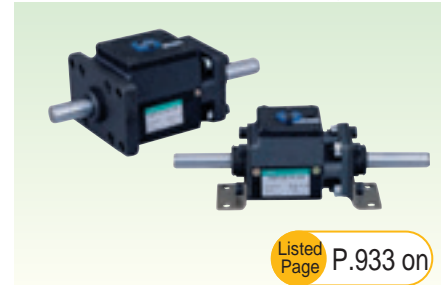

Listed Page P.933 on

Brake unit

JSB3

Series	Rod diameter	Page
JSB3	16, 20, 25, 30, 35, 40, 45	936

With brake/LM guide brake
Highly reliable brake mounted to LM guide

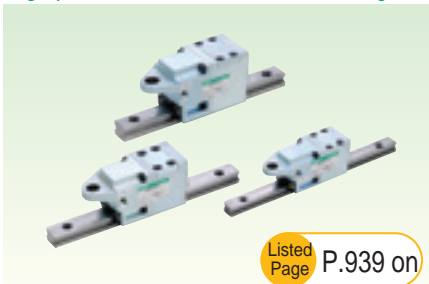

Listed Page P.939 on

Linear guide lock

LMB

Series	Page
LMB	942

With brake function/lock unit
Compact linear guide with strong holding force

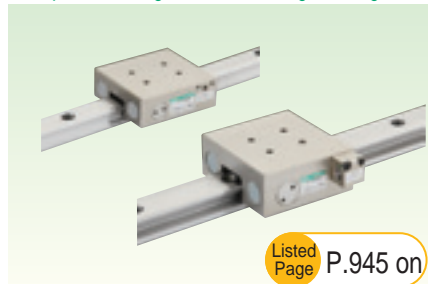

Listed Page P.945 on

Linear guide lock

LML

Series	Page
LML	947

High speed ▶▶▶ Pneumatic Cylinders II - P.953

High speed/high speed cylinder(ø20 to ø63)
High speed operation at 2000 mm/s. High cushion performance



Listed Page P.957 on

High energy absorption cylinder

HCM

Series	Also known as...	Bore size (ø)	Page
HCM	Single rod	20 to 63	960

High speed/high speed cylinder(ø20 to ø100)
High speed operation at 3000 mm/s. High cushion performance



Listed Page P.975 on

High speed cylinder

HCA

Series	Also known as...	Bore size (ø)	Page
HCA	Single rod	20, 25, 32, 40, 50, 63, 80, 100	978

Cylinders I: Standard, with valve, space saving, rodless

Cylinders II: Combined functions, **with brake/position locking, high speed, special** oscillation/rotation drive, unit components, length measurement function, hand/chuck, related products

Special

▶▶▶ Pneumatic Cylinders **II** - P.993

Air static pressure soft actuator

“Zero” sliding resistance achieved



Listed Page P.995 on

Air bearing actuator

LBC

Series	Also known as...	Page
LBC	Push type	998

Combined functions/clamp cylinder (ø40 to ø80)

Clamp dedicated cylinder



Listed Page P.1005 on

Clamp cylinder

CAC4

Series	Also known as...	Bore size (ø)	Page
CAC4	Single rod	40, 50, 63, 80	1008
CAC4-G4	Anti-spatter adherence	40, 50, 63, 80	1020

With brake/position locking (ø50/ø63)

Clamp cylinder equipped with position locking function



Listed Page P.1029 on

Position locking clamp cylinder

UCAC2

Series	Also known as...	Bore size (ø)	Page
UCAC2	Single rod	50, 63	1030

Combined functions/clamp cylinder (ø32/ø40)

Clamp dedicated, contributes to reduction of welding jig weight



Listed Page P.1043 on

Lightweight clamp cylinder

CAC-N

Series	Also known as...	Bore size (ø)	Page
CAC-N	Single rod	32, 40	1046

With brake/position locking (ø32/ø40)

Equipped with free position locking function



Listed Page P.1043 on

Lightweight clamp cylinder

UCAC-N

Series	Also known as...	Bore size (ø)	Page
UCAC-N	With position locking	32, 40	1052

Rotary clamp (ø12 to ø63)

Simple design makes compact clamping a reality



NEW

Listed Page P.1063 on

Rotary clamp cylinder

RCS2

Series	Also known as...	Bore size (ø)	Page
RCS2	Single rod	12 to 63	1068
RCS2-T2	Packing material fluoro rubber		1078
RCS2-G4	Anti-spatter adherence	32 to 63	1084

2 Search by product series

Select from external appearance and product description of each series.

NEW indicates models added to the 9th edition.

Special ▶▶▶ Pneumatic Cylinders II - P.993

Rotary clamp (ø16 to ø63)

Optimal for clamping in small spaces



Listed Page P.1095 on

Rotary clamp cylinder

RCC2

Series	Also known as...	Bore size (ø)	Page
RCC2	Single rod	16 to 63	1096
RCC2-G4	Anti-spatter adherence	20 to 63	1108

Pin clamp cylinder

Positioning and clamping of workpiece is possible with a single cylinder



NEW

Listed Page P.1117 on

Pin clamp cylinder

PCC

Series	Also known as...	Bore size (ø)	Page
PCC	Single rod	50	1118
PCC-Q	Position locking		1118

End booster(ø40 to ø100)

Booster with end alone. Energy-saving cylinder.



Listed Page P.1137 on

High power cylinder

SHC

Series	Also known as...	Bore size (ø)	Page
SHC	Double force	40 to 100	1144
SHC-K	Quadruple force		1154

Mechanical power cylinder

With just pneumatic source, high thrust equal to hydraulic cylinder is achieved

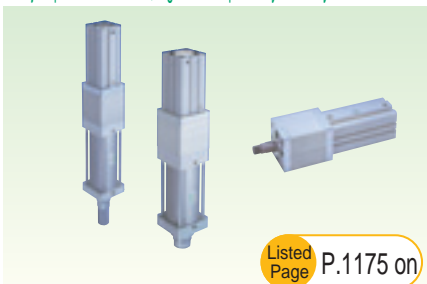

Listed Page P.1175 on

Mechanical power cylinder

MCP

Series	Also known as...	Bore size (ø)	Page
MCP-W	Rapid feed + booster	For 2t/5t	1180
MCP-S	Booster section only		

Combined functions/guideless cylinder (ø40 to ø100)

Rotation-stop without guide, excellent lateral load resistance



Listed Page P.1193 on

Guideless cylinder

GLC

Series	Also known as...	Bore size (ø)	Page
GLC	Single rod	40 to 100	1198

Combined functions/robot cylinder (ø30 to ø80)

Structure that receives a load with the whole frame



Listed Page P.1213 on

Robot cylinder

MFC

Series	Also known as...	Bore size (ø)	Page
MFC	Single rod	30, 40, 50, 63, 80	1218
MFC-K	High load		1218
MFC-B	With brake		1226
MFC-BK	High load with brake		1226
MFC-BS	With brake sensor		1236
MFC-BSK	High load with brake sensor		1236

Cylinders I: Standard, with valve, space saving, rodless

Cylinders II: Combined functions, with brake/position locking, high speed, **special, oscillation/rotation drive, unit components**, length measurement function, hand/chuck, related products

Oscillation/rotation drive ▶▶▶ Pneumatic Cylinders **II** - P.1281

Balancer unit (ø50 to ø100)

Air source alone easily supports heavy objects



Listed Page P.1253 on

Balancer unit

BBS

Series	Also known as...	Bore size (ø)	Page
BBS-A	Auto pressure adjustment	50 to 100	1258
BBS-O	Fixed pressure adjustment		1270

Oscillation/rotation drive 0.7 to 5.6 N•m
Rack and pinion type and compact oscillation



Listed Page P.1283 on

Rotary actuator

RRC

Series	Also known as...	Torque size	Page
RRC	Rack and pinion mechanism	0.7 to 5.6	1286

* Torque size (N•m, at 0.5 MPa)

Oscillation/rotation drive 0.5 to 8.0 N•m
Table actuator. High precision also available

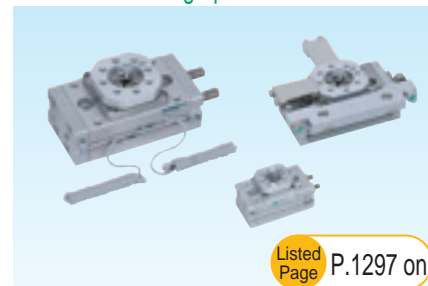

Listed Page P.1297 on

Table rotary actuator

GRC

Series	Also known as...	Torque size	Page
GRC	Basic	0.5 to 8.1	1302
GRC-K	High accuracy	1.0 to 8.1	1302
GRC-F	Fine speed	0.5 to 8.1	1316
GRC-KF	High accuracy/fine speed	1.0 to 8.1	1316

* Torque size (N•m, at 0.5 MPa)

Modular unit ▶▶▶ Pneumatic Cylinders **II** - P.1411

Oscillation/rotation drive 0.12 to 0.66 N•m
Vane type. Wide range of torque sizes.



Listed Page P.1335 on

Rotary actuator with vane mechanism

RV3*

Series	Also known as...	Torque size	Page
Compact			
RV3S	Single vane mechanism	0.12 to 3.19	1338
RV3D	Double vane mechanism	0.28 to 7.70	1338
RV3S V/W	Single vane/with valve	0.98 to 3.19	1350
RV3D V/W	Double vane/with valve	2.11 to 7.70	1350
RV3SA	Angle variable, single vane mech	0.31 to 3.19	1354
RV3DA	Angle variable, double vane mech	0.71 to 7.70	1354
Large			
RV3S (Large)	Single vane mechanism	4.7 to 102	1364
RV3D (Large)	Double vane mechanism	10.1 to 206	1364
RV3S V/W	Single vane/with valve	4.7 to 27.9	1372
RV3D V/W	Double vane/with valve	10.1 to 66.6	1372
RV3SH	Single vane/low hydraulic	4.7 to 102	1378
RV3DH	Double vane/low hydraulic	10.1 to 206	1378
RVC	Shock absorber		1382

* Torque size (N•m, at 0.5 MPa)

Unit components/XYZ-axis combined unit
Selectable X-axis (load capacity), YZ-axis.

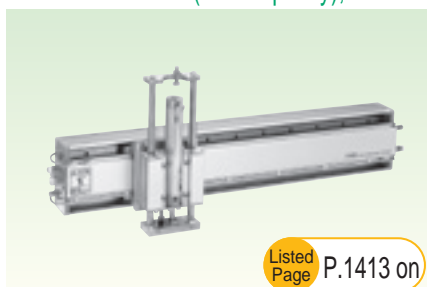

Listed Page P.1413 on

New handling system

NHS

Series	Also known as...	Page
NSR	X-axis module	1422
NHS-H	Z-axis module (HRL)	1430
NHS-S	Z-axis module (STL-B)	1440

Single axis unit
Thin with high rigidity

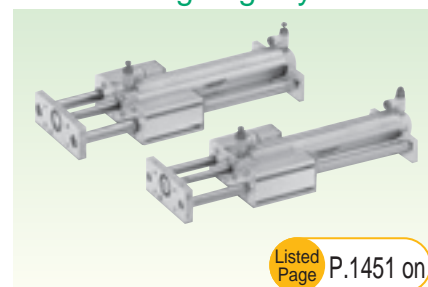

Listed Page P.1451 on

Hybrid robot

HRL

Series	Also known as...	Page
HRL-1	Pneumatic robot element/single-axis unit	1452

2 Search by product series

Select from external appearance and product description of each series.

NEW indicates models added to the 9th edition.

Length measurement function ▶▶▶ Pneumatic Cylinders II - P.1463

Length measurement function/cylinder/hand

Compact cylinder/hand equipped with length measurement function



Listed Page P.1465 on

Cylinder/hand with length measuring sensor

LN

Series	Also known as...	Bore size (ø)	Page
SSD-LN SSD-O-LN	Cylinder with sensor Compact cylinder type	12 to 50	1474
BHA-LN	Cross roller parallel hand with sensor	12, 16, 20, 25	1478
BHG-LN	Cross roller parallel hand with sensor with rubber cover	12, 16, 20, 25	1478
BHE-LN	Centering hand with sensor	12, 16, 20, 25	1478

Hand/chuck ▶▶▶ Pneumatic Cylinders II - Hand: Page 1503 Chuck: Page 1771

Diverse variety is available, including thin, lightweight, and wide types. Compact/powerful. Diverse variety available



Listed Page P.1503 on

Parallel hand

Hand

Series	Also known as...	Bore size (ø)	Page
Parallel hand			
NEW LSH-HP1 LSHL-HP1	Linear Slide Hand (HP Series)	6 to 32	1506
NEW LSHM-HP2	Linear Slide Hand with length measuring function (HP Series)	10 to 25	1508
LSH	Linear Slide Hand (standard)	10 to 25	1581
FH100	Feather hand (Mini-parallel hand)	10 to 25	1590
BSA2	Miniature cross roller parallel hand	6	1596
BHA	Compact cross roller parallel hand	12 to 25	1600
BHG	Compact cross roller parallel hand with rubber cover	12 to 25	1606
LHA	Linear guide hand	6 to 32	1612
LHAG	Linear guide hand with rubber cover	12 to 32	1620
HAP-1C	Parallel hand	15	1628
HAP	Parallel hand	20 to 40	1630
HKP	Cross roller parallel hand	32 to 80	1636
HCP	Lateral parallel hand	12 to 32	1642
HGP	Long stroke parallel hand	25	1648
Thin parallel hand			
NEW HLF2	Long stroke thin hand	8x2 to 20x2	1652
HLA/HLB	Thin parallel hand	12 to 20	1662
HLAG/HLBG	Thin parallel hand with rubber cover	12 to 20	1670
HLC	Thin long stroke parallel hand	8x2 to 30x2	1678
HLD	Ultra thin parallel hand	8x4 to 20x4	1686
Wide parallel hand			
HMF	Compact wide parallel hand	12x2 to 40x2	1690
NEW HMF-G	Compact wide parallel hand with coolant specifications	16x2 to 25x2	1700
HMFB	Large wide parallel hand with linear guide	25x2 to 40x2	1708



Listed Page P.1503 on

Fulcrum hand/centering hand

Hand

Series	Also known as...	Bore size (ø)	Page
Fulcrum hand			
HFP	Wide parallel hand	16x2 to 40x2	1714
FH500	Feather hand (Mini-fulcrum hand)	10 to 20	1720
HBL	Fulcrum hand	15 to 40	1726
HJL	Toggle hand	32 to 63	1732
HMD	180 degree open/close thin wide angle hand	12 to 25	1738
HDL	180 degree open/close wide angle hand	25 to 40	1744
HJD	180 degree open/close high gripping wide angle hand	32 to 63	1748
Centering hand			
BHE	Centering hand	12 to 32	1752



Listed Page P.1771 on

Chuck

Series	Also known as...	Bore size (ø)	Page
3-way chuck			
CKL2	Powerful chuck	16 to 100	1774
CKLG2	Powerful chuck with rubber cover	20 to 100	1786
CKL2-HC	Position locking powerful chuck	32 to 80	1794
CKH2	Powerful chuck with high gripping force	50 to 100	1800
CKLB2	Bi-directional powerful chuck (parallel hand)	20 to 100	1806
CKG	3-way jaw bearing chuck	16 to 50	1814
CK	3-way jaw long stroke chuck	25 to 44	1820
CKA	3-way slim chuck	16 to 100	1826
CKS	Thin chuck	8x3 to 32x3	1834
NEW CKS-F	Slim chuck (hollow)	16x3 to 50x3	1844
CKF	Hollow chuck	30 to 80	1852
CKJ	Ultra long stroke chuck	12x6 to 50x6	1858
Auto hand changer			
CHC	Auto hand changer		1874



Listed Page P.1883 on

Mechanical hand/chuck

Series	Also known as...	Cylinder bore size (ø)	Page
BHA-FC	Mechanical hand	12 to 32	1884
CKL2-FC	Mechanical chuck	20 to 40	1886

Cylinders I: Standard, with valve, space saving, rodless

Cylinders II: Combined functions, with brake/position locking, high speed, special, oscillation/rotation drive, unit components, [length measurement function](#), [hand/chuck](#), [related products](#)

Related products ▶▶▶ Pneumatic Cylinders II - P.1889

Shock absorber/(absorbing capacity 1 to 720J)

3 models are available according to the application

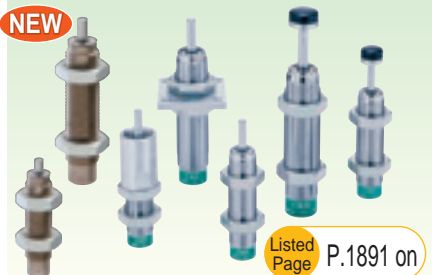

Shock absorber

SKL, NCK, SCK, FCK

Series	Also known as...	Absorbed energy	Page
Fixed			
SKL NEW	-	0.2 to 3.6	1894
NCK	-	1 to 200	1902
Adjustable			
SCK	-	0.049 to 588	1914
FCK-L	Low speed	1.5 to 79.3	1924
FCK-M	Medium speed		1924
FCK-H	High speed	1.8 to 720	1924

Absorbed energy: J

Free fitting/(size M3 to M45)

For preventing misalignment during cylinder mounting. 3 models available



Floating fitting

FJ

Series	Page
FJ	1948

Simplified floating connector

For preventing misalignment during cylinder mounting. Simplified.

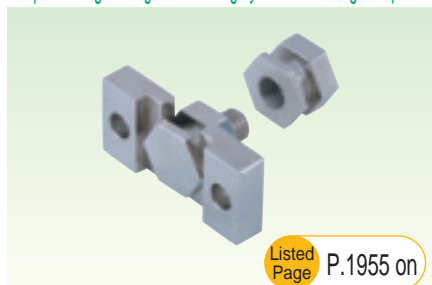

Simplified floating fitting

FK

Series	Page
FK	1956 NEW

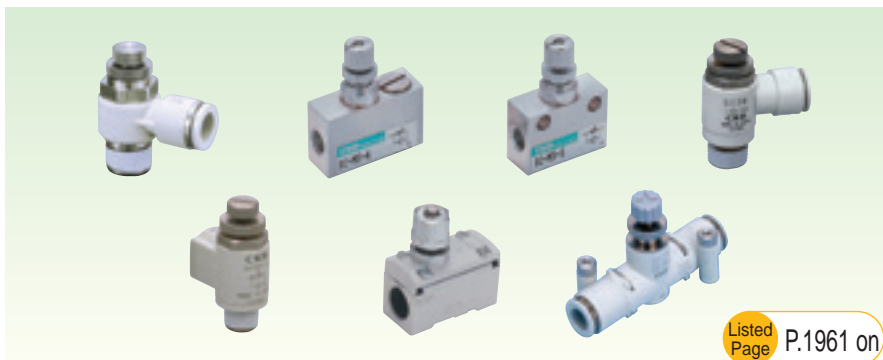

Speed controller

■ With dial

Series	Port size	Features	Page
DSC	M5, R1/8, 1/4, 3/8, 1/2	Enables easy control of cylinder speed values	1966

■ Needle valve with adjusting dial

Series	Port size	Features	Page
DVL	R1/8, 1/4, 3/8	Visible flow rate adjustment control achieved	1980

■ Elbow/push-in fitting

Series	Port size	Features	Page
SC3W	M3, M5, R1/8, 1/4, 3/8, 1/2	Push-in fitting \varnothing 3.2 to \varnothing 12	1988

■ Universal/push-in fitting

Series	Port size	Features	Page
SC3U	M3, M5, R1/8, 1/4, 3/8, 1/2	Push-in fitting \varnothing 3.2 to \varnothing 12	1992

■ Line type/with push-in fitting

Series	Port size	Features	Page
SCL2	\varnothing 1.8, \varnothing 4, \varnothing 6, \varnothing 8, \varnothing 10, \varnothing 12	Applicable to the remote centralized control of actuators	1998

■ In/out line type/with push-in fitting

Series	Port size	Features	Page
SCD2	\varnothing 1.8, \varnothing 4, \varnothing 6, \varnothing 8, \varnothing 10, \varnothing 12	Enables flow control for both air supply and exhaust	1998

■ Needle valve/line type with push-in fitting

Series	Port size	Features	Page
SCL2-N	\varnothing 4, \varnothing 6, \varnothing 8	Flow rate adjustment needle valve with non-scatter grease. Usable with clean-room special-oil-prohibited specs	2002

■ Stainless steel anti-corrosion

Series	Port size	Features	Page
SC3P	M5, R1/8, R1/4, R3/8, R1/2	Speed control valve with anti-corrosive stainless steel body	2008

■ Direct piping/elbow

Series	Port size	Features	Page
SC3R	M5, Rc1/8, 1/4, 3/8, 1/2	Direct piping, L-shape rotation M5 to Rc1/2	2012

■ Miniature

Series	Port size	Features	Page
SC	M3, M5	Compact, lightweight, and space saving	2014

■ Miniature fine speed

Series	Port size	Features	Page
SC-M5*-F	M5	For fine speed adjustment of fine speed cylinder and air operated valve	2014

■ Miniature in/out

Series	Port size	Features	Page
SCD	M3, M5	Enables flow control for both air intake and exhaust	2016

■ Medium bore size

Series	Port size	Features	Page
SC1	Rc1/8, 1/4, 3/8, 1/2	Applicable to general medium bore sizes	2020

■ Large bore size

Series	Port size	Features	Page
SC	Rc3/4, 1, 1 1/4, 1 1/2, 2	Applicable to general large bore sizes	2022

■ Outdoor Series

Series	Port size	Features	Page
SC1-W	Rc1/4, 3/8, 1/2	Applicable for outdoor use	2024

Guide to model changes

The series listed in this catalog have undergone a model changeover with these new series. Consider these new series when making selections.

■ Rodless cylinder

SRL2

Old series



■ Rodless cylinder

SRL3

New series



■ High precision guided rodless cylinder

SRG

Old series

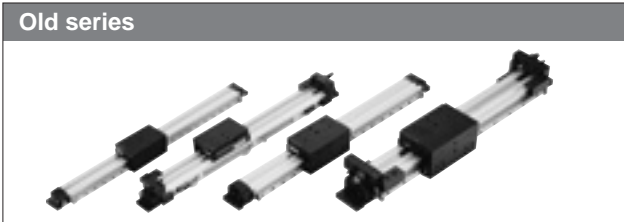

■ High precision guided rodless cylinder

SRG3

New series

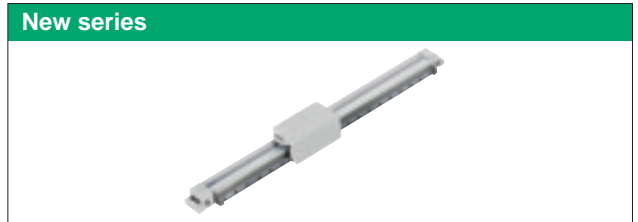

SRM

Old series



SRM3

New series



■ Rodless cylinder with brake

SRT

Old series



■ Rodless cylinder with brake

SRT3

New series

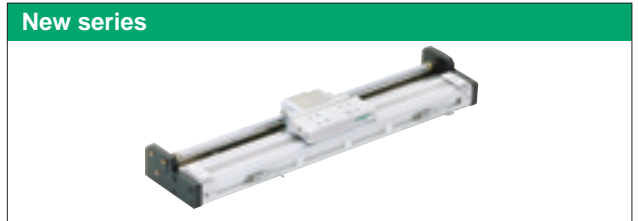

■ Clamp cylinder

CAC3

Old series

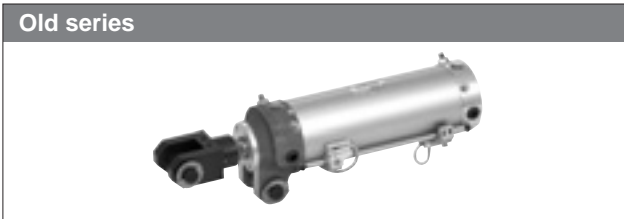

■ Clamp cylinder

CAC4

New series



■ Position locking clamp cylinder

UCAC

Old series



■ Position locking clamp cylinder

UCAC2

New series

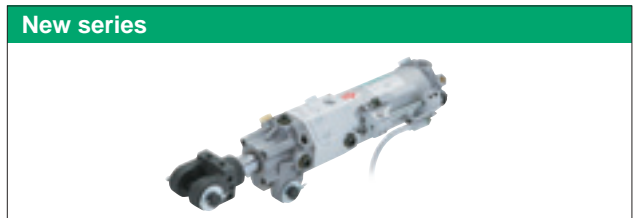

■ Linear slide cylinder

LCS

Old series



■ Linear slide cylinder

LCR

New series

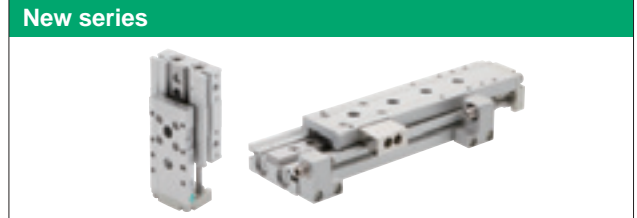

■ Pencil shaped cylinder

SCP*2

Old series

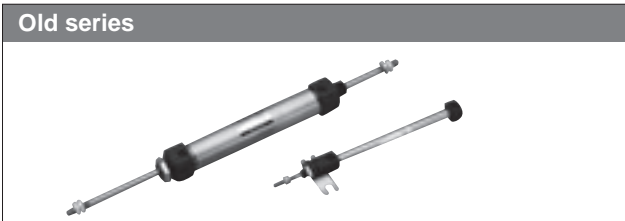

■ Pencil shaped cylinder

SCP*3

New series

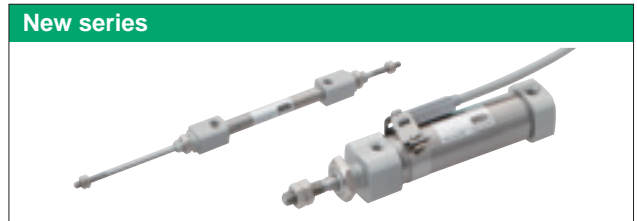

■ Large bore size cylinder

SCS

Old series

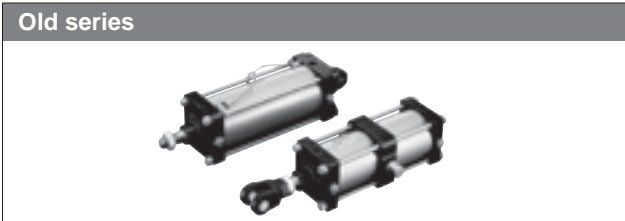

■ Large bore size cylinder

SCS2

New series



■ Brake cylinder (large bore size)

JSC3

Old series

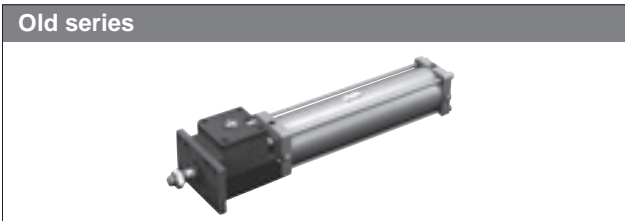

■ Brake cylinder (large bore size)

JSC4

New series

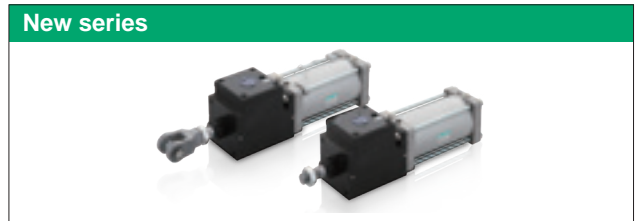

■ Compact cylinder

SMD2

Old series

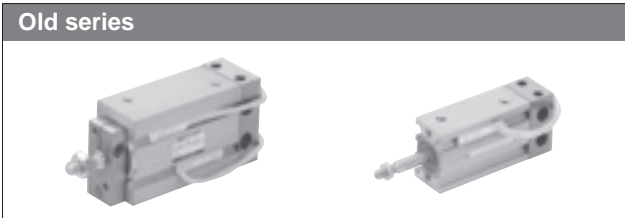

■ Compact cylinder

SMG

New series

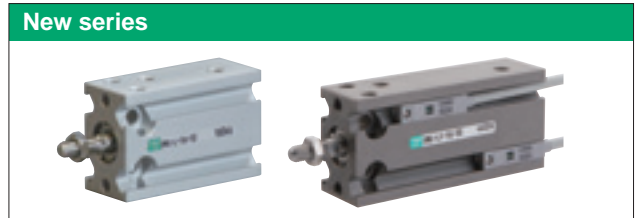

■ Rotary clamp cylinder

RCS

Old series



■ Rotary clamp cylinder

RCS2

New series



Guide to CKD's CAD data

How to use CKD's CAD data

CKD's CAD data is provided as follows for your use in CAD design.

2D CAD data



Types of compatible CAD

- DXF
- Dedicated CAD types

3D CAD data

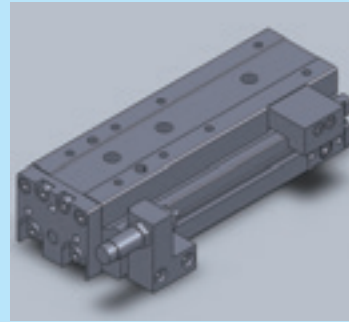

Types of compatible CAD

- DXF
- IGES
- SAT
- Parasolid
- Dedicated CAD types

Homepage

Catalog PDFs and CAD data of CKD products are available for download.



<https://www.ckd.co.jp/en/>

For PDF and DXF data of the general catalogs

CKD Website
Component Products

>

Materials: Download digital
catalogs/catalog PDFs

For PDF and DXF data of new products

CKD Website
Component Products

>

Search for a product
from the product list

For 2D/3D CAD data

CKD Website
Component Products

>

Materials: Download 2D
CAD data/3D CAD data

Guide to the model selection system

How to use the model selection system

The CKD system supports selection of the following items.
For your use during model selection and design.

Available on our website

This system is used to select products according to your application and working conditions.



*Downloading Software may not be possible due to your security settings. If that is the case, contact CKD.

Selection results are linked with catalog PDFs and CAD data!

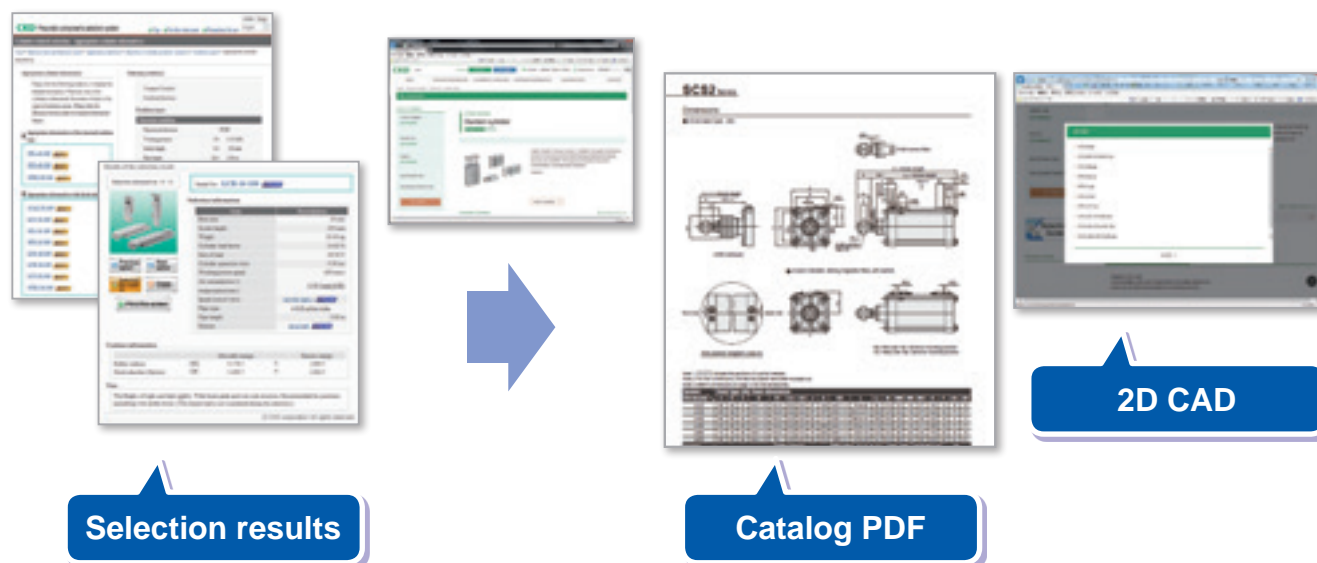

Registration not required - available at any time!

A variety of services such as CKD product catalogs, PDFs, CAD data, and model selection are available.
Feel free to try them.

<https://www.ckd.co.jp/en/>

3 Search by bore size

Series name	Variation	Switch						
			2.5	4	6	8	10	
Pencil shaped cylinder ● Contents/page 3, series variation/ page 4	SCPS (single acting/push)	Not available	●	●				
	SCPS3 (single acting/push)	Available			●		●	
	SCPH3 (single acting/pull)	Available			●		●	
	SCPD3 (double acting/single rod)	Available			●		●	
	SCPD3-F (double acting/fine speed)	Available			●		●	
	SCPD3-O (double acting/low speed)	Available			●		●	
	SCPD3-*C (double acting/rubber-air cushioned)	Available			●		●	
	SCPD3-T (double acting/heat resistance)	Not available			●		●	
	SCPD3-D (double acting/double rod)	Available			●		●	
	SCPD3-D T (double acting/double rod/heat resistance)	Not available			●		●	
	SCPD3-Z (double acting/with speed controller)	Available					●	
	SCPS3-M (single acting/push/rotation-stop)	Available					●	
	SCPD3-M (double acting/rotation-stop)	Available					●	
	SCPD3-K (double acting/high load)	Available			●		●	
	SCPS3-V (single acting/with valve)	Available					●	
SCPD3-V (double acting/with valve)	Available					●		
Small bore size cylinder ● Contents/P81, Series variation/ P82	CMK2 (double acting/single rod)	Available						
	CMK2-S (single acting/push)	Available						
	CMK2-SR (single acting/pull)	Available						
	CMK2-D (double acting/double rod)	Available						
	CMK2-B (double acting/back to back)	Available						
	CMK2-F (double acting/fine speed)	Available						
	CMK2-P (double acting/stroke adjustable/push)	Available						
	CMK2-R (double acting/stroke adjustable/pull)	Available						
	CMK2-M (double acting/rotation-stop)	Available						
	CMK2-C (double acting/air cushioned)	Available						
	CMK2-*C (double acting/rubber-air cushioned)	Available						
	CMK2-Z (double acting/integrated speed controller)	Available						
	CMK2-H (double acting/low hydraulic)	Available						
	CMK2-T (double acting/heat resistance)	Not available						
	CMK2-Q (double acting/position locking)	Available						
	CMK2- $\frac{G_2}{G_3}$ (double acting/coolant proof)	Available						
CMK2-J $\frac{G_2}{G_3}$ (Double acting/Stainless steel)	Available							
Medium bore size cylinder ● Contents/P205/Series variation/P206	CMA2 (double acting/single rod)	Available						
	CMA2-E (double acting/direct mounting)	Available						
Round shaped Cylinder ● Contents/P227/series variation/ P228	SCM (double acting/single rod)	Available						
	SCM-X (single acting/push)	Available						
	SCM-Y (single acting/pull)	Available						
	SCM-D (double acting/double rod)	Available						
	SCM-B (double acting/back to back)	Available						
	SCM-W (double acting/2-stage)	Available						
	SCM-W4 (double acting/tandem)	Available						
	SCM-P (double acting/stroke adjustable/push)	Available						
	SCM-R (double acting/stroke adjustable/pull)	Available						
	SCM-M (double acting/rotation-stop)	Available						
	SCM-LD (double acting/direct mounting foot)	Available						
	SCM-F (double acting/fine speed)	Available						

Bore size (ø)																				Page	
12	15	16	20	25	30	32	40	50	63	75	80	100	125	140	160	180	200	250			
		●																		I-16	
		●																			I-16
		●																			I-16
		●																			I-8
		●																			I-34
		●																			I-40
		●																			I-28
		●																			I-26
		●																			I-44
		●																			I-44
		●																			I-50
		●																			I-56
		●																			I-56
		●																			I-64
		●																			I-70
		●																			I-70
			●	●			●	●													I-86
			●	●			●	●													I-100
			●	●			●	●													I-106
			●	●			●	●													I-154
			●	●			●	●													I-160
			●	●			●	●													I-148
			●	●			●	●													I-112
			●	●			●	●													I-118
			●	●			●	●													I-166
			●	●			●	●													I-136
			●	●			●	●													I-128
			●	●			●	●													I-172
			●	●			●	●													I-178
			●	●			●	●													I-124
			●	●			●	●													I-142
			●	●			●	●													I-182
			●	●			●	●													I-188
			●		●			●													I-208
			●		●			●													I-222
			●	●			●	●	●	●		●	●								I-232
			●	●			●	●													I-254
			●	●			●	●													I-260
			●	●			●	●	●	●		●	●								I-308
			●	●			●	●	●	●											I-316
			●	●			●	●	●	●											I-322
			●	●			●	●	●	●											I-328
			●	●			●	●	●	●											I-266
			●	●			●	●	●	●											I-272
			●	●			●	●	●	●											I-334
			●	●			●	●	●	●											I-340
			●	●			●	●													I-292

3 Search by bore size

Series name	Variation	Switch						
			2.5	4	6	8	10	
Round shaped cylinder ● Contents/p227/series variation/ p228	SCM-O (double acting/low speed)	Available						
	SCM-U (double acting/low friction)	Available						
	SCM-T (double acting/heat resistance)	Not available						
	SCM-Q (double acting/position locking)	Available						
Tie rod cylinder ● Contents/p351/series variation/ p354	SCG (double acting/single rod)	Available						
	SCG-Q (double acting/Position locking)	Available						
	SCG-O (double acting/Low speed)	Available						
	SCG-U (double acting/Low friction)	Available						
	SCG-D (double acting/Double rod)	Available						
	SCG-M (double acting/rotation-stop)	Available						
	SCG-G (double acting/heavy duty scraper)	Available						
	SCG-G2,G3 (Double acting/Coolant proof)	Available						
SCG-G4 (double acting/anti-spatter adherence)	Available							
Medium bore size cylinder ● ItemNext/p443/Series variation/ p444	SCA2 (double acting/single rod)	Available						
	SCA2-D (double acting/double rod)	Available						
	SCA2-B (double acting/back to back)	Available						
	SCA2-W (double acting/2-stage)	Available						
	SCA2-P (double acting/stroke adjustable/push)	Available						
	SCA2-R (double acting/stroke adjustable/pull)	Available						
	SCA2-K (double acting/steel tube)	Not available						
	SCA2-H (double acting/low hydraulic)	Available						
	SCA2-T (double acting/heat resistance)	Available						
	SCA2-O (double acting/low friction)	Available						
	SCA2-U (double acting/low friction)	Available						
	SCA2-G (double acting/rubber scraper)	Available						
	SCA2-Q2 (double acting/position locking)	Available						
	SCA2-V (double acting/with valve)	Available						
SCA2- $\frac{G2}{G3}$ (double acting/coolant proof)	Available							
SCA2- $\frac{G1}{G4}$ (double acting/coil scraper/anti-spatter adherence)	Available							
Medium bore size cylinder ● Contents/p621/series variation/ p622	SCS2 (double acting/single rod/lubrication)	Not available						
	SCS2-N (double acting/single rod/no-lubrication)	Available						
	SCS2-D (double acting/double rod)	Available						
	SCS2-ND (double acting/double rod/no-lubrication)	Available						
	SCS2-B (double acting/back to back)	Not available						
	SCS2-W (double acting/2-stage)	Not available						
	SCS2-P (double acting/stroke adjustable)	Not available						
	SCS2-H (double acting/low hydraulic)	Available						
	SCS2-T (double acting/heat resistance)	Not available						
SCS2-G (double acting/rubber scraper)	Not available							
Compact cylinder with valve ● Index/p675, series variation/p674	CKV2 (double acting/single rod/with valve)	Available						
	CKV2-M (double acting/rotation-stop/with valve)	Available						

Bore size(ø)																			Page
12	15	16	20	25	30	32	40	50	63	75	80	100	125	140	160	180	200	250	
			●	●		●	●	●	●		●								I-298
			●	●		●	●	●	●		●	●							I-302
			●	●		●	●	●	●		●	●							I-278
			●	●		●	●	●	●		●	●							I-282
						●	●	●	●		●	●							I-358
						●	●	●	●		●	●							I-374
						●	●	●	●		●	●							I-396
						●	●	●	●		●	●							I-402
						●	●	●	●		●	●							I-406
						●	●	●	●		●	●							I-412
						●	●	●	●		●	●							I-418
							●	●	●		●	●							I-424
						●	●	●	●		●	●							I-430
							●	●	●		●	●							I-450
							●	●	●		●	●							I-540
							●	●	●		●	●							I-548
							●	●	●		●	●							I-556
							●	●	●		●	●							I-472
							●	●	●		●	●							I-480
							●	●	●		●	●							I-564
							●	●	●		●	●							I-568
							●	●	●		●	●							I-488
							●	●	●		●	●							I-526
							●	●	●		●	●							I-534
							●	●	●		●	●							I-576
							●	●	●		●	●							I-494
							●	●	●		●	●							I-596
							●	●	●		●	●							I-584
							●	●	●		●	●							I-590
														●	●	●	●	●	I-626
														●	●	●	●	●	I-626
														●	●	●	●	●	I-648
														●	●	●	●	●	I-648
														●	●	●	●	●	I-654
														●	●	●	●	●	I-658
														●	●	●	●	●	I-640
														●	●	●	●	●	I-662
														●	●	●	●	●	I-644
														●	●	●	●	●	I-668
			●	●		●	●												I-680
			●	●		●	●												I-692

3 Search by bore size

Series name	Variation	Switch						
			2.5	4	6	8	10	
Cylinder with valve Short total length with cushion ● Contents/p703/series variation/p704	CAV2-S (double acting/double solenoid/lubrication)	Available						
	COVP2-S (double acting/single solenoid/pushed out when energized/lubrication)	Available						
	COVN2-S (double acting/single solenoid/retracted in when energized/lubrication)	Available						
	CAV2-NS (double acting/double solenoid/no-lubrication)	Available						
	COVP2-NS (double acting/single solenoid/pushed out when energized/no-lubrication)	Available						
	COVN2-NS (double acting/single solenoid/retracted in when energized/no-lubrication)	Available						
Super compact cylinder ● Contents/P745/Series variation/P748	SSD2 (double acting/single rod)	Available						
	SSD2-K (double acting/high load)	Available						
	SSD2-L (double acting/long stroke)	Available						
	SSD2-X (single acting/push)	Available						
	SSD2-Y (single acting/pull)	Available						
	SSD2-T1 (double acting/heat resistance)	Not available						
	SSD2-T1L (double acting/with heat resistant cylinder switch)	Available						
	SSD2-K* ^C (double acting/high load/rubber-air cushioned)	Available						
	SSD2-Q (double acting/position locking)	Available						
	SSD2-F (double acting/fine speed)	Available						
	SSD2-KF (double acting/high load/fine speed)	Available						
	SSD2-O (double acting/low speed)	Available						
	SSD2-KU (double acting/high load/low friction)	Available						
	SSD2-D (double acting/double rod)	Available						
	SSD2-B (double acting/back to back)	Available						
	SSD2-W (double acting/2-stage)	Available						
	SSD2-M (double acting/rotation-stop)	Available						
	SSD2-DM (double acting/double rod/rotation-stop)	Available						
	SSD2-G (double acting/rubber scraper)	Available						
	SSD2- ^{G2} / _{G3} (Double acting/coolant proof)	Available						
	SSD2- ^{KG2} / _{KG3} (double acting/high load/coolant proof)	Available						
	SSD2-G1 (double acting/coil scraper)	Available						
	SSD2-G4 (double acting/anti-spatter adherence)	Available						
	SSD2-KG1 (double acting/high load/coil scraper)	Available						
	SSD2-KG4 (double acting/high load/anti-spatter adherence)	Available						
	SSD2-DG1 (double acting/double rod/coil scraper)	Available						
	SSD2-DG4 (double acting/double rod/anti-spatter adherence)	Available						
	SSD2-G5 (double acting/environment-resistant scraper)	Available						
	SSD2-KG5 (double acting/high load/environment-resistant scraper)	Available						
	SSD2-L4 (double acting/with strong magnetic field proof switch)	Available						
	SSD2-G1L4 (double acting/with strong magnetic field proof switch/with coil scraper)	Available						
	SSD2-KL4 (double acting/high load/with strong magnetic field proof switch)	Available						
	SSD2-KG1L4 (double acting/high load/with strong magnetic field proof switch/with coil scraper)	Available						
SSD2-P7* (double acting/clean-room specifications)	Available							
Guided super Compact cylinder ● Contents/P1065/Series variation/P1067	SSG (double acting/single rod)	Available						

3 Search by bore size

Series name	Variation	Switch							
			2.5	4	6	8	10		
Super compact cylinder ● Contents/p1081/series variation/p1082	SSD (double acting/single rod)	Available							
	SSD-X (single acting/push)	Available							
	SSD-Y (single acting/pull)	Available							
	SSD-D (double acting/double rod)	Available							
	SSD-B (double acting/back to back)	Available							
	SSD-W (double acting/2-stage)	Available							
	SSD-K (double acting/single rod/high load)	Available							
	SSD-K-*C (double acting/high load/rubber-air cush-)	Available							
	SSD-T (double acting/heat resistance)	Not available							
	SSD-T1L (double acting/with heat resistant cylinder switch)	Available							
	SSD-F (double acting/fine speed)	Available							
	SSD-KF (double acting/high load/fine speed)	Available							
	SSD-O (double acting/low speed)	Available							
	SSD-M (double acting/rotation-stop)	Available							
	SSD-KU (double acting/high load/low friction)	Available							
	SSD-Q (double acting/position locking)	Available							
	SSD- ^{G2} / _{G3} (double acting/coolant proof)	Available							
	SSD- ^{KG2} / _{KG3} (double acting/high load/coolant proof)	Available							
	SSD- ^{G1} / _{G4} (double acting/anti-spatter adherence)	Available							
	SSD- ^{KG1} / _{KG4} (double acting/high load/anti-spatter adherence)	Available							
SSD- ^{DG1} / _{DG4} (double acting/double rod/anti-spatter adherence)	Available								
SSD- G5 (double acting/Environment-resistant scraper)	Available								
SSD- KG5 (double acting/high load/Environment-resistant scraper)	Available								
Cartridge cylinder ● Contents/p1339/series variation/p1339	CAT (single acting/push)	Not available			●			●	
Compact direct mounting cylinder ● Contents/p1345/series variation/p1346	MDC2 (double acting/single rod)	Available		●	●	●	●		
	MDC2-X (single acting/push)	Available		●	●	●	●		
	MDC2-Y (single acting/pull)	Available		●	●	●	●		
	MDC2-F (double acting/fine speed)	Available			●	●	●		
Compact cylinder with suction pad ● Contents/p1371/series variation/p1373	MVC (double acting/single rod)	Available			●			●	
Compact cylinder ● Contents/P1383/Series variation/P1385	SMG (double acting/single rod)	Available			●			●	
	SMG-X (single acting/push)	Available			●			●	
	SMG-Y (single acting/pull)	Available			●			●	
	SMG-F (double acting/fine speed)	Available			●			●	
	SMG-M (double acting/rotation-stop)	Available			●			●	
Small compact cylinder ● Contents/p1415/series variation/p1418	MSD (double acting/single rod)	Available			●	●			
	MSD-X (single acting/push)	Available			●	●			
	MSD-Y (single acting/pull)	Available			●	●			
	MSD-K (double acting/high load)	Available			●	●			
	MSDG-L (double acting/guided)	Available			●	●			
	MSD-F (double acting/fine speed)	Available			●	●			
	MSD-KF (double acting/high load/fine speed)	Available			●	●			
	MSDG-LF (double acting/guided/high load)	Available			●	●			

Bore size (ø)																			Page
12	15	16	20	25	30	32	40	50	63	75	80	100	125	140	160	180	200	250	
		●	●	●		●	●	●	●		●	●	●	●	●				I-1094
●		●	●	●		●	●	●											I-1126
●		●	●	●		●	●	●											I-1126
●		●	●	●		●	●	●	●		●	●	●	●	●				I-1188
●		●	●	●		●	●	●	●		●	●							I-1200
●		●	●	●		●	●	●	●		●	●							I-1210
●		●	●	●		●	●	●	●		●	●							I-1116
		●	●	●		●	●	●	●		●	●							I-1150
		●	●	●		●	●	●	●		●	●							I-1138
		●	●	●		●	●	●	●		●	●							I-1142
●		●	●	●		●	●	●	●		●	●							I-1172
●		●	●	●		●	●	●	●		●	●							I-1172
●		●	●	●		●	●	●	●		●	●							I-1178
●		●	●	●		●	●	●	●		●	●							I-1220
●			●	●		●	●	●	●		●	●							I-1184
		●																	I-1160
		●	●	●		●	●	●	●		●	●							I-1230
		●	●	●		●	●	●	●		●	●							I-1238
						●	●	●	●		●	●							I-1246
						●	●	●	●		●	●							I-1254
						●	●	●	●		●	●							I-1264
			●	●		●	●	●	●		●	●							I-1272
			●	●		●	●	●	●		●	●							I-1280
	●																		I-1340
																			I-1348
																			I-1354
																			I-1354
																			I-1364
																			I-1374
		●	●	●		●													I-1386
		●	●	●		●													I-1392
		●	●	●		●													I-1392
		●	●	●		●													I-1400
		●	●	●		●													I-1404
																			I-1422
																			I-1430
																			I-1430
●		●																	I-1440
●		●																	I-1452
●		●																	I-1450
●		●																	I-1450
●		●																	I-1462

3 Search by bore size

Series name	Variation	Switch							
			2.5	4	4.5	6	8	10	
Flat cylinder compact demi ● Contents/p1473/series variation/p1474	FCS (single acting/push)	Available							
	FCH (single acting/pull)	Available							
	FCD (double acting/single rod)	Available							
	FCD-D (double acting/double rod)	Available							
	FCD-K (double acting/cushioned)	Available							
Stopper cylinder ● Contents/p1509/series variation/p1510	STK (double acting/round rod end)	Available							
	STK-Y (single acting/retracted in when energized/round rod end)	Available							
	STK-Y1 (double acting/with spring/round rod end)	Available							
	STK-M (double acting/rod end chamfered type)	Available							
	STK-MY (single acting/pull/rod end chamfered type)	Available							
	STK-MY1 (double acting/with spring/rod end chamfered type)	Available							
	STK-JY (single acting/retracted in when energized/rod end roller)	Available							
	STK-JY1 (double acting/with spring/rod end roller)	Available							
Rodless cylinder ● Contents/p1569/series variation/p1570	SRL3 (double acting)	Available							
	SRL3-G (double acting/with resin guide)	Available							
	SRL3-Q (double acting/position locking)	Available							
	SRL3-GQ (double acting/with resin guide/position locking)	Available							
High precision guided rodless cylinder ● Contents/p1645/series variation/p1646	SRG3 (double acting)	Available							
High precision guided rodless cylinder ● Contents/p1673/series variation/p1674	SRM3 (double acting)	Available							
	SRM3-Q (double acting/position locking)	Available							
Rodless cylinder with brake ● Contents/p1703/series variation/p1704	SRT3 (double acting)	Available							
Magnet rodless cylinder ● Contents/p1731/series variation/p1736	MRL2 (double acting/basic)	Available				●		●	
	MRL2-G (simplified guide 1-piston)	Available				●		●	
	MRL2-W (simplified guide 2-piston)	Available				●		●	
	MRL2-F (double acting/Basic type/fine speed)	Available				●		●	
	MRL2-GF (simplified guide 1-piston/fine speed)	Available				●		●	
	MRL2-WF (simplified guide 2-piston/fine speed)	Available				●		●	
Magnet rodless cylinder With high precision guide ● Contents/p1763/series variation/p1765	MRG2 (double acting)	Available						●	
Shuttle mover ● Contents/p1783	SM-25	Not available							
Linear slide cylinder ● Contents/page 5, series variation/page 8	LCM (double acting/single rod)	Available			●	●	●		
	LCM-P (double acting/stroke adjustable/push)	Available			●	●	●		
	LCM-R (double acting/stroke adjustable/pull)	Available			●	●	●		
	LCM-A (double acting/side mounting)	Available			●	●	●		
Linear slide cylinder ● Contents/page 53, series variation/page 56	LCR (double acting/single rod)	Available				●	●		
	LCR-Q (double acting/position locking)	Available					●		
	LCR-F (double acting/single rod/fine speed)	Available							

Bore size (ø)																				Page
12	15	16	20	25	30	32	40	50	63	75	80	100	125	140	160	180	200	250		
				●		●	●	●	●											I-1480
				●		●	●	●	●											I-1480
				●		●	●	●	●											I-1488
				●		●	●	●	●											I-1494
				●		●	●	●	●											I-1500
			●			●	●	●												I-1512
			●			●	●	●												I-1518
			●			●	●	●												I-1524
			●			●	●	●												I-1530
			●			●	●	●												I-1536
			●			●	●	●												I-1542
			●			●	●	●												I-1548
			●			●	●	●												I-1554
●		●	●	●		●	●	●	●		●	●								I-1574
●		●	●	●		●	●	●	●		●	●								I-1590
●		●	●	●		●	●	●	●		●	●								I-1604
●		●	●	●		●	●	●	●		●	●								I-1614
●		●	●	●																I-1650
				●		●	●		●											I-1676
				●		●	●		●											I-1676
●		●	●	●		●	●	●	●											I-1706
		●	●	●		●														I-1740
		●	●	●		●														I-1740
		●	●	●		●														I-1740
		●	●	●		●														I-1740
		●	●	●		●														I-1740
		●		●																I-1740
				●																I-1766
				●																I-1784
																				II-10
																				II-18
																				II-24
																				II-30
●		●	●	●																II-58
●		●	●	●																II-84
●		●	●	●																II-112

3 Search by bore size

Series name	Variation	Switch						
			2.5	4	6	8	10	
Linear slide cylinder ● Contents/p135/series variation/p138	LCG (double acting/single rod)	Available			●	●		
	LCG-Q (double acting/position locking)	Available				●		
Linear slide cylinder ● Contents/p199/series variation/p202	LCW (double acting/single rod)	Available						
	LCW-Q (double acting/position locking)	Available						
Linear slide cylinder ● Contents/p249/series variation/p252	LCX (double acting/single rod)	Available						
	LCX-Q (double acting/position locking)	Available						
	LCX-P7* (double acting/clean-room specifications)	Available						
	LCX-*L (double acting/long stroke)	Available						
	LCX-Q-*L (double acting/position locking/long stroke)	Available						
	LCX-*L-P7* (double acting/clean-room specifications/long stroke)	Available						
Guided cylinder ● Contents/p309/series variation/p310	STM-M/B (double acting/single rod)	Available			●		●	
	STM-M/B -P7* (double acting/clean-room specifications)	Available			●		●	
Guided cylinder ● Contents/p329/series variation/p332	STG- ^M _B (double acting/single rod)	Available						
	STG- ^M _B -*C (double acting/rubber-air cushioned)	Available						
	STG- ^M _B C (double acting/air cushioned)	Available						
	STG- ^M _B Q (double acting/position locking)	Available						
	STG- ^M _B G, G1 (double acting/rubber scraper/coil scraper)	Available						
	STG- ^M _B G2, G3 (double acting/coolant proof)	Available						
	STG- ^M _B G4 (double acting/anti-spatter adherence)	Available						
	STG-MG5 (double acting/environment-resistant scraper)	Available						
Guided cylinder ● Contents/p441/series variation/p442	ST ^S _L - ^M _B (double acting/single rod)	Available			●			
	ST ^S _L - ^M _B F (double acting/fine speed)	Available			●			
	ST ^S _L - ^M _B O (double acting/low speed)	Available			●			
	ST ^S _L - ^{MG} _{MG1} (double acting/scraper)	Available						
	ST ^S _L - ^M _B T (double acting/heat resistance)	Not available						
	ST ^S _L - ^M _B T2 (double acting/packing material fluoro rubber)	Available						
	ST ^S _L - ^M _B P (double acting/stroke adjustable/push)	Available			●			
	ST ^S _L - ^M _B Q (double acting/position locking)	Available						
	ST ^S _L - ^M _B V (double acting/valve equipped)	Available						
	ST ^S _L - ^M _B C (double acting/air cushioned)	Available						
	ST ^S _L - ^M _B -*C (double acting/rubber-air cushioned)	Available						
	ST ^S _L - ^{MG} _{BG3} (double acting/coolant proof)	Available						
	ST ^S _L - ^{MG} _{BG4} (double acting/anti-spatter adherence)	Available						
	Twin rod cylinder ● Contents/p575/series variation/p576	STR2- ^M _B (Double acting/single rod)	Available			●		●
STR2- ^M _B F (double acting/fine speed)		Available					●	
STR2- ^M _B O (double acting/low speed)		Available			●		●	
STR2- ^M _B D (double acting/double rod)		Available			●		●	
STR2- ^M _B Q (double acting/position locking)		Available						
Unit cylinder ● Contents/p635/series variation/p636	UCA2 (double acting/single rod/metal bush bearing)	Available					●	
	UCA2-B (double acting/single rod/ball bearing)	Available					●	

Bore size (ø)																			Page	
12	15	16	20	25	30	32	40	50	63	75	80	100	125	140	160	180	200	250		
					●		●													II-206
					●		●													II-216
					●		●													II-222
					●		●													II-228
					●		●													II-238
					●		●													II-244
																				II-314
																				II-320
	●		●	●	●		●	●	●	●		●								II-336
							●	●	●	●										II-350
			●	●	●		●	●	●	●										II-358
				●	●		●	●	●	●										II-368
				●	●		●	●	●	●										II-376
				●	●		●	●	●	●										II-382
								●	●	●										II-388
				●	●		●	●	●	●		●	●							II-394
	●		●	●	●		●	●	●	●		●	●							II-444
	●		●	●	●		●	●	●	●		●								II-466
	●		●	●	●		●	●	●	●		●								II-472
				●	●		●	●	●	●		●								II-476
	●		●	●	●		●	●	●	●		●								II-482
	●		●	●	●		●	●	●	●		●								II-488
	●		●	●	●		●	●	●	●		●								II-496
				●	●		●	●	●	●		●								II-508
				●	●		●	●	●	●		●								II-510
					●		●	●	●	●		●								II-514
							●	●	●	●		●								II-522
				●	●		●	●	●	●		●								II-532
								●	●	●		●								II-540
			●	●	●		●													II-572
			●	●	●		●													II-584
			●	●	●		●													II-594
			●	●	●		●													II-602
			●	●	●		●													II-604
			●	●	●		●													II-630
			●	●	●		●													II-640

3 Search by bore size

Series name	Variation	Switch						
			2.5	4	4.5	6	8	10
Brake cylinder ● Contents/p671/series variation/p672	ULKP (double acting)	Available						
	ULK (double acting/single rod)	Available						
	ULK-V (double acting/with valve)	Available						
Brake cylinder small bore size/crimping ● Contents/p701/series variation/p702	JSK2 (double acting/single rod)	Available						
	JSK2-V (double acting/with valve)	Available						
Brake cylinder small bore size/disassembling ● Contents/p701/series variation/p702	JSM2 (double acting/single rod)	Available						
	JSM2-V (double acting/with valve)	Available						
Tie rod cylinder with brake ● Contents/p737/series variation/p740	JSG (double acting/single rod)	Available						
	JSG-V (double acting/with valve for brake release)	Available						
Brake cylinder medium and large bore size ● Contents/p767/series variation/p768	JSC3 (-S)/JSC4 (double acting/single rod/low pressure release)	Available						
	JSC3-V (S) (double acting/with valve for brake/low pressure release)	Available						
	JSC3-H(S)/JSC4-H (double acting/low hydraulic/low pressure release)	Available						
	JSC3-T(S)/JSC4-T (double acting/heat resistance/low pressure release)	Not available						
Position locking compact cylinder ● Contents/p841/series variation/p844	USSD (double acting/single rod)	Available						
	USSD-K (double acting/single rod/high load)	Available						
Free position locking flat cylinder ● Contents/p885/series variation/p887	UFDC-KL(double acting/single rod/cushioned)	Available						
Free position locking medium bore size cylinders ● Contents/p901/series variation/p902	USC (double acting/single rod)	Available						
	USC-G1 (double acting/with coil scraper)	Available						
High energy absorption cylinder ● Contents/p957/series variation/p958	HCM (double acting)	Available						
High speed cylinder ● Contents/p975/series variation/p976	HCA (double acting/single rod)	Available						
Clamp cylinder ● Contents/p1005/series variation/p1006	CAC4 (double acting/single rod)	Available						
	CAC4-G4 (double acting/anti-spatter adherence)	Available						
Position locking clamp cylinder ● Contents/p1029/series variation/p1029	UCAC2 (double acting)	Available						
Lightweight clamp cylinder ● Contents/p1043/series variation/p1045	CAC-N (double acting/single rod)	Available						
Position locking and lightweight clamp cylinder ● Contents/p1043/series variation/p1045	UCAC-N (double acting/single rod)	Available						
Rotary clamp cylinder ● Contents/p1063/series variation/p1066	RCS2 (double acting/single rod)	Available						
	RCS2-T2 (double acting/Packing material fluoro rubber)	Available						
	RCS2-G4 (double acting/Anti-spatter adherence)	Available						
Rotary clamp cylinder ● Contents/p1095/series variation/p1095	RCC2 (double acting/single rod)	Available						
	RCC2-G4 (double acting/anti-spatter adherence)	Available						
Pin clamp cylinder ● Contents/p1117	PCC (double acting/single rod)	Available						
	PCC-Q (double acting/position locking)	Available						
High power cylinder ● Contents/p1137/series variation/p1142	SHC (double acting/double force)	Available						
	SHC-K (double acting/quadruple force)	Available						
Guideless cylinder ● Contents/p1193/series variation/p1196	GLC (double acting)	Available						
Robot cylinder ● Contents/p1213/series variation/p1214	MFC (double acting/single rod)	Available						
	MFC-K (double acting/high load)	Available						
	MFC-B (double acting/with brake)	Available						
	MFC-BK (double acting/with brake/high load)	Available						
	MFC-BS (double acting/with brake sensor)	Not available						
	MFC-BSK (double acting/with brake sensor/high load)	Not available						
Balancer unit ● Contents/p1253/series variation/p1256	BBS-A (auto pressure adjustment)	Available						
	BBS-O (fixed pressure adjustment)	Available						

Bore size (ø)																			Page
12	15	16	20	25	30	32	40	50	63	75	80	100	125	140	160	180	200	250	
		●																	II-674
			●	●			●	●											II-680
			●	●			●	●											II-680
			●	●			●	●											II-706
			●	●			●	●											II-706
			●			●		●											II-720
			●			●		●											II-720
								●	●			●	●						II-742
								●	●			●	●						II-742
								●	●			●	●	●	●	●	●		II-774
								●	●			●	●						II-810
								●	●			●	●	●	●	●	●		II-818
								●	●			●	●	●	●	●	●		II-830
				●	●			●	●	●	●	●	●						II-846
				●	●			●	●	●	●	●	●						II-846
					●			●	●	●	●								II-888
								●	●	●		●	●						II-904
								●	●	●		●	●						II-904
				●	●			●	●	●	●								II-960
				●	●			●	●	●	●		●	●					II-978
								●	●	●		●							II-1008
								●	●	●		●							II-1020
									●	●									II-1030
								●	●										II-1046
								●	●										II-1052
	●			●	●			●	●	●	●								II-1068
	●			●	●			●	●	●	●								II-1078
								●	●	●	●								II-1084
				●	●			●	●	●	●								II-1096
				●	●			●	●	●	●								II-1108
									●										II-1118
									●	●									II-1144
									●	●	●		●	●					II-1154
									●	●	●		●	●					II-1198
								●	●	●		●							II-1218
								●	●	●		●							II-1218
								●	●	●		●							II-1226
								●	●	●		●							II-1226
								●	●	●		●							II-1236
								●	●	●		●							II-1236
									●	●		●	●						II-1258
									●	●		●	●						II-1270

4 Search by specifications and variation

Single acting (push/pull)

	Series/model series name	Bore size (ø)	Remarks	Page
CAT	Cartridge cylinder	6 to 15	Push type	I-1340
CMK2-S	Medium bore size cylinder	20 to 40	Push type	I-100
CMK2-SR	Medium bore size cylinder	20 to 40	Pull type	I-106
FCH	Flat compact cylinder	25 to 63	Pull type	I-1480
FCS	Flat compact cylinder	25 to 63	Push type	I-1480
MDC2-X	Small direct mounting cylinder	4 to 10	Push type	I-1354
MDC2-Y	Small direct mounting cylinder	4 to 10	Pull type	I-1354
MSD-X	Small compact cylinder	6/8	Push type	I-1430
MSD-Y	Small compact cylinder	6/8	Pull type	I-1430
SCM-X	Round shaped cylinder	20 to 40	Push type	I-254
SCM-Y	Round shaped cylinder	20 to 40	Pull type	I-260
SCPH3	Pencil shaped cylinder	6 to 16	Pull type	I-16
SCPS	Pencil shaped cylinder	2.5/4	Push type	I-16
SCPS3	Pencil shaped cylinder	6 to 16	Push type	I-16
SMG-X	Compact cylinder	6 to 32	Push type	I-1392
SMG-Y	Compact cylinder	6 to 32	Pull type	I-1392
SSD2-X	Compact cylinder	12 to 50	Push type	I-802
SSD2-Y	Compact cylinder	12 to 50	Pull type	I-802
SSD-X	Compact cylinder	12 to 50	Push type	I-1126
SSD-Y	Compact cylinder	12 to 50	Pull type	I-1126
STK-JY	Stopper cylinder	20 to 50	Pull type	I-1548
STK-MY	Stopper cylinder	20 to 50	Pull type	I-1536
STK-Y	Stopper cylinder	20 to 50	Pull type	I-1518

Single acting (push/pull) Single rod Double rod Rodless Rotation-stop Fine speed Low speed Low friction Heat resistance Integrated speed controller
 High load Back to back Stroke adjustable Side installation Air cushioned/rubber-air cushioned Low hydraulic Position locking Two-stage Scraper Valve
 Tandem Metal bush bearing/ball bearing High precision guide Rechargeable battery Clean-room specifications Copper and PTFE free Coolant proof Anti-spatter adherence

Double acting/single rod

	Series/model series name	Bore size (ø)	Remarks	Page
CAC-N	Lightweight clamp cylinder	32/40		II-1046
CAC4	Clamp cylinder	40 to 80		II-1008
CMA2	Medium bore size cylinder	20 to 40		I-208
CMK2	Medium bore size cylinder	20 to 40		I-86
FCD	Flat compact cylinder	25 to 63		I-1480
GLC	Guideless cylinder	40 to 100		II-1198
HCA	High speed cylinder	20 to 100		II-978
HCM	High energy absorption cylinder	20 to 63		II-960
JSC3(-N)/JSC4-N	Brake cylinder	25 to 63/125 to 180		II-774
JSG	Tie rod cylinder with brake	40 to 100		II-742
JSK2	Brake cylinder (small bore size/caulking)	20 to 40		II-706
JSM2	Brake cylinder (small bore size/disassembling)	20 to 40		II-720
LCR	Linear slide cylinder	8 to 25		II-58
LCG	Linear slide cylinder	6 to 25		II-140
LCM	Linear slide cylinder	4.5 to 8		II-10
LCW	Linear slide cylinder	12 to 20		II-204
LCX	Thin linear slide cylinder	25/32		II-254
MDC2	Small direct mounting cylinder	4 to 10		I-1348
MFC	Robot cylinder	30 to 80		II-1218
MSD	Small compact cylinder	6/10		I-1422
MVC	Small cylinder with suction pad	6/10		I-1374
PCC	Pin clamp cylinder	50		II-1118
RCS2	Rotary clamp cylinder	12 to 63		II-1068
RCC2	Rotary clamp cylinder	16 to 63		II-1096
SCA2	Medium bore size cylinder	40 to 100		I-450
SCG	Tie rod cylinder	32 to 100		I-358
SCM	Round shaped cylinder	20 to 100		I-232
SCPD3	Pencil shaped cylinder	6 to 16		I-8
SCS2	Large bore size cylinder	125 to 250	Lubrication	I-626
SCS2-N	Large bore size cylinder	125 to 250	No-lubrication	I-626
SHC	High power cylinder	40 to 100		II-1144
SMG	Compact cylinder	6 to 32		I-1386
SSD2	Compact cylinder	12 to 200		I-752
SSG	Guided super compact cylinder	12 to 100		I-1068
SSD	Compact cylinder	12 to 160		I-1094
UCAC-N	Position locking and lightweight clamp cylinder	32/40		II-1052
STM	Guided cylinder	6/10		II-314
UCAC2	Position locking clamp cylinder	50/63		II-1030
UFCD	Free position locking flat cylinder	25 to 63		II-888
ULK	Brake cylinder	20 to 40		II-680
ULKP	Brake cylinder	16		II-674
USC	Free position locking medium bore size cylinder	40 to 100		II-904
USSD	Position locking compact cylinder	20 to 100		II-846

4 Search by specifications and variation

Double acting/double rod

Series/model series name		Bore size (ø)	Remarks	Page
CMK2-D	Small bore size cylinder	20 to 40		I-154
FCD-D	Flat compact cylinder	25 to 63		I-1494
SCA2-D	Medium bore size cylinder	40 to 100		I-540
SCG-D	Tie rod cylinder	32 to 100		I-406
SCM-D	Round shaped cylinder	20 to 100		I-308
SCPD3-D	Pencil shaped cylinder	6 to 16		I-44
SCS2-D	Medium bore size cylinder	125 to 250	Lubrication	I-648
SCS2-ND	Medium bore size cylinder	125 to 250	No-lubrication	I-648
SSD2-D	Compact cylinder	12 to 200		I-868
SSD-D	Compact cylinder	12 to 160		I-1188
STR2-MD	Twin rod cylinder	6 to 32		II-612

Rodless

Series/model series name		Bore size (ø)	Remarks	Page
SRL3	Rodless cylinder double acting	12 to 100		I-1574
SRL3-G	Rodless cylinder resin guide	12 to 100		I-1590
SRL3-Q	Rodless cylinder with position locking function	12 to 100		I-1604
SRL3-GQ	Rodless cylinder With resin guide/position locking function	12 to 100		I-1614
SRG3	High precision guided rodless cylinder double acting	12 to 25		I-1650
SRM3	High precision guided rodless cylinder double acting	25 to 63		I-1676
SRM3-Q	High precision guided rodless cylinder position locking	25 to 63		I-1676
SRT3	Rodless cylinder with brake Double acting	12 to 63		I-1706
MRL2	Magnet rodless cylinder basic	6 to 32		I-1740
MRL2-G	Magnet rodless cylinder Simplified guide 1-piston	6 to 32		I-1740
MRL2-W	Magnet rodless cylinder Simplified guide 2-piston	6 to 32		I-1740
MRG2	Magnet rodless cylinder With high precision guide	10 to 25		I-1766
SM-25	Shuttle mover	25		I-1784

Rotation-stop

Rotation-stop of piston rod is possible.

Series/model series name		Bore size (ø)	Remarks	Page
CKV2-M	Compact cylinder with valve	20 to 40	Double acting/with valve	I-692
CMK2-M	Small bore size cylinder	20 to 40		I-166
SCG-M	Tie rod cylinder	32 to 63		I-412
SCM-M	Round shaped cylinder	20 to 40		I-334
SCPD3-M	Pencil shaped cylinder	10/16		I-56
SCPS3-M	Pencil shaped cylinder	10/16	Single acting/push	I-56
SMG-M	Compact cylinder	6 to 32		I-1404
SSD-M	Compact cylinder	12 to 63		I-1220
SSD2-M	Compact cylinder	12 to 63		I-910

Single acting (push/pull) Single rod **Double rod** Rodless Rotation-stop Fine speed Low speed Low friction Heat resistance Integrated speed controller
 High load Back to back Stroke adjustable Side installation Air cushioned/rubber-air cushioned Low hydraulic Position locking Two-stage Scraper Valve
 Tandem Metal bush bearing/ball bearing High precision guide Rechargeable battery Clean-room specifications Copper and PTFE free Coolant proof Anti-spatter adherence

Fine speed

Realizing smooth ultra low speed operation without stick-slip (1 mm/s up).

	Series/model series name	Bore size (ø)	Remarks	Page
CMK2-F	Medium bore size cylinder	20 to 40		I-148
GRC-F	Table rotary actuator	-	Effective torque (N·m) 0.5, 1.0, 2.0, 3.0, 5.0, 8.0	II-1316
LCR-F	Linear slide cylinder	12 to 25		II-112
MDC2-F	Small direct mounting cylinder	6 to 10		I-1364
MRL2-F	Magnet rodless cylinder	6 to 32		I-1740
MSD-F	Small compact cylinder	6/8		I-1450
MSD-KF	Small compact cylinder high load	6 to 16		I-1450
MSDG-LF	Small compact cylinder guided	12/16		I-1462
SCPD3-F	Pencil shaped cylinder	6 to 16		I-34
SCM-F	Round shaped cylinder	20 to 40		I-292
SMG-F	Compact cylinder	6 to 32		I-1400
SSD2-F	Compact cylinder	12 to 100		I-854
SSD2-KF	Compact cylinder high load	12 to 100		I-854
SSD-F	Compact cylinder	12 to 100		I-1172
SSD-KF	Compact cylinder high load	12 to 100		I-1172
ST _L ^S - _B F	Guided cylinder	8 to 80		II-512
STR2- _B F	Twin rod cylinder	10 to 32		II-610

Low speed

Realizing smooth low speed operation without stick-slip (10 mm/s up).

	Series/model series name	Bore size (ø)	Remarks	Page
SCG-O	Tie rod cylinder	32 to 100		I-396
SCM-O	Round shaped cylinder	20 to 100		I-298
SCPD3-O	Pencil shaped cylinder	6 to 16		I-40
SSD2-O	Compact cylinder	12 to 100		I-858
SSD-O	Compact cylinder	12 to 100		I-1178
ST _L ^S - _B O	Guided cylinder	8 to 80		II-514
STR2- _B O	Twin rod cylinder	6 to 32		II-602

Low friction

Low friction cylinder which realizes minimum sliding resistance for use with low pressure through high pressure.

	Series/model series name	Bore size (ø)	Remarks	Page
SCA2-U	Medium bore size cylinder	40 to 100		I-534
SCG-U	Tie rod cylinder	32 to 100		I-402
SCM-U	Round shaped cylinder	20 to 100		I-302
SSD2-KU	Compact cylinder	20 to 100		I-864
SSD-KU	Compact cylinder	20 to 100		I-1184

Heat resistance

	Series/model series name	Bore size (ø)	Remarks	Page
CMK2-T	Medium bore size cylinder	20 to 40		I-124
JSC3-T	Brake cylinder	40 to 100		II-830
SCA2-T	Medium bore size cylinder	40 to 100		I-488
SCM-T	Round shaped cylinder	20 to 100		I-278
SCPD3-DT	Pencil shaped cylinder	6 to 16	Double acting/double rod	I-44
SCPD3-T	Pencil shaped cylinder	6 to 16		I-26
SCS2-T	Large bore size cylinder	125 to 250		I-644
SSD-T	Compact cylinder	12 to 100		I-1138
SSD2-T1	Compact cylinder	12 to 100		I-820
ST _L ^S - _B T	Guided cylinder	12 to 80		II-476

4 Search by specifications and variation

Integrated speed controller

Series/model series name		Bore size (ø)	Remarks	Page
CMK2-Z	Medium bore size cylinder	20 to 40		I-172
SCPD3-Z	Pencil shaped cylinder	10/16		I-50

High load

Series/model series name		Bore size (ø)	Remarks	Page
MFC-BK	Robot cylinder	30 to 80	With brake	II-1226
MFC-BSK	Robot cylinder	30 to 80	With brake sensor	II-1236
MFC-K	Robot cylinder	30 to 80		II-1218
MSD-K	Small compact cylinder	6 to 16		I-1440
SCPD3-K	Pencil shaped cylinder	6 to 16		I-64
SSD2-K	Compact cylinder	12 to 100		I-776
SSD2-K-*C	Compact cylinder	20 to 100		I-832
SSD-K	Compact cylinder	12 to 100		I-1116
SSD-K-*C	Compact cylinder	32 to 100	With rubber-air cushion	I-1150
USSD-K	Position locking compact cylinder	20 to 100		II-846

Back to back

Two air cylinders integrated as back to back can be individually controlled.

Series/model series name		Bore size (ø)	Remarks	Page
CMK2-B	Medium bore size cylinder	20 to 40		I-160
SCA2-B	Medium bore size cylinder	40 to 100		I-548
SCM-B	Round shaped cylinder	20 to 40		I-316
SCS2-B	Large bore size cylinder	125 to 250		I-654
SSD2-B	Compact cylinder	12 to 100		I-890
SSD-B	Compact cylinder	12 to 100		I-1200

Stroke adjustable

Series/model series name		Bore size (ø)	Remarks	Page
CMK2-P	Medium bore size cylinder	20 to 40	Push	I-112
CMK2-R	Medium bore size cylinder	20 to 40	Pull	I-118
LCM-P	Linear slide cylinder	4.5 to 8	Push	II-18
LCM-R	Linear slide cylinder	4.5 to 8	Pull	II-24
SCA2-P	Medium bore size cylinder	40 to 100	Push	I-472
SCA2-R	Medium bore size cylinder	40 to 100	Pull	I-480
SCM-P	Round shaped cylinder	20 to 40	Push	I-266
SCM-R	Round shaped cylinder	20 to 40	Pull	I-272
SCS2-P	Large bore size cylinder	125 to 250	Push	I-640
ST ^S _L -MP	Guided cylinder	8 to 80	Push	II-470

Side installation

Series/model series name		Bore size (ø)	Remarks	Page
LCM-A	Linear slide cylinder	4.5 to 8		II-30

Single acting (push/pull) Single rod Double rod Rodless Rotation-stop Fine speed Low speed Low friction Heat resistance **Integrated speed controller**
 High load Back to back Stroke adjustable Side installation Air cushioned/rubber-air cushioned **Low hydraulic** Position locking Two-stage Scraper Valve
 Tandem Metal bush bearing/ball bearing High precision guide Rechargeable battery Clean-room specifications Copper and PTFE free Coolant proof Anti-spatter adherence

Air cushioned/rubber-air cushioned

	Series/model series name	Bore size (ø)	Remarks	Page
CMK2-C	Medium bore size cylinder	20 to 40	With air cushion	I-136
CMK2-*C	Medium bore size cylinder	20 to 40	With rubber-air cushion	I-128
MRL2-*C	Magnet rodless cylinder	6 to 32	With rubber-air cushion	I-1740
SCPD3-*C	Pencil shaped cylinder	6 to 16	With rubber-air cushion	I-28
SSD2-K-*C	Compact cylinder	20 to 100	With rubber-air cushion	I-832
SSD-K-*C	Compact cylinder	32 to 100	High load/with rubber-air cushion	I-1150
STG _B ^M -*C	Guided cylinder	32 to 63		II-350
STG _B ^M C	Guided cylinder	16 to 63		II-358
ST _L ^S - _B ^M -*C	Guided cylinder	32 to 80	With rubber-air cushion	II-486
ST _L ^S - _B ^M C	Guided cylinder	25 to 80	With air cushion	II-492

Low hydraulic

	Series/model series name	Bore size (ø)	Remarks	Page
CMK2-H	Medium bore size cylinder	20 to 40		I-178
JSC3-H	Brake cylinder	40 to 180		II-818
SCA2-H	Medium bore size cylinder	40 to 100		I-568
SCS2-H	Large bore size cylinder	125 to 250		I-662

Position locking

Piston rod can be mechanically held at the stroke end.

	Series/model series name	Bore size (ø)	Remarks	Page
CMK2-Q	Medium bore size cylinder	20 to 40		I-142
LCR-Q	Linear slide cylinder	8 to 25		II-84
LCG-Q	Linear slide cylinder	8 to 25		II-164
LCX-Q	Thin linear slide cylinder	25/32		II-264
LCW-Q	Linear slide cylinder	12 to 20		II-224
PCC-Q	Pin clamp cylinder	50		II-1118
SCA2-Q2	Medium bore size cylinder	40 to 100		I-494
SCG-Q	Tie rod cylinder	32 to 100		I-374
SCM-Q	Round shaped cylinder	20 to 100		I-282
SRL3-GQ	Rodless cylinder	12 to 100	With resin guide	I-1614
SRL3-Q	Rodless cylinder	12 to 100		I-1604
SRM3-Q	Rodless cylinder	25 to 63		I-1676
SSD2-Q	Compact cylinder	20 to 100		I-840
SSD-Q	Compact cylinder	16 to 100		I-1160
STG _B ^M Q	Guided cylinder	20 to 63		II-368
ST _L ^S - _B ^M Q	Guided cylinder	20 to 80		II-500
STR2- _B ^M Q	Twin rod cylinder	16 to 32		II-592
UCAC-N	Position locking and lightweight clamp cylinder	32/40		II-1052
USSD	Position locking compact cylinder	20 to 100	High load	II-846
USSD-K	Position locking compact cylinder	20 to 100		II-846
UFCD	Free position locking flat cylinder	25 to 63		II-888
USC	Free position locking medium bore size cylinder	40 to 100		II-904

4 Search by specifications and variation

Two-stage

Two cylinders are integrated in serial and individually controlled.

Series/model series name		Bore size (ø)	Remarks	Page
SCA2-W	Medium bore size cylinder	40 to 100		I-556
SCM-W	Round shaped cylinder	20 to 40		I-322
SCS2-W	Large bore size cylinder	125 to 250		I-658
SSD-W	Compact cylinder	12 to 100		I-1210
SSD2-W	Compact cylinder	12 to 100		I-902

Scraper

The heavy duty scrapers on the piston and guide rods prevent entry of contaminants.

Series/model series name		Bore size (ø)	Remarks	Page
SCG-G	Tie rod cylinder	32 to 100		I-418
SCA2-G	Medium bore size cylinder	40 to 100		I-576
SCS2-G	Large bore size cylinder	125 to 250		I-668
SSD2-G	Compact cylinder	20 to 100		I-936
STG- ^{MG} _{L-BG1}	Guided cylinder	20 to 63		II-376
ST ^S _L - ^{MG} _{BG1}	Guided cylinder	20 to 80		II-518
USC-G1	Free position locking medium bore size cylinder	40 to 100		II-904

Valve

Series/model series name		Bore size (ø)	Remarks	Page
CAV2	Cylinder with valve	50 to 100	Double acting/double solenoid/lubrication	I-710
CAV2-N	Cylinder with valve	50 to 100	Double acting/double solenoid/no lubrication	I-710
CAV2-NS	Cylinder with valve/cushioned short overall length	50 to 100	Double acting/double solenoid/no lubrication	I-710
CAV2-S	Cylinder with valve/cushioned short overall length	50 to 100	Double acting/double solenoid/lubrication	I-710
CKV2	Small cylinder with valve	20 to 40	Double acting	I-680
CKV2-M	Small cylinder with valve	20 to 40	Double acting/rotation-stop	I-692
COVN2	Cylinder with valve	50 to 100	Double acting/single solenoid/retracted in when energized/lubrication	I-710
COVN2-N	Cylinder with valve	50 to 100	Double acting/single solenoid/retracted in when energized/no lubrication	I-710
COVN2-NS	Cylinder with valve/cushioned short overall length	50 to 100	Double acting/single solenoid/retracted in when energized/no lubrication	I-710
COVN2-S	Cylinder with valve/cushioned short overall length	50 to 100	Double acting/single solenoid/retracted in when energized/lubrication	I-710
COVP2	Cylinder with valve	50 to 100	Double acting/single solenoid/push out when energized/lubrication	I-710
COVP2-N	Cylinder with valve	50 to 100	Double acting/single solenoid/push out when energized/no lubrication	I-710
COVP2-NS	Cylinder with valve/cushioned short overall length	50 to 100	Double acting/single solenoid/push out when energized/no lubrication	I-710
COVP2-S	Cylinder with valve/cushioned short overall length	50 to 100	Double acting/single solenoid/push out when energized/lubrication	I-710
JSC3-V	Brake cylinder	40 to 100	Double acting/with valve for brake	II-810
JSG-V	Tie rod cylinder with brake	40 to 100	Double acting/with valve for brake release	II-742
JSK2-V	Brake cylinder (small bore size/caulking)	20 to 40	Double acting	II-706
JSM2-V	Brake cylinder (small bore size/disassembling)	20 to 40	Double acting	II-720
SCA2-V	Medium bore size cylinder	40 to 100	Double acting	I-596
SCPD3-V	Pencil shaped cylinder	10/16	Double acting	I-70
SCPS3-V	Pencil shaped cylinder	10/16	Single acting	I-70
ST ^S _L - ^M _B V	Guided cylinder	20 to 80	Double acting	II-544
ULK-V	Brake cylinder	20 to 40	Double acting	II-680

Single acting (push/pull) Single rod Double rod Rodless Rotation-stop Fine speed Low speed Low friction Heat resistance Integrated speed controller
 High load Back to back Stroke adjustable Side installation Air cushioned/rubber-air cushioned Low hydraulic Position locking **Two-stage Scraper Valve**
 Tandem Metal bush bearing/ball bearing High precision guide Rechargeable battery Clean-room specifications Copper and PTFE free Coolant proof Anti-spatter adherence

Tandem

Two air cylinders connected in serial output double force.

Series/model series name	Bore size (ø)	Remarks	Page
SCM-W4	Round shaped cylinder	20 to 40	I-328

Metal bush bearing/ball bearing

Series/model series name	Bore size (ø)	Remarks	Page
STG- ^M _B	Guided cylinder	12 to 80	II-336
STG- ^M _B - *C	Guided cylinder	32 to 63	With rubber-air cushion II-350
STG- ^M _B C	Guided cylinder	16 to 63	With air cushion II-358
STG- ^M _B Q	Guided cylinder	20 to 63	Position locking II-368
STG- ^M _B G	Guided cylinder	20 to 63	Rubber scraper II-376
STG- ^M _B G1	Guided cylinder	20 to 63	Coil scraper II-376
STG- ^{MG2} _{MG3}	Guided cylinder	20 to 63	Coolant proof II-382
STG- ^M _{BG4}	Guided cylinder	40 to 63	Anti-spatter adherence II-388
STG-MG5	Guided cylinder	20 to 100	Metal bush bearing II-394
STM- ^M _B	Guided cylinder	6/10	II-314
ST ^S _L - ^M _B C	Guided cylinder	25 to 80	With air cushion II-492
ST ^S _L - ^M _B - *C	Guided cylinder	32 to 80	With rubber-air cushion II-486
ST ^S _L - ^{MG1} _{BG1}	Guided cylinder	20 to 80	Scraper II-518
ST ^S _L - ^M _B P	Guided cylinder	8 to 80	Adjustable stroke type/push II-470
ST ^S _L - ^M _B T2	Guided cylinder	12 to 80	Packing material fluoro rubber II-480
ST ^S _L - ^M _B T	Guided cylinder	12 to 80	Heat resistance II-476
ST ^S _L - ^M _B O	Guided cylinder	8 to 80	Low speed II-514
ST ^S _L - ^M _B V	Guided cylinder	20 to 80	Valve equipped II-544
ST ^S _L - ^M _B	Guided cylinder	8 to 80	II-448
ST ^S _L - ^M _B Q	Guided cylinder	20 to 80	Position locking II-500
STR2- ^M _B O	Twin rod cylinder	6 to 32	Low speed II-602
STR2- ^M _B	Twin rod cylinder	6 to 32	II-580
STR2- ^M _B Q	Twin rod cylinder	16 to 32	Position locking II-592
STR2- ^M _B D	Twin rod cylinder	6 to 32	Double acting/double rod II-612
UCA2	Unit cylinder	10 to 32	Metal bush bearing II-640
UCA2-B	Unit cylinder	10 to 32	Ball bearing II-650

High precision guide

Series/model series name	Bore size (ø)	Remarks	Page
LCR	Linear slide cylinder	6 to 25	II-58
MSDG-L	Small compact cylinder	6 to 16	I-1452
SRG3	Rodless cylinder	12 to 25	I-1650
SRM3	Rodless cylinder	25 to 63	I-1676

4 Search by specifications and variation

Specifications for rechargeable battery

Pneumatic components exclusively for materials which can be used in the rechargeable battery manufacturing process.

Series/model series name		Bore size (ø)	Remarks	Page
BHA -P4*	Compact cross roller parallel hand	12 to 25		
BHE -P4*	Centering hand	12 to 32		
BHG -P4*	Compact cross roller parallel hand (with rubber cover)	12 to 25		
CKG-G -P4*	3-way jaw bearing chuck (with rubber cover)	16 to 50		
CKL2 -P4*	Powerful chuck	20 to 100		
CKLB2 -P4*	2-way powerful chuck	20 to 100		
CMK2 -P4*	Medium bore size cylinder	20 to 40		
FC* -P4*	Flat cylinder	25 to 63		
FCK -P4	Shock absorber	-		
FJ -P4	Floating fitting	-		
FK -P40	Simplified floating fitting	-		
GRC -P4*	Table rotary actuator	-		
HAP -P4*	Parallel hand	15 to 40		
HCP -P4*	Lateral parallel hand	12 to 20		
HKP-G -P4*	Cross roller parallel hand (with rubber cover)	32 to 63		
HLBG -P4*	Bearing thin parallel hand (with rubber cover)	12 to 20		
HLC -P4*	Thin long stroke parallel hand	8 to 30		
HLD -P4*	Ultra thin parallel hand	12 to 20		
HMD -P4*	Thin wide angle hand	16, 25		
HMF -P4*	Compact wide parallel hand	12 to 40		
HRL-1 -P4	Guided cylinder (single axis unit)	20 to 63		
LCG -P4*	Linear slide cylinder	6 to 25		
LCR -P4*	Linear slide cylinder	6 to 25		
LCX -P4*	Linear slide cylinder	25, 32		
LHAG -P4*	Linear guide hand (with rubber cover)	12 to 32		
MDC2 -P4*	Small direct mounting cylinder	6 to 10		
MRG2 -P4	High precision guided magnet rodless cylinder	10 to 25		
MRL2 -P4*	Magnet rodless cylinder	6 to 32		
MSD -P4*	Small compact cylinder	6 to 16		
MSDG -P4*	Small guided compact cylinder	6 to 16		
MVC -P4*	Small cylinder with suction pad	6, 10		
NCK -P4*	Shock absorber	-		

CC-1226A
Refer to
"Components
for
rechargeable
battery
production
P4* Series"
catalog.

Single acting (push/pull) Single rod Double rod Rodless Rotation-stop Fine speed Low speed Low friction Heat resistance Integrated speed controller
 High load Back to back Stroke adjustable Side installation Air cushioned/rubber-air cushioned Low hydraulic Position locking Two-stage Scraper Valve
 Tandem Metal bush bearing/ball bearing High precision guide **Rechargeable battery** Clean-room specifications Copper and PTFE free Coolant proof Anti-spatter adherence

Specifications for rechargeable battery

Pneumatic components exclusively for materials which can be used in the rechargeable battery manufacturing process.

Series/model series name		Bore size (ø)	Remarks	Page
SCG -P4*	Tie rod cylinder	32 to 100		CC-1226A Refer to "Components for rechargeable battery production P4* Series" catalog.
SCM -P4*	Round shaped cylinder	20 to 100		
SCPD3 -P4*	Pencil shaped cylinder	6 to 16		
SCS2-N -P4	Large bore size cylinder	125 to 250		
SFR/SFRT -P4	Fine speed fan rotary actuator	-		
SMG -P4*	Compact cylinder	6 to 32		
SMD2 -P4*	Compact cylinder	6 to 32		
SRL3 -P4*	Rodless cylinder	12 to 100		
SRM3 -P4*	Rodless cylinder with high precision guide	25 to 63		
SSD -P4*	Compact cylinder	12 to 160		
SSD2 -P4*	Compact cylinder	12 to 200		
SSG -P4*	Guided super compact cylinder	12 to 100		
STG-B/M -P4*	Guided cylinder	12 to 80		
STK -P4*	Stopper cylinder	25 to 50		
STR2 -P4*	Twin rod cylinder	6 to 32		
UCA2 -P4*	Unit cylinder	10 to 32		
USSD -P4*	Position locking compact cylinder	20 to 100		

4 Search by specifications and variation

Clean-room specifications

Anti-dust generation pneumatic components usable in clean rooms.

	Series/model series name	Bore size (ø)	Remarks	Page
GRC -P72/P53	Table rotary actuator	Torque size 5 to 80		Refer to "Components for clean room specifications" in catalog No. CB-033SA.
LCR -P7*/P5*	Linear slide cylinder	6 to 25		
LCG -P7*	Linear slide cylinder	6 to 25		II-172
LCM -P73	Linear slide cylinder	4.5 to 8		II-40
LCX -P7*	Thin linear slide cylinder	25/32		II-270
MRL2 -P7*/P5*	Rodless cylinder (magnet)	6 to 32		Refer to "Components for clean room specifications" in catalog No. CB-033SA.
MDC2 - P7*/P5*	Small direct mounting cylinder	6 to 10		
SCM - P7*/P5*	Round shaped cylinder	20 to 100		
SCPD3 - P7*/P5*	Pencil shaped cylinder	6 to 16		
SMD2 - P7*/P5*	Compact cylinder	6 to 32		
SSD2 - P7*/P5*	Compact cylinder	12 to 160		
SSD - P7*/P5*	Compact cylinder	16 to 160		
STG - B - P72/P73	Guided cylinder	12 to 63		II-404
STM - B - P7*	Guided cylinder	6/10		II-320
ST _L ^S -B-P7*/P5*	Guided cylinder	8 to 80		Refer to "Components for clean room specifications" in catalog No. CB-033SA.
STR2- _B ^M -P7*/P5*	Twin rod cylinder	6 to 32		
SMG-P7*/P5*	Compact cylinder	6 to 25		

Copper and PTFE free

Pneumatic components for cathode ray tube manufacturing lines.

	Series/model series name	Bore size (ø)	Remarks	Page
CKV2 -P6	Small cylinder	20 to 40		I-680
CMK2 -P6	Medium bore size cylinder	20 to 40		I-86
FC* -P6	Flat compact cylinder	25 to 63		I-1480
FJ	Floating joint	-	Copper and PTFE free as standard	II-1948
HRL-1*	Hybrid robot	20 to 63	Copper and PTFE free as standard	II-1452
MRL2	Rodless cylinder (magnet)	6 to 32	Copper and PTFE free as standard	I-1740
RRC -P6	Rotary actuator (rack and pinion mechanism)	-	Effective torque 0.7, 3, 1, 5.6 N•m	II-1286
SCA2 -P6	Medium bore size cylinder	40 to 100		I-450
SCG-P6	Tie rod cylinder	32 to 100		I-358
SCM -P6	Round shaped cylinder	20 to 100		I-232
SCP*3	Pencil shaped cylinder	6 to 16	Copper and PTFE free as standard	I-8
SCS2 -P6	Large bore size cylinder	125 to 250		I-626
SRL3 -P6	Rodless cylinder	12 to 100		I-1574
SSD2-P6	Compact cylinder	12 to 100	ø12 to ø50 Copper and PTFE free as standard	I-752
SSD -P6	Compact cylinder	12 to 100	ø12 to ø50 Copper and PTFE free as standard	I-1094
STG- _B ^M -P6	Guided cylinder	12 to 80		II-336
ST _L ^S - _B ^M -P6	Guided cylinder	8 to 80		II-448
STR2- _B ^M -P6	Twin rod cylinder	6 to 32		II-580

Single acting (push/pull) Single rod Double rod Rodless Rotation-stop Fine speed Low speed Low friction Heat resistance Integrated speed controller
 High load Back to back Stroke adjustable Side installation Air cushioned/rubber-air cushioned Low hydraulic Position locking Two-stage Scraper Valve
 Tandem Metal bush bearing/ball bearing High precision guide Rechargeable battery Clean-room specifications Copper and PTFE free Coolant proof Anti-spatter adherence

Coolant proof product

Pneumatic components with a special structure with outstanding oil and water resistance.

	Series/model series name	Bore size (ø)	Remarks	Page
CMK2-G $\frac{2}{3}$	Medium bore size cylinder	20 to 40		I-182
CMK2-JG $\frac{2}{3}$	Small bore size cylinder/stainless steel	20 to 40		I-188
SCA2-G $\frac{2}{3}$	Medium bore size cylinder	40 to 100		I-584
SCG-G $\frac{2}{3}$	Tie rod cylinder	40 to 100		I-424
SSD2-G $\frac{2}{3}$	Compact cylinder	16 to 100		I-946
SSD2-KG $\frac{2}{3}$	Compact cylinder high load	16 to 100		I-956
SSD-G $\frac{2}{3}$	Compact cylinder	16 to 100		I-1230
SSD-KG $\frac{2}{3}$	Compact cylinder high load	16 to 100		I-1238
STG-MG $\frac{2}{3}$	Guided cylinder	20 to 63		II-382
ST $\frac{S}{L}$ -BG $\frac{2}{3}$	Guided cylinder	20 to 80		II-526

Anti-spatter adherence

Pneumatic cylinder with a structure preventing spatter adherence from welding.

	Series/model series name	Bore size (ø)	Remarks	Page
CAC4-G4	Clamp cylinder	40 to 80		II-1020
RCS2-G4	Rotary clamp cylinder	32 to 63		II-1084
RCC2-G4	Rotary clamp cylinder	20 to 63		II-1108
SCA2-G $\frac{G1}{G4}$	Medium bore size cylinder	40 to 100		I-590
SCG-G4	Tie rod cylinder	32 to 100		I-430
SSD2-G $\frac{G1}{G4}$	Compact cylinder	25 to 100		I-966
SSD2-K $\frac{G1}{G4}$	Compact cylinder high load	25 to 100		I-974
SSD2-D $\frac{G1}{G4}$	Compact cylinder double rod	25 to 100		I-984
SSD-G $\frac{G1}{G4}$	Compact cylinder	32 to 100		I-1246
SSD-K $\frac{G1}{G4}$	Compact cylinder high load	32 to 100		I-1254
SSD-D $\frac{G1}{G4}$	Compact cylinder double rod	32 to 80		I-1264
STG-MG4	Guided cylinder	40 to 63		II-388
ST $\frac{S}{L}$ -BG $\frac{G1}{G4}$	Guided cylinder	40 to 80		II-536

Environment-resistant scraper

NEW

Pneumatic cylinder suitable for use in an environment containing ceramic fine powder and metal fine powder.

	Series/model series name	Bore size (ø)	Remarks	Page
SSD2-G5	Compact cylinder	20 to 100		I-992
SSD2-KG5	Compact cylinder high load	20 to 100		I-1002
STG-MG5	Guided cylinder	20 to 100		II-394

System selection

Even beginners can easily make a model selection.

How to make a system selection

An overview of the selection is available with the following two conditions.

1

When selecting peripheral pneumatic components, having determined cylinder bore size and operation speed

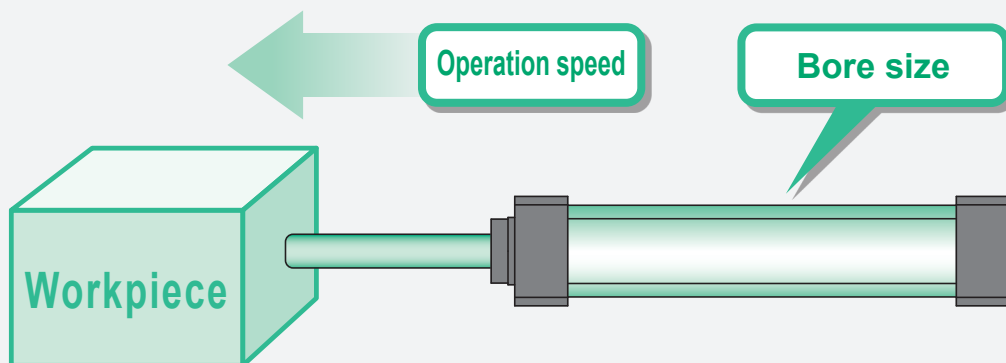

»» To Intro Page **50**

2

When selecting peripheral pneumatic components, having determined bore size from cylinder load and operating time

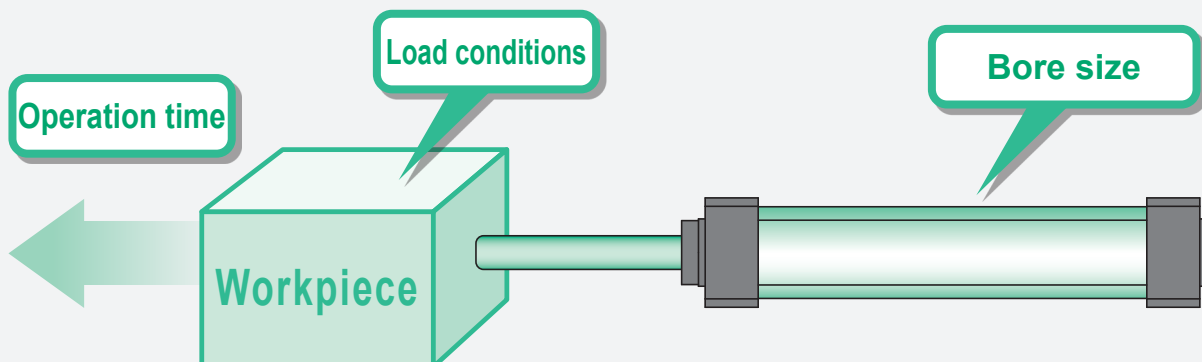

»» To Intro Page **61**

System selection

STEP1 Conditions confirmation/theoretical reference speed selection

As a condition, it is predetermined whether bore size and cylinder are to be operated at a relatively high speed or at a relatively low speed.

Table 1

Degree of cylinder speed	Low speed	Medium speed	High speed	Ultra high speed
Theoretical reference speed (mm/s)	250	500	750	1,000

STEP2 Fluid control components selection

Select appropriate fluid control components (valve, speed controller, silencer, piping) and [required flow rate] for bore size and theoretical reference speed selected from Table 1.

Table 2

Bore size (mm)	Theoretical reference speed (mm/s) Note)	Required flow rate (L/min) (ANR)	Required composite effective cross-sectional area (mm ²)	Valve
				Single solenoid
ø6	500	5	0.1	MN4E010 4SA010/4SB010
ø10	500	14	0.2	MN4E010 4SA010/4SB010
ø16	500	36	0.5	MN4E010 4SA010/4SB010
ø20	250	29	0.5	4KA110/4KB110 4GA110R/4GB110R
	500	56	0.9	4KA110/4KB110
	750	84	1.4	4GA110R/4GB110R
	1,000	112	1.8	
ø25	250	44	0.8	4KA110/4KB110
	500	88	1.4	4GA110R/4GB110R
	750	132	2.1	4KB110/4GB110R
	1,000	175	2.8	4KB210/4GB210R
ø32	250	73	1.3	4KA110/4KB110 4GA110R/4GB110R
	500	143	2.9	4KA210/4KB210
	750	215	3.5	4GA210R/4GB210R
	1,000	286	4.6	

Note) The above table indicates theoretical reference speed at cylinder bore size.

Refer to the individual specifications of each model for the working piston speed range.

① Selecting from cylinder bore size and operation speed

② Selecting from the load value and operation time

*1: Refer to Intro Page 67 for piping specifications.

Suitable control components				
	Double solenoid	Pneumatic auxiliary components		Piping ^{*1}
		Speed controller	Silencer	Piping (between valve and cylinder)
	MN4E020 4SA020/4SB020	SC3W-M5-4 DSC-C-M5-4	SLM-M5,SLM-M3	ø4 x ø2.5 nylon tube
	MN4E020 4SA020/4SB020	SC3W-M5-4 DSC-C-M5-4	SLM-M5,SLM-M3	ø4 x ø2.5 nylon tube
	MN4E020 4SA020/4SB020	SC3W-M5-4 DSC-C-M5-4	SLM-M5,SLM-M3	ø4 x ø2.5 nylon tube
	4KA120/4KB120 4GA120R/4GB120R	SC3W-6-6/SCL2-06-H66 DSC-(C)-6-6/DSC-S1-06-H66	SLM-M5,SLW-6A	ø6 x ø4 nylon tube
	4KA120/4KB120 4GA120R/4GB120R	SC3W-6-6 DSC-(C)-6-6 SCL2-06-H66 DSC-S1-06-H66	SLM-M5,SLW-6A	ø6 x ø4 nylon tube
	4KA120/4KB120 4GA120R/4GB120R	SC3W-6-6 DSC-(C)-6-6 SCL2-06-H66 DSC-S1-06-H66	SLM-M5,SLW-6A	ø6 x ø4 nylon tube
	4KB120/4GB120R	SC1-6 SCL2-08-H88	SLW-6A,SL-M5	ø8 x ø5.7 nylon tube
	4KB220/4GB220R	DSC-S1-08-H88	SLW-6S,SLW-6A	ø8 x ø5.7 nylon tube
	4KA120/4KB120 4GA120R/4GB120R	SC3W-6-6/SCL2-06-H66 DSC-(C)-6-6/DSC-S1-06-H66	SLM-M5,SLW-6A	ø6 x ø4 nylon tube
	4KA220/4KB220 4GA220R/4GB220R	SC1-6 SCL2-08-H88 DSC-S1-08-H88	SLW-6S,SLW-6A	ø8 x ø5.7 nylon tube

System selection

Bore size (mm)	Theoretical reference speed (mm/s) Note)	Required flow rate (L/min) (ANR)	Required composite effective cross-sectional area (mm ²)	Valve
				Single solenoid
ø40	250	110	1.7	
	500	230	3.3	4KA210/4KB210 4GA210R/4GB210R
	750	340	5.0	
	1,000	450	6.6	
ø50	250	180	2.6	4KA210/4KB210 4GA210R/4GB210R
	500	350	5.2	
	750	530	7.7	4GA310R/4GB310R
	1,000	710	10.4	4GA310R/4GB310R 4F310/4F410
ø63	250	280	4.1	4KA210/4KB210 4GA310R/4GB310R
	500	560	8.2	4GA310R/4GB310R
	750	840	12.3	4KA310/4KB310 4F310/4F410
	1,000	1,100	16.4	4F510
ø80	250	450	6.6	4KB210/4F210-08
	500	910	13.2	4F410-10/4F310-10 4KB310-10
	750	1,400	19.8	4KB410-15
	1,000	1,800	26.4	4F510-15
ø100	250	710	10.3	4GA410-10/4GB410-10 4F410-10/4F310-10 4KB310-10
	500	1,400	20.6	4GB410-15
	750	2,100	30.9	4KB410-15/4F510-15
	1,000	2,800	41.2	4F610-20

Note) The above table indicates theoretical reference speed at cylinder bore size.

Refer to the individual specifications of each model for the working piston speed range.

① Selecting from cylinder bore size and operation speed

② Selecting from the load value and operation time

*1: Refer to Intro Page 67 for piping specifications.

Suitable control components			
	Pneumatic auxiliary components		Piping *1
Double solenoid	Speed controller	Silencer	Piping (between valve and cylinder)
	SC3W-6-6 SCL2-06-H66 DSC-(C)-6-6 DSC-S1-06-H66	SLM-M5,SLW-6A	ø6 x ø4 nylon tube
4KA220/4KB220 4GA220R/4GB220R	SC1-6 SCL2-08-H88 DSC-8-8 DSC-S1-08-H88	SLW-6S,SLW-6A	ø8 x ø5.7 nylon tube
	SC1-8	SLW-8A,SLW-6A	ø10 x ø7.2 nylon tube
	SC1-8	SLW-8A,SLW-8S	ø10 x ø7.2 nylon tube
4KA220/4KB220 4GA220R/4GB220R	SC1-6 SCL2-08-H88 DSC-S1-08-H88	SLW-6A,SLW-6S	ø8 x ø5.7 nylon tube
	SC1-8	SLW-8A,SLW-6A	ø10 x ø7.2 nylon tube
4GA320R/4GB320R	SCL2-10-H1010 DSC-S1-10-H1010	SLW-8A,SLW-8S	ø10 x ø7.2 nylon tube
4GA320R/4GB320R 4F320/4F420	SC1-10	SLW-10A	ø15 x ø11.5 nylon tube or Rc3/8 steel pipe
4KA220/4KB220 4GA320R/4GB320R	SC1-6 SCL2-08-H88 DSC-S1-08-H88	SLW-6S,SLW-6A	ø8 x ø5.7 nylon tube
4GA320R/4GB320R	SC1-8 SCL2-10-H1010 DSC-S1-10-H1010	SLW-8A,SLW-8S	ø10 x ø7.2 nylon tube
4KA320/4KB320 4F320/4F420	SC1-10	SLW-10A	ø15 x ø11.5 nylon tube or Rc3/8 steel pipe
4F520	SC1-15	SLW-15A	Rc1/2 steel pipe
4KB220/4F220-08	SC1-8 SCL2-10-H1010 DSC-S1-10-H1010	SLW-8A,SLW-8S	ø10 x ø7.2 nylon tube
4F420-10/4F320-10 4KB320-10	SC1-10	SLW-10A	ø15 x ø11.5 nylon tube or Rc3/8 steel pipe
4KB420-15 4F520-15	SC1-15	SLW-15A	Rc1/2 steel pipe
	SC-20A	SLW-15A	Rc1/2 steel pipe
4GA420-10/4GB420-10 4F420-10/4F320-10 4KB320-10	SC1-10	SLW-10A	ø15 x ø11.5 nylon tube or Rc3/8 steel pipe
4GB420-15 4KB420-15/4F520-15	SC1-15	SLW-15A	Rc1/2 steel pipe
	SC-20A	SLW-15A	Rc1/2 steel pipe
4F620-20	SC-20A	SL-20A,SLW-20S	Rc3/4 steel pipe

System selection

Bore size (mm)	Theoretical reference speed (mm/s) Note)	Required flow rate (L/min) (ANR)	Required composite effective cross-sectional area (mm ²)	Valve	
				Single solenoid	
ø125	250	1,100	16.1	4GB410-15 4KB410-15/4F510-15	
	500	2,200	32.2		
	750	3,300	48.2		
	1,000	4,400	64.4	4F610-20	
ø140	250	1,400	20.2	4GB410-15 4KB410-15/4F510-15	
	500	2,800	40.4		
	750	4,200	60.5	4F610-20	
	1,000	5,500	80.8	4F710-25	
ø160	250	1,800	26.3	4GB410-15 4KB410-15/4F510-15	
	500	3,600	52.6	4F610-20	
	750	5,400	79.0	4F710-20	
	1,000	7,200	104.7	-	
ø180	250	2,300	33.3	4KB410-15 4F510-15	
	500	4,600	66.6	4F710-20	
	750	6,900	100.0	4F710-25	
	1,000	9,200	132.5	-	
ø200	250	2,800	41.2	4F610-20	
	500	5,600	82.4	4F710-25	
	750	8,400	122.7	-	
	1,000	11,200	163.6	-	
ø250	250	4,400	64.3	4F710-20	
	400	7,000	103.0	4F710-25	
	750	13,200	191.7	-	
	1,000	17,600	255.6	-	

① Selecting from cylinder bore size and operation speed

② Selecting from the load value and operation time

*1: Refer to Intro Page 67 for piping specifications.

Suitable control components				
Double solenoid		Pneumatic auxiliary components		Piping *1
		Speed controller	Silencer	Piping (between valve and cylinder)
4GB420-15 4KB420-15/4F520-15		SC1-15	SLW-15A	Rc1/2 steel pipe
		SC-20A	SLW-15A	Rc1/2 steel pipe
4F620-20		SC-20A	SL-20A,SLW-20S	Rc3/4 steel pipe
		SC-20A	SL-20A	Rc3/4 steel pipe
4GB420-15 4KB420-15/4F520-15		SC1-15	SLW-15A	Rc1/2 steel pipe
			SL-20A,SLW-20S	Rc3/4 steel pipe
4F620-20		SC-20A	SL-20A	Rc3/4 steel pipe
4F720-25		SC-20A	SL-25A	Rc1 steel pipe
4GB420-15 4KB420-15/4F520-15		SC-20A	SLW-15A	Rc1/2 steel pipe
	4F620-20	SC-20A	SL-20A	Rc3/4 steel pipe
4F720-20		SC-20A	SL-20A	Rc3/4 steel pipe
-		-	-	-
4KB420-15 4F520-15		SC-20A	SLW-15A	Rc1/2 steel pipe
	4F720-20	SC-20A	SL-20A	Rc3/4 steel pipe
4F720-25		SC-25A	SL-25A	Rc1 steel pipe
-		-	-	-
4F620-20		SC-20A	SL-20A,SLW-20S	Rc3/4 steel pipe
4F720-25		SC-25A	SL-25A	Rc1 steel pipe
-		-	-	-
-		-	-	-
4F720-20		SC-20A	SL-20A	Rc3/4 steel pipe
4F720-25		SC-25A	SL-25A	Rc1 steel pipe
-		-	-	-
-		-	-	-

System selection

STEP 3 Clean air system components selection

Select a component with a max. flow rate equal to or higher than the [required flow rate] value in Table 2.

When controlling multiple cylinders with a single set of clean air system components, select the clean air system component with [max. flow rate] higher than [total required flow rates].

Table 3

F.R.L kit			F.R. unit		
Model No.	Port size	Max flow L/min (Atm press conv value)	Model No.	Port size	Max flow L/min (Atm press conv value)
C1000-6-W	Rc1/8	450	W1000-6-W	Rc1/8	800
C1000-8-W	Rc1/4	630	W1000-8-W	Rc1/4	1,150
C2000-8-W	Rc1/4	1,200	W2000-8-W	Rc1/4	1,500
C2000-10-W	Rc3/8	1,700	W2000-10-W	Rc3/8	2,000
C2500-8-W	Rc1/4	1,200	W3000-8-W	Rc1/4	2,150
C2500-10-W	Rc3/8	1,700	W3000-10-W	Rc3/8	2,430
C3000-8-W	Rc1/4	1,280	W4000-8-W	Rc1/4	2,500
C3000-10-W	Rc3/8	1,750	W4000-10-W	Rc3/8	4,350
C4000-8-W	Rc1/4	1,430	W4000-15-W	Rc1/2	4,750
C4000-10-W	Rc3/8	2,400	W8000-20-W	Rc3/4	10,000
C4000-15-W	Rc1/2	3,000	W8000-25-W	Rc1	10,000
C6500-20-W	Rc3/4	4,500	B7019-1C	Rc1/8	500
C6500-25-W	Rc1	5,000	B7019-2C	Rc1/4	900
C8000-20-W	Rc3/4	7,000			
C8000-25-W	Rc1	7,500			
K60570-1C-GB	Rc1/8	200			
K60570-2C-GB	Rc1/4	300			

Explanation of technical terms

[Theoretical reference speed]: indicates degree of cylinder speed, expressed as the following formula.

(This value coincides with speed at no load. When load is applied, speed drops considerably.)

$$VO = 1920 \times \frac{S}{A} = 2445 \times \frac{S}{D^2} \quad (1)$$

VO: Theoretical reference speed (mm/s)

A: Cylinder sectional area (cm²)

S: Composite effective cross-sectional area of circuit (exhaust air side) (mm²)

D: Cylinder bore size (cm)

When expressed as a graph, the theoretical reference speed is the speed within the range where the cylinder moves at a uniform speed

$$VO = \frac{Q}{t_3} \quad (\text{mm/s})$$

t1: Time until movement starts

t2: Time of primary delay

t3: Operating time with constant velocity

Q: Stroke

* Note/t1 and t2 differ depending on load. At no load, this can be ignored to no ill effect.

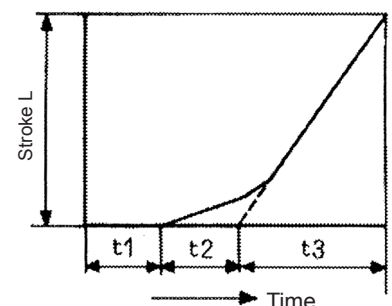

① Selecting from cylinder bore size and operation speed

② Selecting from the load value and operation time

■ F.R.L. kit, unit, regulator
Primary pressure 0.7 MPa, set pressure 0.5 MPa, pressure drop 0.1 MPa

■ Air filter
Primary pressure 0.7 MPa, pressure drop 0.02 MPa

■ Lubricator
Primary pressure 0.5 MPa, pressure drop 0.03 MPa

Air filter (F)			Regulator (R)			Lubricator (L)		
Model No.	Port size	Max flow ℓ/min (Atm press conv)	Model No.	Port size	Max flow ℓ/min (Atm press conv)	Model No.	Port size	Max flow ℓ/min (Atm press conv)
F1000-6-W	Rc1/8	460	R1000-6-W	Rc1/8	770	L1000-6-W	Rc1/8	550
F1000-8-W	Rc1/4	610	R1000-8-W	Rc1/4	1,350	L1000-8-W	Rc1/4	700
F2000-8-W	Rc1/4	1,300	R2000-8-W	Rc1/4	1,750	L3000-8-W	Rc1/4	1,100
F2000-10-W	Rc3/8	1,700	R2000-10-W	Rc3/8	2,500	L3000-10-W	Rc3/8	2,250
F3000-8-W	Rc1/4	1,230	R3000-8-W	Rc1/4	2,000	L4000-8-W	Rc1/4	1,000
F3000-10-W	Rc3/8	1,500	R3000-10-W	Rc3/8	2,600	L4000-10-W	Rc3/8	1,700
F4000-8-W	Rc1/4	1,320	R4000-8-W	Rc1/4	2,500	L4000-15-W	Rc1/2	2,700
F4000-10-W	Rc3/8	2,140	R4000-10-W	Rc3/8	4,400	L8000-20-W	Rc3/4	6,300
F4000-15-W	Rc1/2	3,000	R4000-15-W	Rc1/2	5,000	L8000-25-W	Rc1	10,000
F6000-20-W	Rc3/4	5,600	R6000-20-W	Rc3/4	7,000	A3019-1C	Rc1/8	100
F6000-25-W	Rc1	6,200	R6000-25-W	Rc1	7,700	A3019-2C	Rc1/4	400
F8000-20-W	Rc3/4	6,400	R8000-20-W	Rc3/4	14,000	3003E-6C	Rc3/4	3,500
F8000-25-W	Rc1	6,800	R8000-25-W	Rc1	11,000	3003E-8C	Rc1	4,000
A1019-1C	Rc1/8	550	B2019-1C	Rc1/8	500			
A1019-2C	Rc1/4	700	B2019-2C	Rc1/4	500			
1138-6C-E	Rc3/8	5,500	2215-6C	Rc3/4	14,000			
1138-8C-E	Rc1	7,000	2215-8C	Rc1	14,000			
			2215-10C	Rc1 1/4	14,000			

[Required flow rate]: indicates instantaneous flow rate for operating a cylinder with velocity v_0 , expressed with the following formula. Values in the table are when $P = 0.5$ MPa. The required flow rate is a value necessary to select clean air system components.

$$Q \approx \frac{A v_0 (P + 0.101) \times 60}{0.101 \times 10^4} \quad \text{---(2)}$$

Q: Required flow rate (ℓ/min) (ANR)

P: Supply pressure (MPa)

[Required effective sectional area]: indicates composite effective cross-sectional area for the exhaust circuit required for moving the cylinder at speed v_0 .

(Composite effective cross-sectional area of valve, speed controller, silencer or piping)

[Proper standard system]: indicates the most appropriate combination of valve, speed controller, silencer and bore size for operating a cylinder with velocity v_0 . The combination in the table is for a pipe length of 1 m.

System selection

A combination of the valve and the cylinder's standard system (example)

- (1) The cylinder average speed is obtained from the combination of the valve and piping system. It is expressed as the cylinder's piston speed calculated by dividing the stroke by the time that the piston rod takes from start to end of movement with the cylinder rod installed facing upward. When the load factor is 50%, the average speed should be approximately the cylinder's piston speed multiplied by 0.5. (Refer to Intro Page 61 for the relation of load factor and theoretical reference speed.)
- (2) The cylinder's average speed is that when one cylinder is operated independently.
- (3) The effective cross-sectional area of the solenoid valve used for the calculation below is the 2-position value.
- (4) This selection guide is for reference. Check the selection with actual conditions using a sizing program.
- (5) Graph for the 4G and 4K Series valve (2-position single, base piping) is shown as an example.

4G Series

(With internal exhaust check valve)

(Example) The connection component system No. is ② for the 4G1 with a C6 port size.

Series	Base piping						System No.
	Model No.	Solenoid valve Port size	Speed Controller	Silencer	Piping(1m)	Composite effective cross-sectional area (mm ²) Pipe length (1 m)	
4G1	M4GB110R	C4	SC3W-6-4	SLW-6S	ø4 x ø2.5	1.4	①
	M4GB110R	C6	SC1-6	SLW-6S	ø6 x ø4	2.8	②
4G2	M4GB210R	C6	SC1-8	SLW-8S	ø6 x ø4	4.5	③
	M4GB210R	C8	SC1-10	SLW-8S	ø8 x ø5.7	6.7	④
4G3	M4GB310R	C10	SC1-10	SLW-10L	ø10 x ø7.2	10.1	⑤
	M4GB310R	C10	SC1-15	SLW-10L	ø12 x ø8.9	11.5	⑥

* The system No. is indicated in the following graph.

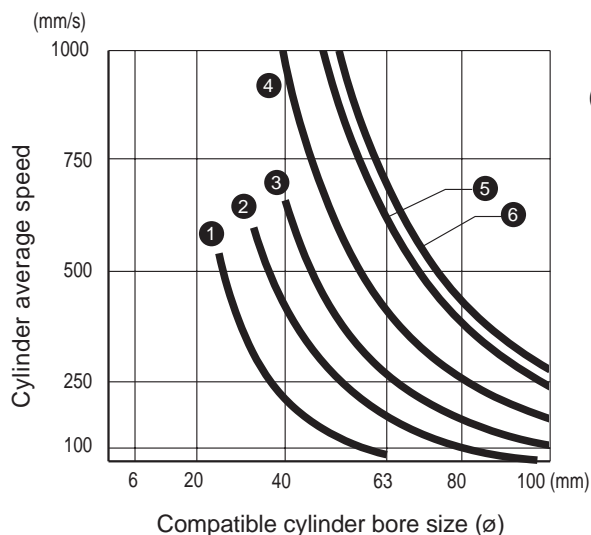

(Example) When using system ② with ø40 cylinder diameter, the cylinder's average speed is about 450 mm/s. (Note that this differs with working conditions.)

- ① Selecting from cylinder bore size and operation speed
- ② Selecting from the load value and operation time

MN4G Series (With internal exhaust check valve)

Series	Solenoid valve port size	Speed controller	Piping (1 m)	Common exhaust piping	Composite effective X-sectional area (mm ²)	System No.
MN4G1	C4	SC3W-M5-4	ø4xø2.5	ø6xø4x3 m	0.9	①
	C4	SC3W-6-4	ø4xø2.5	ø6xø4x3 m	1.4	②
	C6	SC1-6	ø6xø4	ø8xø5.7x3 m	2.8	③
MN4G2	C6	SC1-6	ø6xø4	ø8xø5.7x3 m	3.8	④
	C8	SC1-8	ø8xø5.7	ø10xø7.2x3 m	6.0	⑤

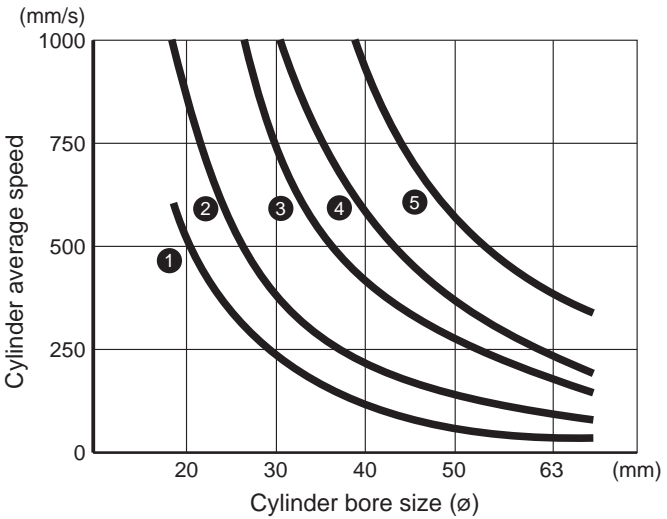

* The system No. is indicated in the following graph.
 * This graph applies to common exhaust.

4K Series

Series	Solenoid valve port size	Speed controller	Silencer	Piping (1 m)	Composite effective X-sectional area (mm ²)	System No.
4KB110	C6	SC1-6	SLW-6S	ø6xø4	3.2	①
4KB210	C8	SC1-8	SLW-8S	ø8xø5.7	7.7	②
4KB310	C10	SC1-10	SLW-10L	ø10xø7.2	14.1	③
4KB410	C15	SC1-15	SLW-15A	ø12xø8.9	23.6	④

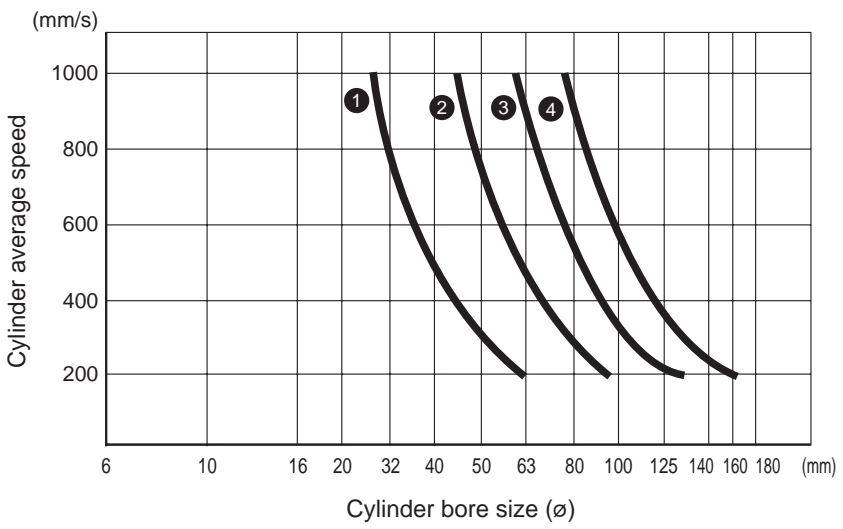

* The system No. is indicated in the following graph.

System selection

2

Selecting from the load value and operation time

How to select

When load (N) and cylinder required operation time (S) are already decided, use [System selection 2] to select an appropriate model. Follow the following procedures.

STEP 1

[Confirming conditions]

Load value (N),
Required operation time (S)



STEP 2

Selecting cylinder bore size

From Graph 1



STEP 3

Selecting theoretical reference speed

From Graph 2



STEP 4

Selecting a suitable system

From Graph 3



STEP 5

Selecting suitable components

From Table 1

STEP 1 Confirming conditions

- (1) Load $F = \square$ (N)
- (2) Required operation time $t = \square$ (s)
- (3) Stroke $L = \square$ (mm)
- (4) Pressure $P = \square$ (MPa)

M: Weight of body (kg)

μ : Friction coefficient (normally $\mu \approx 0.3$)

F: Load (N)

g: 9.8 m/s²

● Vertical

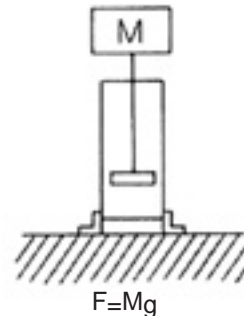

● Horizontal

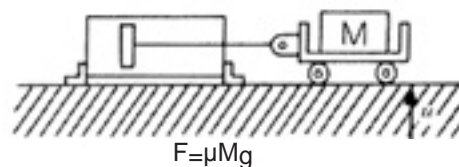

- ❶ Selecting from cylinder bore size and operation speed
- ❷ Selecting from the load value and operation time

STEP 2 Selecting cylinder bore size

According to the nomogram for cylinder bore size, select the cylinder bore size and read the load factor at the same time. (Normally, for value F of “Step 1 Confirming conditions”, read the cylinder bore size whose load factor is close to 50%)

Cylinder bore size $D = \varnothing$

(Example) When $F = 800\text{N}$, $P = 0.5\text{MPa}$, cylinder bore size is $\varnothing 63$ at Load factor 50% .

Graph 1 Nomogram to find cylinder bore size

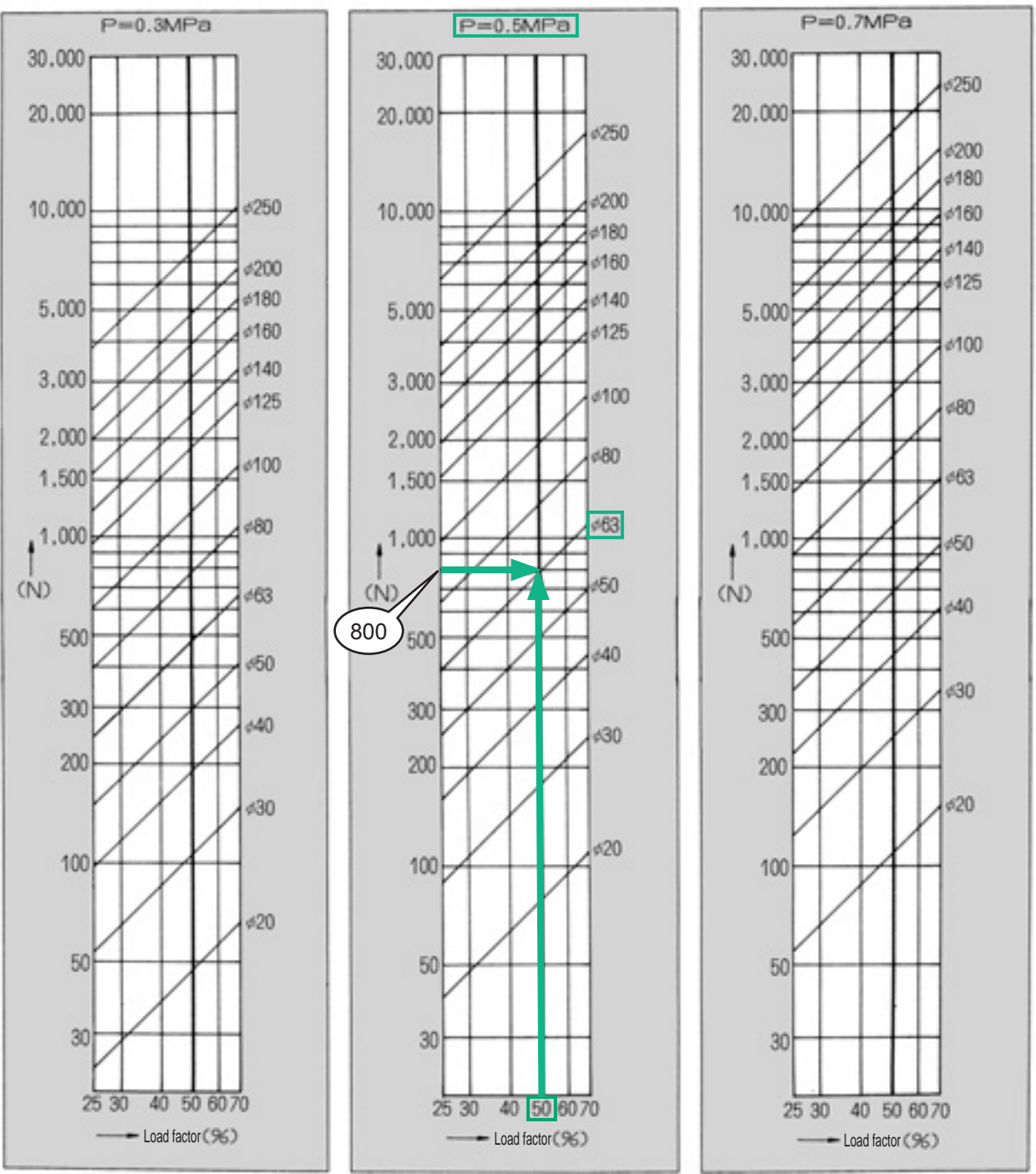

System selection

STEP 3 Selecting theoretical reference speed

According to $t-v_0$ graph, read v_0 value to obtain the required operation time t (sec).

$v_0 = \square$

(Example) When **Load factor 50%** and **Stroke of 200mm** cylinder operate with **1.0sec**,
theoretical reference speed is **450 mm/s**.

Graph 2 $t-v_0$ graph

Load factor 0%

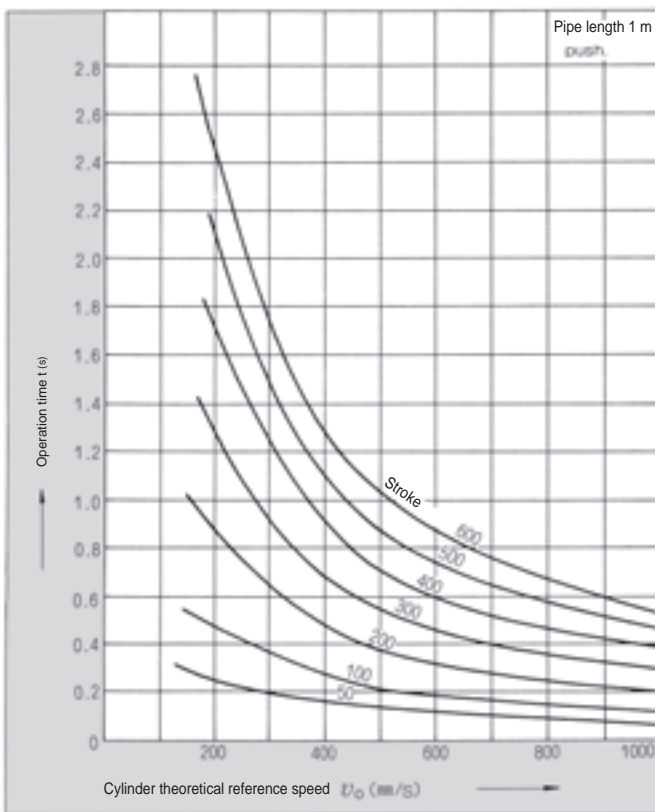

Load factor 25%

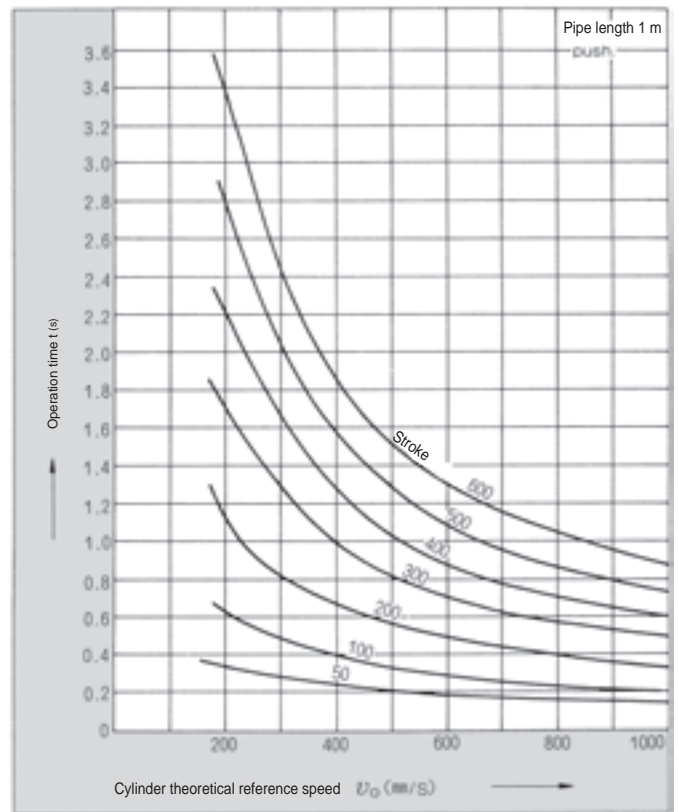

1 Selecting from cylinder bore size and operation speed

2 Selecting from the load value and operation time

Load factor 50%

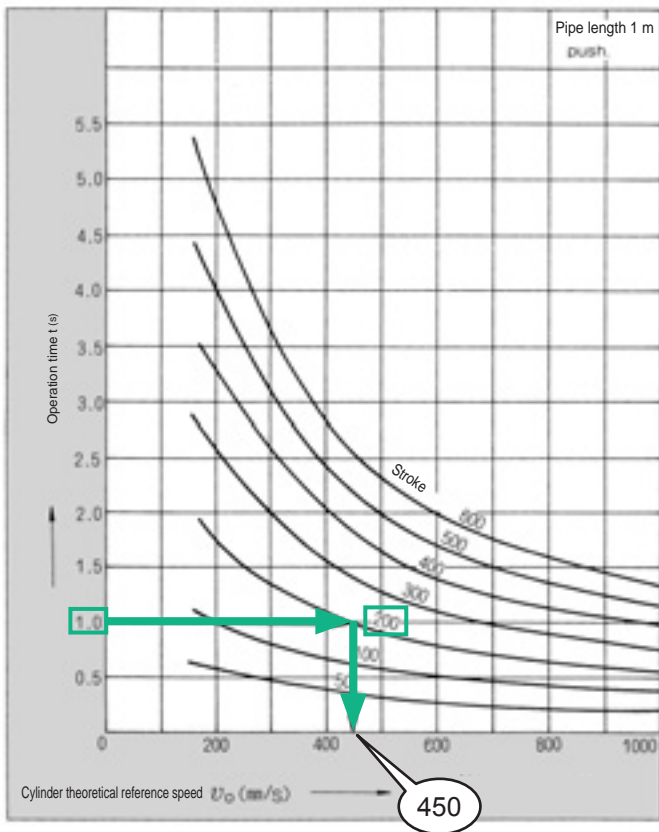

Load factor 70%

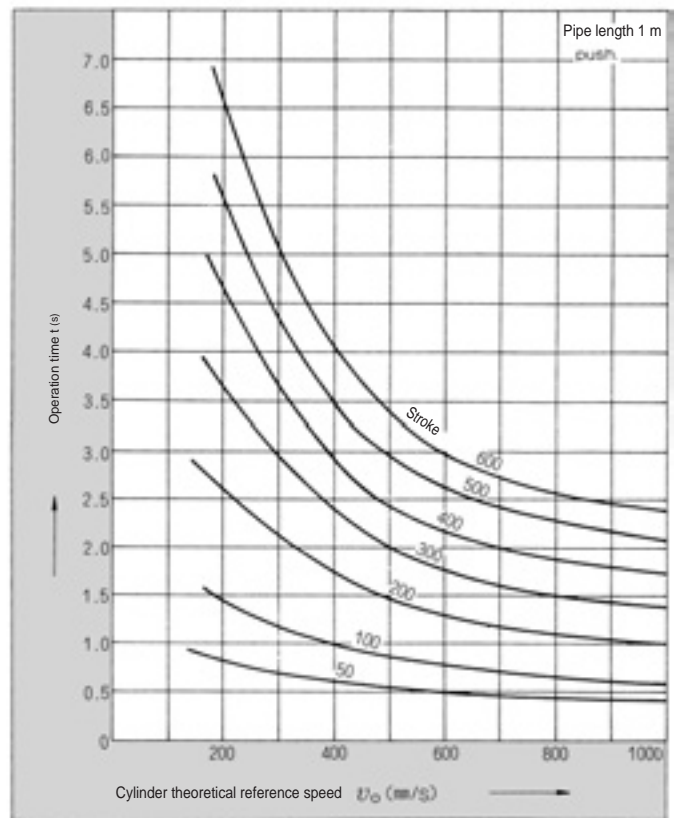

System selection

STEP 4 Selecting a suitable system

In the system selection table, find the cross point of V_0 obtained in [STEP 3 Selecting theoretical reference speed] and ϕD obtained in [STEP 2 Selecting cylinder bore size], and from the cross point, trace a line extended straight up to read the system code.

System code

(Example) In order to operate at theoretical reference speed , is ideal.

Graph 3 System selection table

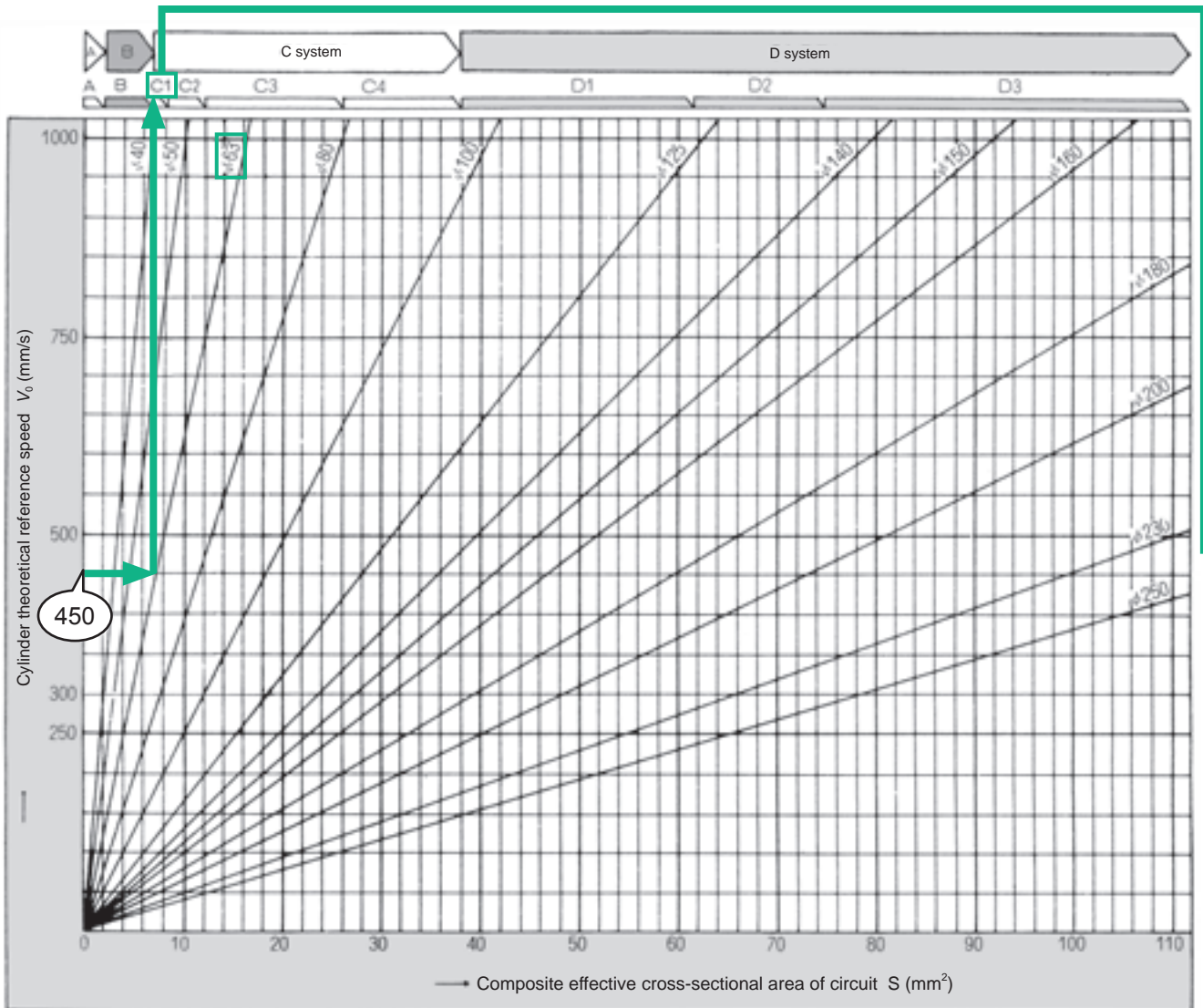

- ① Selecting from cylinder bore size and operation speed
- ② Selecting from the load value and operation time

STEP 5 Selecting suitable components

According to the standard system table, confirm the model No. of proper system components with the code found in [STEP 4 Selecting a suitable system].

(Example) CI system	
Valve <input type="checkbox"/>	Valve: Single 4KB210-08 or 4GB310R-08 Double 4KB220-08 or 4GB320R-08
Speed controller <input type="checkbox"/>	Speed controller: SCI-8
Silencer <input type="checkbox"/>	Silencer: SLW-8A
Piping <input type="checkbox"/>	Piping: $\phi 10 \times \phi 7.2$ nylon tube 1 m

Table 1 Standard system table

Standard system No.	Valve		Speed controller	Silencer	Piping	Composite eff X-sect area (mm ²) pipe 1 m
	Single solenoid	Double solenoid				
A	4SB010-M5 4KA110-GS4	4SB020-M5 4KA120-GS4	SC3W-M5-4 (SC-M5)	SLM-M5	$\phi 4 \times \phi 2.5$ Nylon tube	0.9
B1	4KA110-GS6 4KB110-06	4KA120-GS6 4KB120-06	SC3W-6-6 SCL2-06-H66	SLM-M5 SLW-6A	$\phi 6 \times \phi 4$ Nylon tube	2.0
B2	4KB110-06 4GB110R-06	4KB120-06	SC1-6 SCL2-08-H88	SL-M5 SLW-6A	$\phi 8 \times \phi 5.7$ Nylon tube	3.0
B3	4GB210R-06 4KB210-06	4KB220-06	SC1-6 SCL2-08-H88	SLW-6A SLW-6S	$\phi 8 \times \phi 5.7$ Nylon tube	5.2
B4	4GB210R-08 4KB210-08	4GB220R-08 4KB220-08	SC1-8 SCL2-10-H1010	SLW-6A SLW-8A	$\phi 10 \times \phi 7.2$ Nylon tube	6.4
C1	4GB210R-08 4KB210-08 4F210-08	4GB220R-08 4KB220-08 4F220-08	SC1-8 SCL2-10-H1010	SLW-8A SLW-8S	$\phi 10 \times \phi 7.2$ Nylon tube	7.8
C2	4GB310R-10 4F310-10 4KB310-10	4GB320R-10 4F320-10 4KB320-10	SC1-10	SLW-10A	$\phi 10 \times \phi 7.2$ Nylon tube or Rc3/8 steel pipe	12
C3	4GB410-15 4F510-15 4KB410-15	4GB420-15 4F520-15 4KB420-15	SC1-15	SLW-15A	Rc1/2 steel pipe	27
C4	4GB410-15 4F510-15 4KB410-15	4GB420-15 4F520-15 4KB420-15	SC-20A	SLW-15A	Rc1/2 steel pipe	38
D1	4F610-20	4F620-20	SC-20A	SL-20A	Rc3/4 steel pipe	64
D2	4F710-20	4F720-20	SC-20A	SL-20A	Rc3/4 steel pipe	80
D3	4F710-25	4F720-25	SC-25A	SL-25A	Rc1 steel pipe	112

Effective cross-sectional area for steel pipes and nylon tubes, and recommended max. flow rate for gas pipes

Effective cross-sectional area of steel pipe

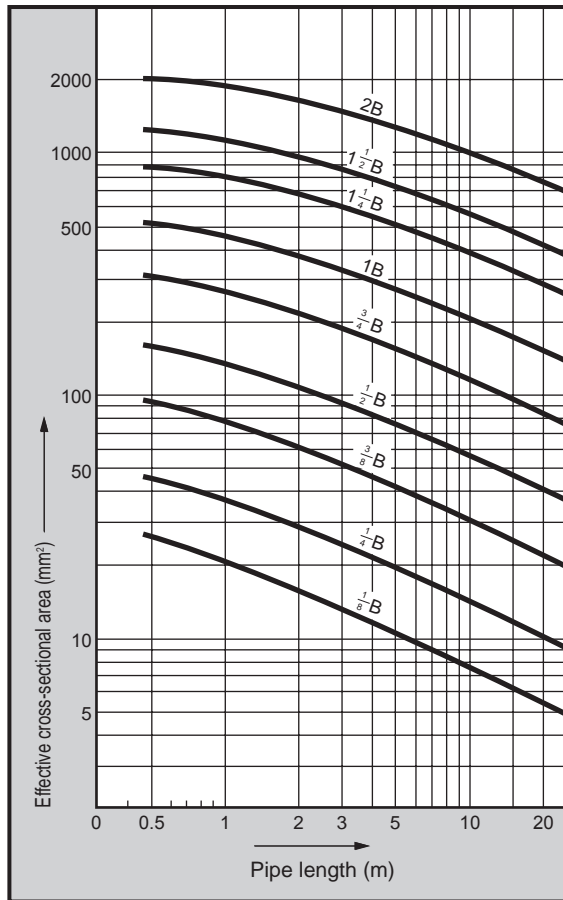

Effective cross-sectional area of nylon tube

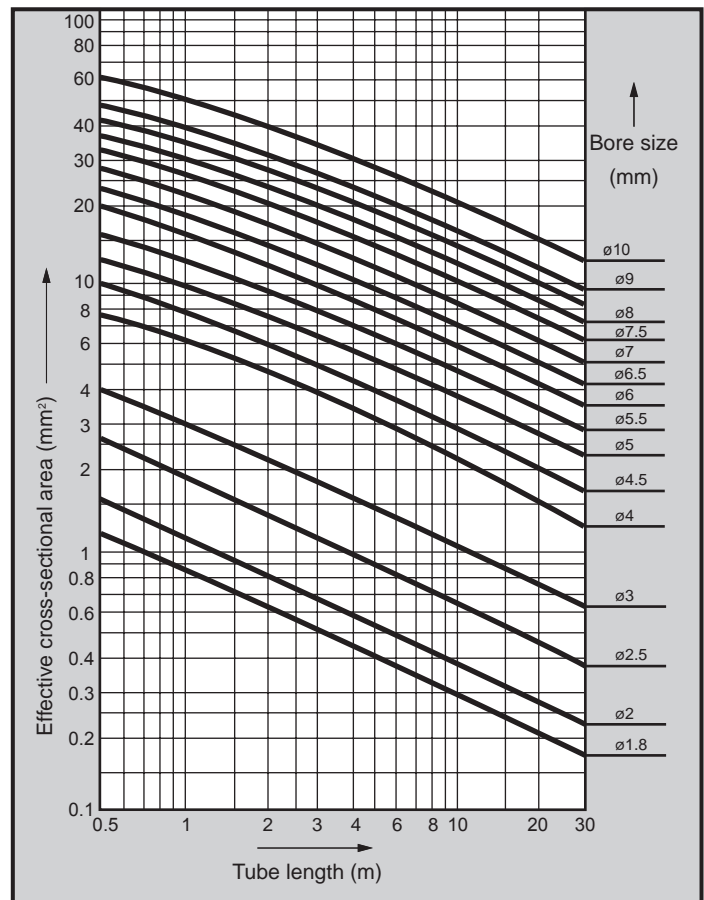

Recommended max. flow rate table of gas tube

Nominal size	1/8B	1/4B	3/8B	1/2B	3/4B	1B	1 1/4B	1 1/2B
Pressure drop MPa (*1)	0.124	0.0707	0.0576	0.0425	0.0276	0.0209	0.0133	0.0105
Inlet pressure MPa	Recommended max. flow rate (L/min)							
0.05	127	244	518	838	1,465	2,460	3,870	5,150
0.1	146	282	598	965	1,690	2,828	4,460	5,950
0.15	163	314	668	1,076	1,885	3,150	4,960	6,630
0.2	179	344	730	1,180	2,060	3,450	5,430	7,280
0.3	206	395	840	1,360	2,375	3,900	6,300	8,400
0.4	230	442	940	1,520	2,660	4,450	7,000	9,360
0.5	252	485	1,030	1,660	2,920	4,875	7,700	10,250
0.6	272	523	1,110	1,800	3,140	5,250	8,300	11,050
0.7	292	558	1,185	1,920	3,350	5,620	8,870	11,800
0.8	308	592	1,260	2,035	3,560	5,970	9,430	12,570
0.9	324	623	1,325	2,140	3,745	6,290	9,900	13,220
1.0	340	654	1,395	2,250	3,930	6,600	10,400	13,880
1.2	370	717	1,510	2,450	4,280	7,150	11,250	15,040
1.4	398	763	1,625	2,624	4,590	7,700	12,100	16,200
1.5	410	790	1,680	2,710	4,740	7,930	12,550	16,780

(*1: Inlet pressure = 0.5 MPa)
Gas pipe length: 10 m

(Remarks)

In the main line where the piping distance tends to increase, it is necessary to consider a pressure drop occurring at the end of the main line when air passes.

The recommended max. flow rate refers to the max. flow rate that can be recommended in the range of allowable pressure drop with respect to piping length, determined from actual use.

This does not mean that a higher flow is not possible, but rather that the pressure will further decrease if the flow exceeds this value.

Flow characteristics display method

1. Flow characteristics display

The catalog specifications indicate the flow rate as follows.

Applicable components	Indicator	Unit	Standards
Pneumatic components	New JIS compliant indication	C, b	ISO 6358:1989 "Pneumatic fluid Components -Flow characteristics test method" JIS B 8390:2000 (ISO 6358 translation)
	Conventional indication	S	JIS B 8373:1993 "Pneumatic 2-port solenoid valves" JIS B 8374:1993 "Pneumatic 3-port solenoid valves" JIS B 8375:1993 "Pneumatic 4, 5-port solenoid valve" JIS B 8379:1995 "Pneumatic noise reduction device"
		Cv	ANSI(NFPA)T3. 21. 3:1990

2. Explanation

The flow characteristics of the solenoid valves were conventionally indicated with the effective cross-sectional area S. However, JIS was revised (JIS B 8390:2000), and these are now indicated with the sonic conductance C and critical pressure ratio b.

- **Sonic conductance C:** Value obtained by dividing the passage weight flow of the component in the choke flow by the sum of the upstream absolute pressure and standard state density. (sonic conductance) $S \approx 5.0 C$ (Conventional sizing is possible with C.)
- **Critical pressure ratio b:** Pressure ratio at which choked flow results if smaller than this value (downstream pressure/upstream pressure) (critical pressure ratio)
- **Effective cross-sectional area S (mm²):** The value of the ideal restricted cross-sectional area without friction or compressed flow, calculated from the pressure changes inside the air tank when the choke flow is released from the components mounted on the air tank.

* Choke flow: Flow at which upstream pressure is higher than downstream pressure, and speeds at certain sections of components reach acoustic velocity. The fluid's mass flow rate is proportional to the upstream pressure, and is not dependent on downstream pressure. (Choked flow)

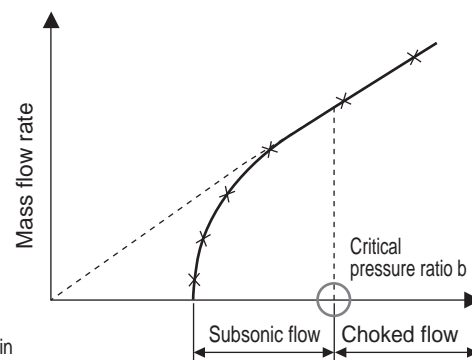

Fig. 1 Mass flow characteristics for upstream pressure

Flow rate formula

Depending on the actual unit, they are shown as follows.

$$\frac{P_2+0.1}{P_1+0.1} \text{ Choked flow when } \leq b$$

$$Q=600 \times C(P_1+0.1) \sqrt{\frac{293}{273+t}} \dots\dots(1)$$

$$\frac{P_2+0.1}{P_1+0.1} \text{ Subsonic flow when } > b$$

$$Q=600 \times C(P_1+0.1) \sqrt{1 - \left[\frac{\frac{P_2+0.1}{P_1+0.1} - b}{1-b} \right]^2} \sqrt{\frac{293}{273+t}} \dots\dots(2)$$

- Q : Air flow rate [dm³/min(ANR)], SI unit dm³ (cubic decimeter) can also be expressed with L (liter). 1dm³ = 1L
- C : Sonic conductance [dm³/(s·bar)]
- b : Critical pressure ratio [-]
- P₁ : Upstream pressure [MPa]
- P₂ : Downstream pressure [MPa]
- t : Temperature (°C)

To calculate effective cross-sectional area S, substitute the value C obtained with $C = S/5$ above in the above formula. For subsonic flow, substitute $b = 0.5$ in formula (2).



Degree of protection



- Degree of protection
- IEC (International Electrotechnical Commission) standards (IEC60529)
- JIS C 0920 : 2003



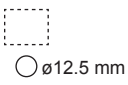
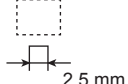
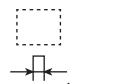

IP-

Degree of protection (International Protection)

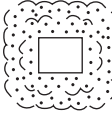
1st characteristic No. (degree of protection for foreign solid matter)

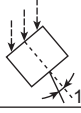
2nd characteristic No. (degree of protection for water entry)

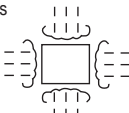
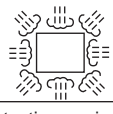
1st character No.	Degree of protection	
0	No protection	Without protection
1		Protection against inflow of solids 50 mm and over in diameter
2		Protection against inflow of solids 12.5 mm and over in diameter
3		Protection against inflow of solids 2.5 mm and over in diameter
4		Protection against inflow of solids 1.0 mm and over in diameter
5	Dust-proof 	No inflow of dust at levels adversely affecting normal device operation or safety
6	Dust proof 	No inflow of dust

2nd character No.	Degree of protection	
0	No protection	
1	Protection against water dripping 	No harmful effects from water dripping vertically.
2	Protection against dripping water tilted at an angle of up to 15° 	Water dripping vertically has no adverse effect when the product is tilted at an angle of up to 15° from its normal position.
3	Protection for watering 	Water falling as a spray at any angle up to 60° from the vertical has no adverse effect.
4	Protection against splashing water 	Water splashing against the product from any direction has no adverse effect.
5	Protection against water jets 	No harmful effects occur even when water is sprayed with nozzles from all directions.
6	Protection against powerful jets 	Water projected in powerful jets against the product from any direction has no adverse effect.
7	Protection against immersion 	Water will not enter the product even when it is immersed in water under defined conditions.
8	Protection against immersion 	The product can be used for continuous immersion in water.