

Assembly and Maintenance Manual

Type AA

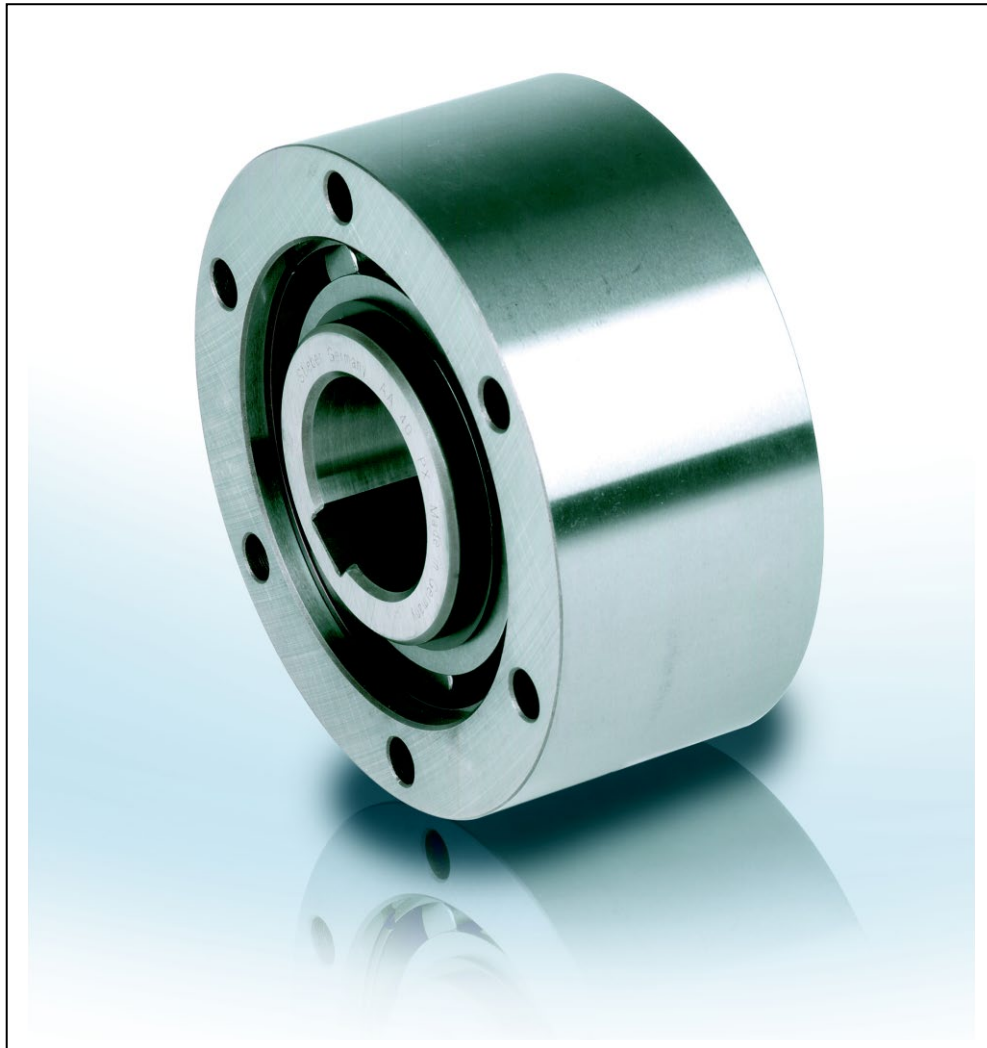

 **STIEBER**[™]
A REGAL REXNORD BRAND

Hatschekstr.36
69126 Heidelberg
Germany
Tel +49(0)6221 30470
Fax +49(0)6221 304731
info@stieber.de
www.stieber.de

Date of issue: 26.03.2024 GB

Revision: 0

U:\EngUsers\ProduktDoku\1AAA_Einbauerklaerung_Wartungsanleitung_Konformitaetsserklaerung\1AAA_Wartungsanleitungen\Original_Worddatei\M1005E_0_AA.docx

General safety instructions





	WARNING	<p>Risk of injury due to moving components! Rotating, driven components can cause severe injuries. Therefore, during operation:</p> <ul style="list-style-type: none"> ➤ It is strictly forbidden for persons to loiter in the hazard area or in its immediate vicinity. ➤ Do not disable, render unusable, or circumvent safety equipment and/or safety functions. <p>Prior to entering the hazard area:</p> <ul style="list-style-type: none"> ➤ Switch off the power supply and secure it against being switched on again. ➤ Wait for still moving components to come to a standstill.
	DANGER!	<p>Danger due to improper operation!</p> <ul style="list-style-type: none"> ➤ Modifications to the one-way clutch are not permitted and may impair safety. ➤ All tasks may only be performed by personnel with the requisite training and expertise. ➤ Repairs and maintenance tasks may only be performed when the machine is at a standstill. The machine is therefore to be secured against a restart.
	WARNING	<p>Risk of injury due to the one-way clutch falling down or tipping over! The weight of the one-way clutch can injure people and cause severe crushing. Therefore:</p> <ul style="list-style-type: none"> ➤ When lifting, use suitable lifting gear (slings, etc.) able to support the weight of the one-way clutch.
	WARNING	<p>Risk of injury due to incorrect assembly! Incorrect assembly and maintenance can cause severe property damage and personal injury. Assembly, maintenance, and repair work may only be performed by personnel with the requisite training and expertise.</p>
	WARNING	<p>Risk of injury for insufficiently qualified personnel! Improper handling can cause significant personal injury and property damage. Therefore:</p> <ul style="list-style-type: none"> ➤ Only ever have tasks performed by those persons to whom the tasks have been assigned.

Table of contents	Page
General safety instructions	2
1 General.....	4
1.1 Information relating to the assembly and maintenance manual	4
1.2 Explanation of symbols	4
1.3 Manufacturer.....	5
1.4 Labeling	5
1.5 Environmental protection	5
2 Safety	5
2.1 Intended use	5
2.2 Responsibility of the operator.....	6
2.3 Assembly and maintenance personnel.....	7
2.4 Personal protective equipment.....	7
2.5 Limitations of use	8
3 Structure and function	9
3.1 Structure	9
3.2 Functional principle	10
4 Transport and packaging.....	10
5 Storage.....	11
5.1 Short-term storage	11
5.2 Long-term storage.....	11
6 Installation	12
6.1 Checking the direction of rotation.....	12
6.2 Changing the direction of rotation.....	12
6.3 Lubrication	14
6.3.1 Operation with oil lubrication	14
6.3.2 Operation with grease lubrication	14
6.4 Assembly	15
6.5 Mounting example.....	16
7 Maintenance	17
7.1 Oil change.....	18
7.2 Maintenance when using grease lubrication.....	18
8 Disassembly	19
9 Disposal	19
10 Faults	20
11 Spare parts	20

1 General

1.1 Information relating to the assembly and maintenance manual

This assembly and maintenance manual provides important information regarding the installation and commissioning of the one-way clutches of types AA.





The prerequisite for safe operation is compliance with all of the stated safety and handling instructions.

Moreover, the relevant local accident protection guidelines and general safety provisions for the field of application of the one-way clutch are to be complied with.

Read the assembly and maintenance manual carefully prior to installation and commissioning. The manual is a product component and must be kept in the immediate vicinity of the installation site and be accessible to personnel at all times. Furthermore, all safety instructions stated in the assembly and maintenance manual are to be observed.

1.2 Explanation of symbols

Warnings are marked throughout this assembly and maintenance manual by symbols. These warnings are introduced by signal words that indicate the extent of the danger. Comply with the warnings under all circumstances and act with due care and attention to avoid accidents, personal injury, and property damage.

	DANGER!	...indicates an imminently dangerous situation that can be fatal or cause severe injuries if it is not averted.
	WARNING	...indicates a potentially dangerous situation that can be fatal or cause severe injuries if it is not averted.
	ATTENTION	...indicates a potentially dangerous situation that can cause minor or light injuries if it is not averted.
	CAUTION	...indicates a potentially dangerous situation that can cause property damage if it is not averted.
	NOTICE	... highlights helpful tips and recommendations as well as information for efficient and trouble-free operation.

1.3 Manufacturer

STIEBER GMBH, D-69126 Heidelberg, Hatschekstr. 36, Germany
Phone +49 (0) 6221 3047-0, Fax -31

1.4 Labeling

External surface of the outer ring

- Manufacturer
- Type designation
- Date of manufacture (coded)

1.5 Environmental protection

Energy: The one-way clutch does not use any electrical energy.

Materials: Steel

Recycling: Steel parts are up to 100% recyclable.

2 Safety

2.1 Intended use

One-way clutches of types AA are automatically switching clutches dependent on the direction of rotation. They are used as overrunning clutches, backstops, or switching clutches in machines and systems.

One-way clutches may only be operated within the limitations of use outlined in Section 2.5.

All of the specifications stated in the assembly and maintenance manual must be strictly adhered to.

Any claims due to damage arising from improper use are excluded. The operator bears sole liability for all damage arising from improper use.

Driving operation of an overrunning clutch:

When the driving machine elements are operated in the pulling direction, the driving machine element and the torque-supporting machine element are connected to each other in a force-locked manner by the overrunning clutch. In this operating state, output can be transmitted.

Overrun operation of an overrunning clutch:

The overrunning clutch automatically releases the force-locked connection of the driving machine element and the driven machine element if the torque of the driven machine element is higher than that of the driving machine element.

Lockout operation of a backstop:

When the machine shaft is operated in the reverse direction, the machine shaft and the torque-supporting machine element are connected to each other in a force-locked manner by the one-way clutch. In this operating state, a torque is transmitted.

Overrun operation of a backstop:

The one-way clutch automatically releases the force-locked connection between the machine shaft and the torque-supporting machine element, providing the machine shaft is operated in the overrun direction.

Driving operation of an indexing clutch:

When the machine shaft is operated in the pulling direction, the machine shaft and the torque-supporting machine element are connected to each other in a force-locked manner by the one-way clutch. In this operating state, an output is transmitted.

Idling operation of an indexing clutch:

The one-way clutch automatically releases the force-locked connection between the machine shaft and the torque-supporting machine element, providing the machine shaft is operated in the idling direction.

2.2 Responsibility of the operator

The operator of the system in which the one-way clutch is installed is subject to the legal obligations concerning occupational safety.

The valid provisions for the site of operation as well as the safety and accident prevention regulations of the trade association are to be observed. In particular, this means that the operator:

- is aware of the valid occupational safety provisions
- implements at the site of operation the necessary behavioral requirements for operation of the system in which the one-way clutch is installed
- clearly defines responsibilities for installation, operation, maintenance, and cleaning of the system in which the one-way clutch is installed
- ensures that all staff members who work at or with the system in which the one-way clutch is installed have read and understood the operation manual. Moreover, the operator must, at regular intervals, provide training for personnel on how to handle the system in which the one-way clutch is installed, and inform them of the potential dangers. In addition, the operator is responsible for ensuring that the system in which the one-way clutch is installed:
 - is always in perfect technical condition

- is maintained in accordance with the specified maintenance intervals
- has all its safety equipment checked regularly for completeness and functionality

2.3 Assembly and maintenance personnel

	WARNING	Risk of injury for insufficiently qualified personnel! Improper handling can cause significant personal injury and property damage. Therefore: <ul style="list-style-type: none">➤ Only ever have tasks performed by those persons to whom the tasks have been assigned.
---	----------------	--

Qualified personnel are those persons who, owing to their training, experience, and instruction as well as their knowledge of relevant standards, provisions, accident prevention regulations and operating conditions, have been authorized by the person responsible for the safety of the system to perform the requisite tasks and are able to recognize and avoid potential dangers in doing so. Knowledge of first-aid measures and on-site emergency equipment is also required.

2.4 Personal protective equipment

In order to minimize health risks, it is necessary to wear personal protective equipment when handling the system in which the one-way clutch is installed.

Above all, the necessary protective equipment such as work shoes, gloves, safety goggles, etc. is to be put on prior to all tasks and kept on during the task.

2.5 Limitations of use

- Maximum permissible overrun rotation speeds and maximum permissible torques (grease quantities):

Type AA	max. Bohrung [mm]	Max. torque [Nm]	Max. overrun rotation speed [rpm]		Axial play S [mm]	admissible runout (T.I.R.) outer race to shaft [mm]	admissible axial run-out outer race to shaft [mm]	Quantity/ Size fastening screws	Grease quantity [cm ³]
			n _{max} innen	n _{max} außen					
12	12	34	3100	6200	4,50	0,02	0,03	3x M5	1,7
15	15	110	2300	5600	4,50	0,02	0,03	3 x M5	4,2
20	20	292	2000	4800	5,50	0,035	0,03	4 x M5	8,4
25	25	570	1700	4000	6,50	0,06	0,03	6 x M5	10,5
30	30	1000	1500	3400	6,50	0,06	0,03	6 x M6	12,5
35	35	1440	1300	2800	6,50	0,06	0,03	6 x M6	17
40	40	2060	1200	2500	7,60	0,06	0,03	6 x M8	22
45	45	2250	1050	2200	7,60	0,06	0,03	8 x M8	27
50	50	4300	950	2050	7,60	0,06	0,03	8 x M8	36
55	55	5350	850	1950	7,60	0,1	0,045	8 x M10	46
60	60	7000	800	1800	7,60	0,1	0,045	10 x M10	63
70	70	11626	650	1700	7,60	0,1	0,045	10 x M10	90
80	80	12500	500	1500	7,60	0,2	0,05	10 x M10	120
90	90	21500	400	1300	7,60	0,2	0,05	10 x M12	156
100	100	30000	350	1150	7,60	0,4	0,05	10 x M16	220
120	120	50000	230	900	9,60	0,4	0,05	12 x M16	350
150	150	115000	160	600	9,60	0,4	0,05	12 x M20	700
200	200	270000	125	460	10,60	0,4	0,05	18 x M24	1600
250	250	450000	100	380	10,60	0,4	0,05	20 x M30	2500

AA..V: Cage design with reinforced springs

AA..VV: Cage design with double reinforced springs

AA..S: modified one- way clutch with axial play "S" which is reduced to a minimum

Tab. 1 Specification

	NOTICE	If the hole diameter is smaller than the maximum, the maximum torque to be transmitted depends on the fitting key connection.
---	---------------	---

- Limits for ambient temperature: -40°C bis +50°C
- Max. operating temperature: 90°C
- Machine shaft tolerance: d = h6 or j6
- Permissible axial misalignment of inner and outer max. $\pm \frac{s}{2}$
- Oil lubrication: approved oils as per Stieber product catalog / WN900
- Grease lubrication: approved greases as per Stieber product catalog / WN900

**NOTICE**

With grease lubrication, the maximum overrun rotation speeds of the outer and inner race decrease by 50%.

**NOTICE**

With grease lubrication, the reinforced spring design V or VV must be used (see table 1 Specification).

3 Structure and function

3.1 Structure

Item 1	Outer race
Item 2	Inner race
Item 3	Cylindrical roller
Item 6	Spring-loading
Item 7	Washer
Item 8	Retaining ring I
Item 9	Retaining ring I

Tab. 2 Parts list

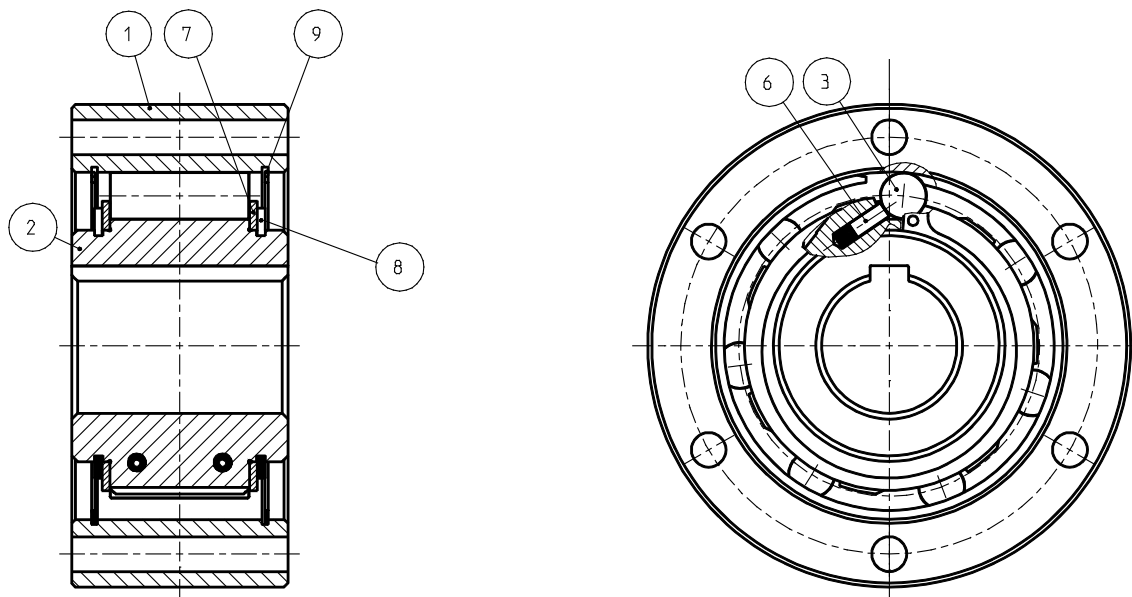

Figure 1 Structure of AA

3.2 Functional principle

AA one-way clutches are fitted with individually spring-loaded clamp rollers. Spring-loading ensures that all clamp rollers are continuously in contact with the one-way clutch's inner and outer race and are thus ready for operation. When turning the inner or outer clutch race (see Fig. 2) in the pulling direction, the rollers create a frictional connection between the inner and outer race so that a torque or output can be transmitted. The torque is always transmitted here from the actuation shaft to the output shaft. In driving operation, the speeds of the inner ring and outer race are identical.

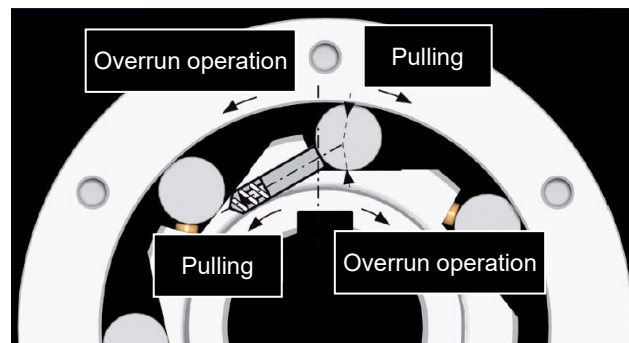

Fig. 2 Pulling/overrun operation

Overrun operation is carried out if the inner race or outer race is turned in the overrun direction. This interrupts the frictional connection (see Fig. 2) between the inner and outer race. In overrun operation the speeds of the inner race and outer race are different.

4 Transport and packaging



NOTICE

The local provisions regarding the disposal of transport and packaging materials are to be observed.

The one-way clutch is shipped in a box or on a pallet.

Transport damage to the packaging and/or the one-way clutch is to be reported to the respective transit company without delay.

The one-way clutch must be unpacked in a clean and dry environment.

5 Storage

5.1 Short-term storage

The type AA is packed in VCI bubble wrap. The VCI bubble wrap is to be checked at regular intervals. The frequency of these intervals is dependent on the environmental conditions (temperature, moisture, salt content of the air, etc.) at the storage site.

The maximum storage period (short-term storage) is 6 months. Moreover, the one-way clutch must have long-term storage corrosion protection applied to it.

Store packages under the following conditions:

- Do not keep outdoors
- Keep dry and free from dust
- Do not expose to aggressive media
- Keep away from direct sunlight
- Avoid mechanical shocks and vibrations
- Storage temperature: -10 to +60°C
- Relative humidity: max. 95%, non-condensing
-

5.2 Long-term storage

For long-term storage, the one-way clutch must be shrink-wrapped with a desiccant and provided with a hygroscope. The corrosion protection must be checked after a period not exceeding one year or else depending on the environmental conditions (temperature, moisture, salt content of the air, etc.) at the storage site.

Store packages under the following conditions:

- Do not keep outdoors
- Keep dry and free from dust
- Do not expose to aggressive media
- Keep away from direct sunlight
- Avoid mechanical shocks and vibrations
- Storage temperature: -10 to +60°C
- Relative humidity: max. 95%, non-condensing

6 Installation

6.1 Checking the direction of rotation

	WARNING	<p>Risk of injury due to incorrect assembly! Incorrect assembly and maintenance can cause severe property damage and personal injury. Assembly, maintenance, and repair work may only be performed by personnel with the requisite training and expertise.</p>
---	----------------	---

	WARNING	<p>Risk of injury due to moving components! Rotating, driven components can cause severe injuries. Therefore, during operation:</p> <ul style="list-style-type: none"> ➤ It is strictly forbidden for persons to loiter in the hazard area or in its immediate vicinity. ➤ Do not disable, render unusable, or circumvent safety equipment and/or safety functions. <p>Prior to entering the hazard area:</p> <ul style="list-style-type: none"> ➤ Switch off the power supply and secure it against being switched on again. ➤ Wait for still moving components to come to a standstill.
---	----------------	---

	WARNING	<p>Risk of injury due to the one-way clutch falling down or tipping over! The weight of the one-way clutch can injure people and cause severe crushing. Therefore:</p> <ul style="list-style-type: none"> ➤ When lifting, use suitable lifting gear (slings, etc.) able to support the weight of the one-way clutch.
---	----------------	--

	WARNING	<p>Risk of injury for insufficiently qualified personnel! Improper handling can cause significant personal injury and property damage. Therefore:</p> <ul style="list-style-type: none"> ➤ Only ever have tasks performed by those persons to whom the tasks have been assigned.
---	----------------	---

Before installation, the direction of rotation of the one-way clutch must be checked.

6.2 Changing the direction of rotation

For AA models, the direction can be reversed by turning round 180 degrees.

Procedural steps:

- Loosen the fastening screws of the outer ring (1) and the driven or torque-supporting machine element.
- Remove the axial fixing of the inner ring.
- Pull the overrunning clutch off the machine shaft, using a suitable lifting tool if necessary.
- Turn the overrunning clutch by 180° and slide it onto the oiled machine shaft; if necessary, attach suitable lifting gear to the lifting thread of the inner ring for this purpose.
- Center the driven or torque-supporting machine element in the outer race.

**NOTE**

Only screw quality 10.9 may be used!

- Fix the driven or torque-supporting machine element with appropriate fastening screws (e.g. according to standard DIN EN ISO 4762) and screw quality 10.9, tightening torque see Tab. 3 Tightening torques.
- Fix the inner race axially.
- Check overrunning. The one-way clutch must be able to be turned easily in the overrun direction of rotation.

Freewheel size AA	Screw size	Strength- Class 10.9 [Nm]
12 bis 25	M5	9.5
30 bis 35	M6	16.5
40 bis 50	M8	40.1
55 bis 80	M10	79.0
90	M12	137.0
100 bis 120	M16	338.0
150	M20	661.0
200	M24	1136.0
250	M30	2274.0

Tab. 3 Tightening torques

6.3 Lubrication

One-way clutches AA are delivered without lubrication.

Depending on the intended purpose, it is necessary to provide adequate lubrication (see Chapter 2.5. Limitations of use), before taking the one-way clutch into operation.

6.3.1 Operation with oil lubrication

Before operating the oil level inside the one-way clutch should be at least 1/3 to maximum half the one-way clutch height (see Chapter 2.5 Limitations of use).

i	NOTE	Unsuitable lubricants can negatively affect the one-way clutch functionality! Only use greases approved by Stieber!
----------	-------------	---

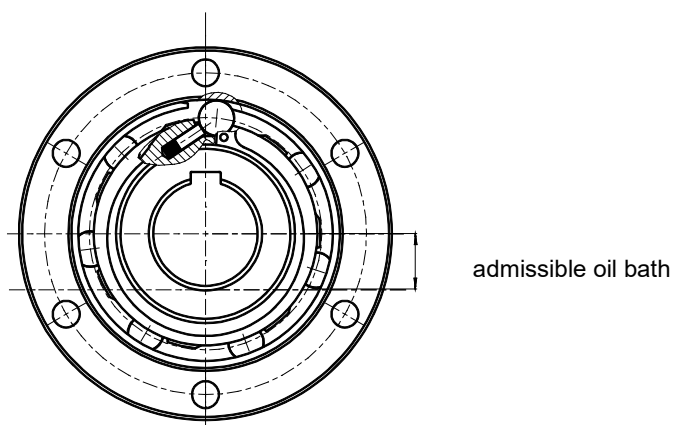

Fig.3 Oil bath

6.3.2 Operation with grease lubrication

In cases where oil lubrication is not possible, it is possible to switch to grease lubrication under the appropriate operating conditions. Select greases and grease quantity according to application limits Tab.1 Specifications.





i	NOTE	Too much grease can impair the function of the one-way clutch!
----------	-------------	--

i	NOTE	Unsuitable lubricants can negatively affect the one-way clutch functionality! Only use greases approved by Stieber!
----------	-------------	---

Procedural steps:

- Place the one-way clutch on an assembly table.
- Use a grease syringe to distribute the specified quantity of grease evenly in the circumferential direction between the two retaining rings (see chapter 2.5 Application limits Tab.1 Specifications).
- Run in the one-way clutch immediately before installation, so that the lubricant is distributed evenly.
- Check overrunning. The one-way clutch must be able to be turned easily in the overrun direction of rotation.

6.4 Assembly

	WARNING	<p>Risk of injury due to incorrect assembly!</p> <p>Incorrect assembly and maintenance can cause severe property damage and personal injury.</p> <p>Assembly, maintenance, and repair work may only be performed by personnel with the requisite training and expertise.</p>
	WARNING	<p>Risk of injury due to moving components!</p> <p>Rotating, driven components can cause severe injuries. Therefore, during operation:</p> <ul style="list-style-type: none"> ➤ It is strictly forbidden for persons to loiter in the hazard area or in its immediate vicinity. ➤ Do not disable, render unusable, or circumvent safety equipment and/or safety functions. <p>Prior to entering the hazard area:</p> <ul style="list-style-type: none"> ➤ Switch off the power supply and secure it against being switched on again. ➤ Wait for still moving components to come to a standstill.
	WARNING	<p>Risk of injury due to falling components!</p> <p>Falling components can lead to serious injuries to persons.</p> <p>Secure the one-way clutch against falling down.</p>
	WARNING	<p>Risk of injury for insufficiently qualified personnel!</p> <p>Improper handling can cause significant personal injury and property damage. Therefore:</p> <ul style="list-style-type: none"> ➤ Only ever have tasks performed by those persons to whom the tasks have been assigned.

Procedural steps:

- Slide the one-way clutch onto the oiled machine shaft; if necessary, attach suitable lifting gear to the lifting thread of the inner ring for this purpose.
- Center the driven or torque-supporting machine element in the outer race
- Fix the driven or torque-supporting machine element with appropriate fastening screws (e.g. according to standard DIN EN ISO 4762) and screw quality 10.9, tightening torque see Tab. 3 Tightening torques.
- Fix the inner race axially.
- Check overrunning. The one-way clutch must be able to be turned easily in the overrun direction of rotation.

**NOTE**

Only screw quality 10.9 may be used!







6.5 Mounting example

Fig. 4: Mounting AA

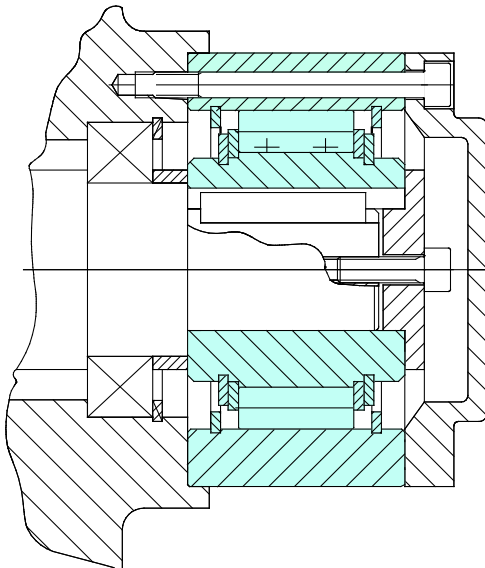
7 Maintenance

	WARNING	<p>Risk of injury due to moving components! Rotating, driven components can cause severe injuries. Therefore, during operation:</p> <ul style="list-style-type: none"> ➤ It is strictly forbidden for persons to loiter in the hazard area or in its immediate vicinity. ➤ Do not disable, render unusable, or circumvent safety equipment and/or safety functions. <p>Prior to entering the hazard area:</p> <ul style="list-style-type: none"> ➤ Switch off the power supply and secure it against being switched on again. ➤ Wait for still moving components to come to a standstill.
	WARNING	<p>Risk of injury due to incorrect assembly! Incorrect assembly and maintenance can cause severe property damage and personal injury. Assembly, maintenance, and repair work may only be performed by personnel with the requisite training and expertise.</p>
	WARNING	<p>Risk of injury due to falling components! Falling components can lead to serious injuries to persons. Secure the one-way clutch against falling down.</p>
	WARNING	<p>Risk of injury for insufficiently qualified personnel! Improper handling can cause significant personal injury and property damage. Therefore:</p> <ul style="list-style-type: none"> ➤ Only ever have tasks performed by those persons to whom the tasks have been assigned.
	WARNING	<p>Danger of scalding due to hot surfaces! There is a risk of burns and danger of scalding during operation due to hot surfaces. Therefore:</p> <ul style="list-style-type: none"> ➤ Do not touch one-way clutches during operation!

7.1 Oil change

First oil change is required after approx. 2,000 operating hours or after one year at the latest. In very dirty environments, the interval is reduced to 5,000 operating hours.

Check lubrication conditions from time to time, flush with thin flushing oil if necessary and change oil. Important at operating temperatures above 80° Celsius.



NOTICE

The local provisions regarding the disposal of waste oil must be observed.

7.2 Maintenance when using grease lubrication

The one-way clutches must be removed, cleaned and re-greased at least every 2 years.

At the time, however, check condition of all parts affected and replace if necessary.

It is recommended to return the set to the manufacturer's works for overhaul.

Procedural steps:

- Loosen the fastening screws of the outer ring (1) and the driven or torque-supporting machine element.
- Remove the axial fixing of the inner race.
- Pull the one-way clutch from the machine shaft. Use suitable lifting gear for this.
- Remove the retaining ring of the outer race.
- Lift the inner race including the rollers out of the outer race (1) up to half the rollers is becoming visible.
- Fix the rollers with a rubber band and remove the outer race. Then remove the single rollers with springs carefully from the inner race.
- Preclean all components with a petroleum-based industrial cleaning agent and degrease with an acetone-based cleaning agent.
- Place the spring-loading into the bore hole of the inner race and fix the rollers with a rubber band. Repeat the procedure until all rollers with spring-loading are firmly positioned on the inner race.
- Grease the outer race track and the fix rollers with a defined grease amount (see Chapter 2.5 Limitations of use Table 1 Specification).
- Insert the inner race with fixed rollers into the outer race until half of the roller is covered.
- Remove the rubber band and lower the outer race completely over the rollers.

8 Disassembly

	WARNING	<p>Risk of injury due to incorrect assembly! Incorrect assembly and maintenance can cause severe property damage and personal injury. Assembly, maintenance, and repair work may only be performed by personnel with the requisite training and expertise.</p>
---	----------------	---

	WARNING	<p>Risk of injury due to moving components! Rotating, driven components can cause severe injuries. Therefore, during operation:</p> <ul style="list-style-type: none"> ➤ It is strictly forbidden for persons to loiter in the hazard area or in its immediate vicinity. ➤ Do not disable, render unusable, or circumvent safety equipment and/or safety functions. <p>Prior to entering the hazard area:</p> <ul style="list-style-type: none"> ➤ Switch off the power supply and secure it against being switched on again. ➤ Wait for still moving components to come to a standstill.
---	----------------	---

	WARNING	<p>Risk of injury due to falling components! Falling components can lead to serious injuries to persons. Secure the one-way clutch against falling down.</p>
---	----------------	---

Procedural steps:

- Remove the axial fixing of the inner race
- Pull the one-way clutch from the machine shaft. Use suitable lifting gear for this

9 Disposal

	NOTICE	<p>The local provisions regarding the disposal of metallic components and any lubricants present are to be observed.</p>
---	---------------	--

The one-way clutch is comprised of metallic materials that are coated with grease or oil. Metallic materials are fully recyclable. Lubricants and anticorrosive agents are to be disposed of separately. The local disposal provisions are to be observed in this regard.

10 Faults

The manufacturer is to be contacted immediately should any faults arise.

STIEBER GMBH, D-69126 Heidelberg, Hatschekstr. 36, Germany
Phone +49 (0) 6221 3047-0, Fax -31

11 Spare parts

	WARNING	Risk of injury due to incorrect spare parts! Incorrect or faulty spare parts can cause damage, malfunctions or total failure as well as impair safety. Therefore: ➤ Only use original spare parts from the manufacturer.
---	----------------	--

Procure spare parts only from authorized dealers or from the manufacturer directly.