

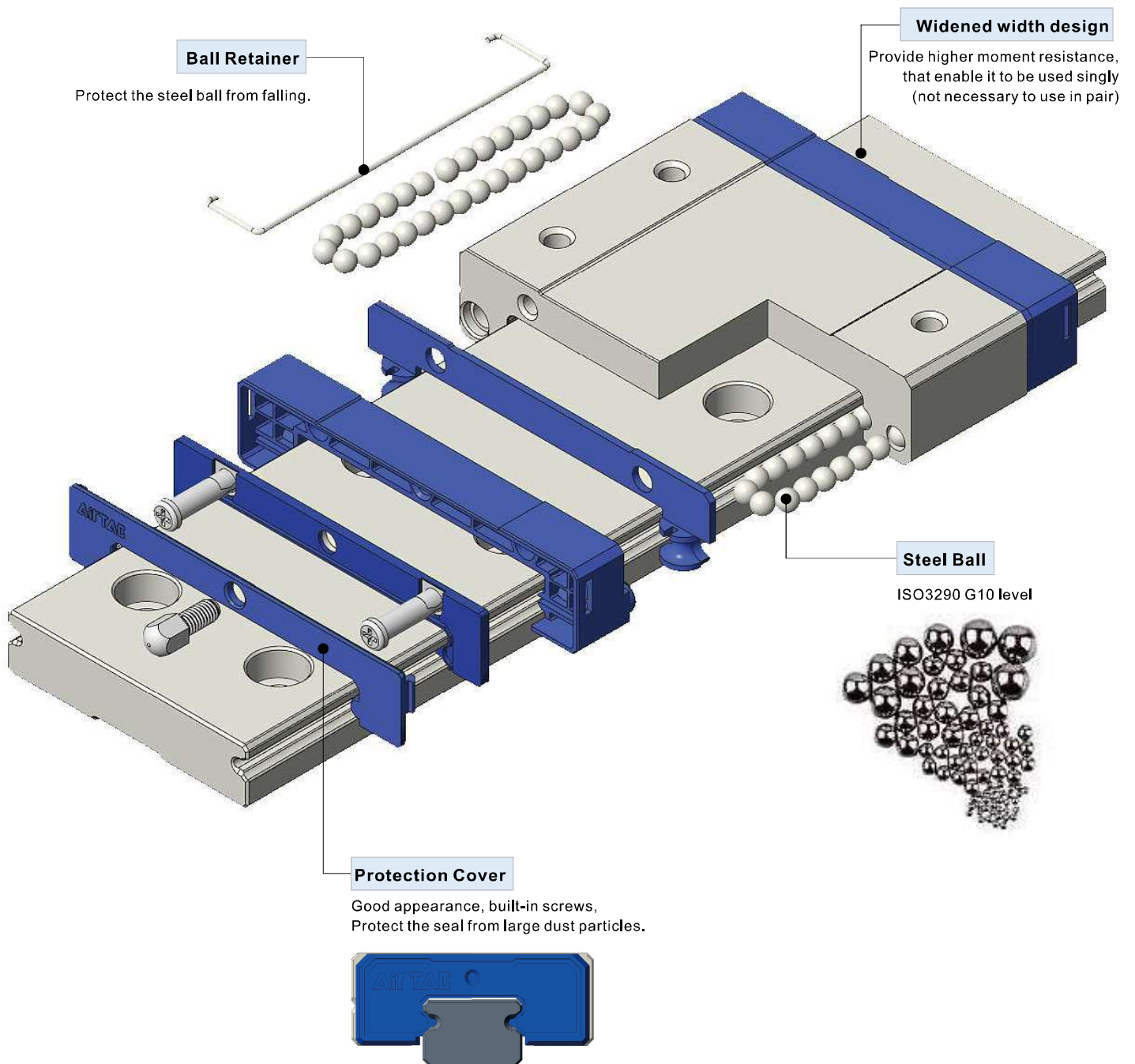

# LRW Series Miniature Linear Guide (Widened)

## Product Introduction



# Miniature Linear Guide (Widened)

## LRW Series



### Order Information(Combined)

LRW □ 7 N 1 X40 S5 A H T

① ② ③ ④ ⑤ ⑥ ⑦ ⑧ ⑨ ⑩

① Model Code	LRW: Miniature Linear Guide (Widened)
② Rail&Block surface treatment	Blank: without additional coating. (natural color) ★BB: Block and rail coated with black chrome
③ Rail Width	7: 14mm    9: 18mm    12: 24mm    15: 42mm
④ Block type	N: Standard    L: Long
⑤ Number of Block	1: One    2: Two [Note: Amount of block on a single set of linear guide]
⑥ Length of Rail	40: 40mm .....[Defined by customer]
⑦ Position of first mounting hole	S□ : Distance from end of rail to the center of first mounting hole (It is recommended to be greater than minimum margin) [Refer to rail spec. Table for details]
⑧ Preload	A: Standard clearance    B: Light Preload    C: Medium Preload
⑨ Accuracy	N: Normal    H: High    P: Precision
⑩ Rail type	Blank: Top-mount    T: Bottom-mount

### Butt-jointed Order Information

LRW □ 7 N 1 X1030 T 1030 A H T

① ② ③ ④ ⑤ ⑥ ⑦ ⑧ ⑨ ⑩ ⑪

① Model Code	LRW: Miniature Linear Guide (Widened)
② Rail&Block surface treatment	Blank: without additional coating. (natural color) ★BB: Block and rail coated with black chrome
③ Rail Width	7: 14mm    9: 18mm    12: 24mm    15: 42mm
④ Block type	N: Standard    L: Long
⑤ Number of Block	1: One    2: Two [Note: Amount of block on a single set of linear guide]
⑥ Length of first Rail	1030: 1030mm .....[Defined by customer]
⑦ Butt-jointed mark	T: Rail Butt-jointed mark (Butt-jointed end margin:1/2P) [P is the standard hole distance]
⑧ Length of second Rail	1030: 1030mm .....[Defined by customer]
⑨ Preload	A: Standard clearance    B: Light Preload    C: Medium Preload
⑩ Accuracy	N: Normal    H: High
⑪ Rail type	Blank: Top-mount    T: Bottom-mount

Butt-jointed end margin: 1/2P ,  
Position of the first and last  
hole is defined by customer.

[Note 1] Number of joints cannot be more than 2 times. Customization is needed for joint times more than standard.

[Note2] Customization is needed is the first/last mounting hole position is out of range in 'Rail Specification Table'.

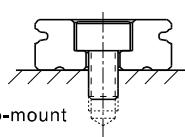

Blank: Top-mount

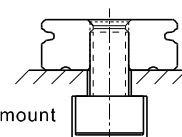

T: Bottom-mount

# Miniature Linear Guide (Widened)

## LRW Series

### 1. Block Order Information

LRW □ 7 BK - N - H - D



[Note1] When selecting rails and bearings, the different pairing codes can change the units preload, details see "preload pairing chart".

① Model Code	LRW: Miniature Linear Guide (Widened)
② Coating on block	Blank: Block without additional coating. (natural color) ★B: Block coated with black chrome
③ Rail Width	7: 14mm 9: 18mm 12: 24mm 15: 42mm
④ Block Code	BK: Block
⑤ Block type	N: Standard L: Long
⑥ Accuracy	N: Normal H: High
⑦ Group code	B C D E [Note1]

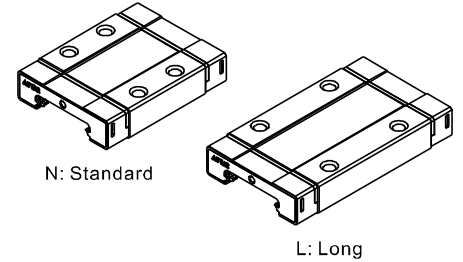

### 2. Rail Order Information

LRW □ 7 RLX2000 - H - E - T

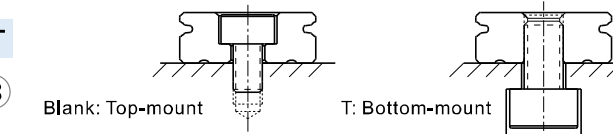

① Model Code	LRW: Miniature Linear Guide (Widened)
② Coating on rail	Blank: Rail without additional coating. (natural color) ★B: Rail coated with black chrome
③ Rail Width	7: 14mm 9: 18mm 12: 24mm 15: 42mm
④ Rail Code	RL: Rail
⑤ Rail Length	7: 2020mm 9: 2020mm 12: 2020mm 15: 2020mm
⑥ Accuracy	N: Normal H: High
⑦ Group code	E [Note1]
⑧ Rail type	Blank: Top-mount T: Bottom-mount

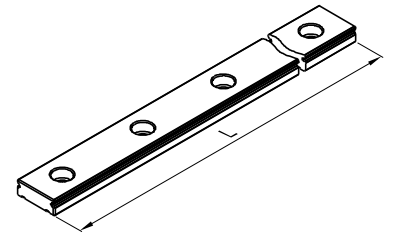

[Note1] When selecting rails and bearings, the different pairing codes can change the units preload. details see "preload pairing chart".

### 3. Rail Order Information

LRW □ 7 RLX40-S5 - H - E - T



[Note1] When selecting rails and bearings, the different pairing codes can change the units preload. details see "preload pairing chart".

① Model Code	LRW: Miniature Linear Guide (Widened)
② Coating on rail	Blank: Rail without additional coating. (natural color) ★B: Rail coated with black chrome
③ Rail Width	7: 14mm 9: 18mm 12: 24mm 15: 42mm
④ Rail Code	RL: Rail
⑤ Rail Length	40: 40mm .....[Defined by customer]
⑥ Position of first mounting hole	S <sub>0</sub> : Distance from end of rail to the center of first mounting hole (It is recommended to be greater than minimum margin) [Refer to rail spec. Table for details]
⑦ Accuracy	N: Normal H: High
⑧ Group code	E [Note1]
⑨ Rail type	Blank: Top-mount T: Bottom-mount

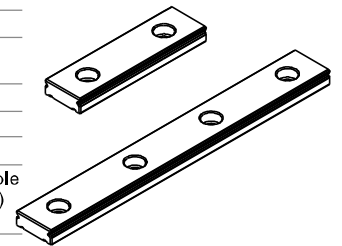

### 4. Accessory(Bolt hole plug)Order Code

L - BC - M3 - 10P



Note: 1. Bolt hole plugs are packed in one bag per 10pcs. EX: When ordering 1pc of "L-BC-M3-10P", it comes with 10pcs plugs;  
2. "L-BC-M3-10P" is applied to LRW7/9 series, "L-BC-M4-10P" is applied to LRW12/15 series.  
3. When mounting plugs for LRW7/12/15 series, short head bolts are required, bolt size is shown in the following figure.

① Accessory	L: Linear Guide Accessories
② Plug Code	BC: Bolt hole plug
③ Plug Specification	M3: Used for M3 bolt M4: Used for M4 bolt
④ Plug quantity	10P: 10pcs/bag

Model	A
LRW7	≤2
LRW12	≤2.6
LRW15	≤2.6

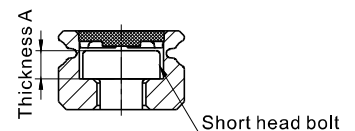

### 5. Rail/Block preload pairing chart

When customer orders rail/block, please choose the pairing code of rail/block in accordance with the needed preload of linear guide(combined). Details please refer to the "preload pairing chart".

Model	Rail pairing code	Block pairing code	Preload grade	Model	Rail pairing code	Block pairing code	Preload grade
LRW7 LRW9	E	B	-	LRW12 LRW15	E	B	Medium preload
		C	Medium preload			C	Light preload
		D	Light preload			D	-
		E	Standard clearance			E	Standard clearance

# Miniature Linear Guide (Widened)

## LRW Series

### Rail Specification

- Please refer to the chart for maximum individual rail length and Edge pitch information.
- The edge pitch of first mounting hole (S) and last mounting hole (E) should not be greater than 1/2P. Overlong edge may induce unstable installation and affect the accuracy.  
n: Numbers of mounting holes

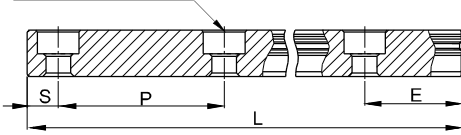

$L = (n-1) \times P + S + E$       P: Distance between bolt holes(mm)  
 L: Total length of rail(mm)      S: Edge of first mounting hole(mm)  
 n: Numbers of mounting holes on rail      E: Edge of last mounting hole(mm)

Model	LRW7	LRW9	LRW12	LRW15
Pitch(P)	30	30	40	40
2m Standard Edge Pitch(S)	20	20	30	30
2m Standard Edge Pitch(E)	20	20	30	30
Min. Edge Pitch(S/E min)	4	4	5	5
Max. Edge Pitch(S/E max)	26	26	35	35
Maximum length(Lmax)	2020	2020	2020	2020

Note:

- Joint rail must be chosen if length of rail exceeds the maximum.
- When deciding edge pitch, it should be within the range of above table. There would be risk of broken hole if pitch is out of range.
- Maximum length of rail for standard means the maximum length of rail can be chosen when both sides of edge pitches are standard.

### Specifications and Dimensions

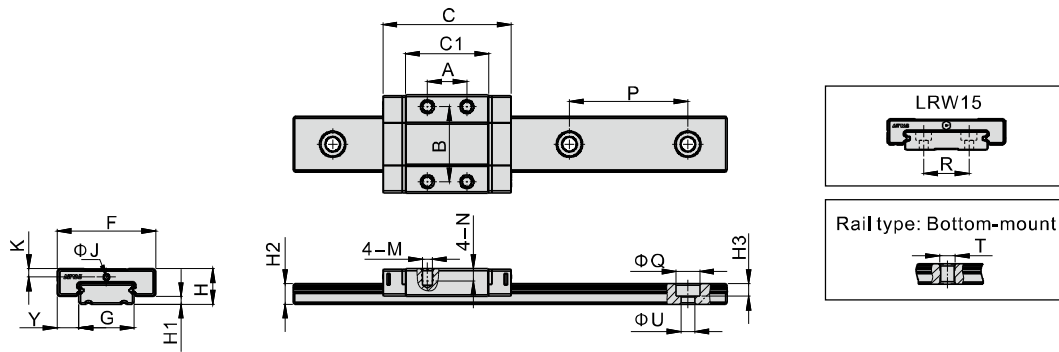

Model\Item	External Dimension ( mm )					Block Dimension ( mm )							Rail Dimension ( mm )							
	H	H1	F	Y	C	C1	A	B	M	N	K	J	G	R	H2	P	ΦQ	ΦU	H3	T
LRW7N	9	1.9	25	5.5	32.5	21	10	19	M3X0.5	3	2.15	1.2	14	-	5.2	30	6	3.5	3.2	M4X0.7
LRW7L	9	1.9	25	5.5	42	30.5	19	19	M3X0.5	3	2.15	1.2	14	-	5.2	30	6	3.5	3.2	M4X0.7
LRW9N	12	3	30	6	40	27.5	12	21	M3X0.5	3	2.85	1.2	18	-	7.3	30	6	3.5	4.5	M4X0.7
LRW9L	12	3	30	6	52	39.5	24	23	M3X0.5	3	2.85	1.2	18	-	7.3	30	6	3.5	4.5	M4X0.7
LRW12N	14	3	40	8	46	31	15	28	M3X0.5	3.5	3.15	1.2	24	-	8.5	40	8	4.5	4.5	M5X0.8
LRW12L	14	3	40	8	61	46	28	28	M3X0.5	3.5	3.15	1.2	24	-	8.5	40	8	4.5	4.5	M5X0.8
LRW15N	16	2.7	60	9	57.5	39.3	20	45	M4X0.7	4.5	3.45	M3	42	23	9.5	40	8	4.5	4.5	M5X0.8
LRW15L	16	2.7	60	9	76.5	58.3	35	45	M4X0.7	4.5	3.45	M3	42	23	9.5	40	8	4.5	4.5	M5X0.8

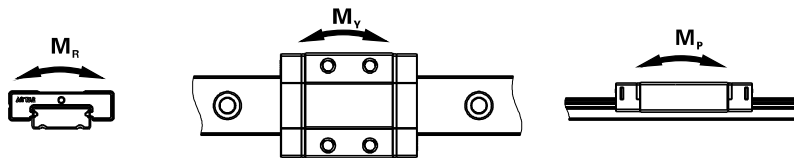

Model\Item	Mounting Screw	Dynamic Load Rating(kN)	Static Load Rating(kN)	Static Rated Moment (N.m)			Weight	
		C <sub>100B</sub>	C <sub>0</sub>	M <sub>R</sub>	M <sub>P</sub>	M <sub>V</sub>	Block(kg)	Rail(kg/m)
LRW7N	M3	1.07	1.96	14.92	6.78	6.78	0.022	0.505
LRW7L	M3	1.47	2.98	22.28	14.75	14.75	0.030	0.505
LRW9N	M3	2.03	3.91	38.11	18.01	18.01	0.041	0.933
LRW9L	M3	2.69	5.60	51.81	32.30	32.30	0.055	0.933
LRW12N	M4	3.13	5.31	85.82	26.41	26.41	0.073	1.492
LRW12L	M4	4.08	7.83	97.57	54.50	54.50	0.105	1.492
LRW15N	M4	5.26	8.76	189.37	53.83	53.83	0.154	2.885
LRW15L	M4	6.99	12.71	284.06	116.47	116.47	0.223	2.885

# Miniature Linear Guide (Widened)

## LRW Series

### Accuracy

LRW standard type linear guide comes with 3 accuracy levels.

Accuracy Standards (mm)	Accuracy Standards (mm)			
	Accuracy	N : Normal	H: High	P: Precision
Tolerance of height H	±0.04	±0.02	±0.01	
Variation of height ΔH	0.03	0.015	0.007	
Tolerance of width Y	±0.04	±0.025	±0.015	
Variation of width ΔY	0.03	0.02	0.01	

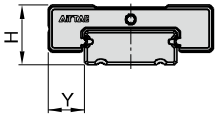

Parallelism of the raceway

Accuracy Rail Length(mm)	Parallelism of the raceway(μm)		
	N	H	P
50 under	12	6	2
50~80	13	7	3
80~125	14	8	3.5
125~200	15	9	4
200~250	16	10	5
250~315	17	11	5
315~400	18	11	6
400~500	19	12	6
500~630	20	13	7
630~800	22	14	8
800~1000	23	16	9
1000~1200	25	18	11
1200~1300	25	18	11
1300~1400	26	19	12
1400~1500	27	19	12
1500~1600	28	20	13
1600~1700	29	20	14
1700~1800	30	21	14
1800~1900	30	21	15
1900~2000	31	22	15
2000-	31	22	16

### Preload Level

The LRW standard type Linear Guide has three preload categories: A, B and C.

Choosing suitable preload level will enhance rigidity, precision and torsion resistant performance of the linear guide.

Preload	Code	Radial interference (μm)				Application
		7	9	12	15	
Standard clearance	A	-2~+2	-2~+2	-2~+3	-2~+3	Smooth operation
Light Preload	B	-4~-2	-5~-2	-6~-2	-7~-2	High precision
Medium Preload	C	-7~-3	-8~-4	-9~-5	-10~-6	High rigidity

### Load Capacity and Rating Life

#### 1. Basic static load rating (C<sub>0</sub>)

It is defined as the static load when the total permanent deformation of the steel ball and the surface of the groove is exactly one ten-thousandth of the diameter of the steel ball under the state of the load direction and size unchanged.

#### 2. Allowable static moment (M<sub>0</sub>)

When the steel ball subjected to the maximum stress in the slider reaches a static rated load condition, this loading moment is called the "Static permissible moment". The definition comes in three directions.

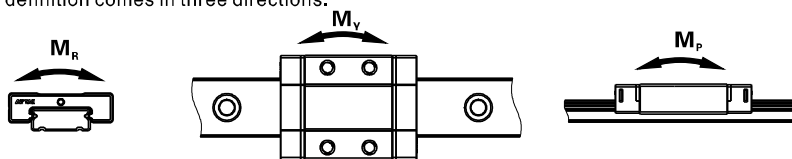

#### 3. Static safety factor (f<sub>s</sub>)

Impact, vibration and inertial loading during start and stop moment lead to unexpected load on the linear guide way.

Therefore, when calculating the static load, safety factors must be considered.

Load Condition	f <sub>s</sub>
Normal Load	1.0~2.0
Load with Impacts or Vibrations	2.0~3.0

$$f_s = \frac{C_0}{P} = \frac{M_0}{M}$$

f<sub>s</sub> : Static safety factor

C<sub>0</sub> : Basic static load rating (N)

M<sub>0</sub> : Static permissible moment (N.m)

P : Calculated working load (N)

M : Calculated applying moment (N.m)

#### 4. Load factor (f<sub>v</sub>)

The loads acting on a linear guide way include the weight of block, the inertia load at the times of start and stop, and the moment loads caused by overhanging. Therefore, the load on a linear guide way should be divided by the empirical factor.

Loading condition	Use speed	f <sub>v</sub>
No impacts & vibration	V ≤ 15m/min	1~1.2
Small impacts	15m/min < V ≤ 60m/min	1.2~1.5
Normal load	60m/min < V ≤ 120m/min	1.5~2.0
With impacts & vibration	V > 120m/min	2.0~3.5

#### 5. Basic dynamic load rating (C<sub>100B</sub>)

C<sub>100B</sub> : (According to ISO 14728-1) As the direction and magnitude remains the same, C<sub>100B</sub> is the maximum workload for the product to maintain its nominal life at 100km of operation.

## LRW Series

### 6. Calculation of Nominal Life(L)

Recognizing that nominal life of a linear guide is affected by the actual working loads, the general calculation of the nominal life excluding the environmental factors is carried out as follow: :

$$L = \left( \frac{C_{100B}}{f_w \times P} \right)^3 \times 10^5$$

L = Nominal Life (m)

C<sub>100B</sub> = Dynamic Load Rating (N)

f<sub>w</sub>: Load Factor

P = Equivalent load (N)

Taking LRW9N for example, its C<sub>100B</sub> is 2.03kN. Therefore, when the product bears a 1.5kN equivalent load P, f<sub>w</sub>=1, its theoretical rated life can be calculated as follows:

$$L = \left( \frac{C_{100B}}{f_w \times P} \right)^3 \times 10^5 = \left( \frac{2.03}{1 \times 1.5} \right)^3 \times 10^5 = 247865 \text{ m} = 247.9 \text{ km}$$

## Installation Illustration

### 1. Height and Chamfer of Reference Edge

In order to ensure accurate installation of LRW Linear Guide, the contact space should not exceed the given figures in following table.

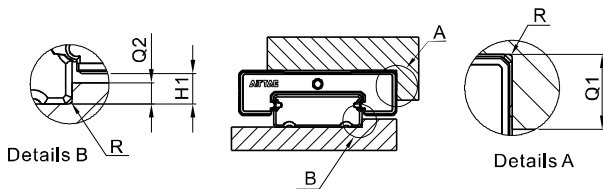

Unit : mm

Model	Q1	Q2	H1	R(Max)
LRW7	3	1.6	1.9	0.2
LRW9	3	2.7	3	0.3
LRW12	4	2.7	3	0.4
LRW15	5	2.4	2.7	0.5

### 2. Screw Tighten Torque

When installing linear guide, whether the screws are well tighten and surface is well contacted will affect accuracy significantly. Please refer to following table for tightening force to ensure a perfect installation.

Model	Screw size	Tighten Torque(N.cm)		
		Iron	Casting	Aluminum alloy
LRW7	M3	196	127	98
LRW9	M3	196	127	98
LRW12	M4	412	274	206
LRW15	M4	412	274	206

### 3. Datum plane

- Datum plane for installation must be ground or finely milled to ensure accuracy.
- Both sides of Rail can be used as the datum plane.
- For multi-blocks on a rail, identification line on blocks should be put on the same side to ensure moving accuracy.

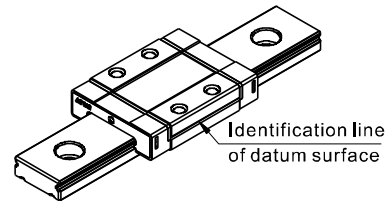

## Rail Butt-jointed

- When jointing rails, it must follow group marks on rail to ensure the accuracy of linear guide. These marks are located on the top surface at joint side. Please put the same group marks together.

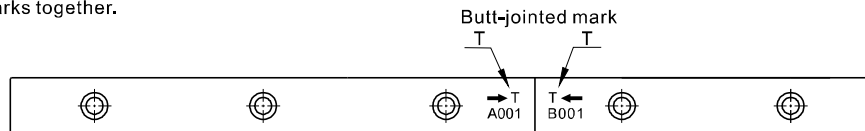

- Be aware serial number of group mark when assemble. A001 and B001 are in a group, so as to A002 and B002 and so on.
- Be aware the installation direction while assembly, the serial numbers are not upside down and arrows point to each other.

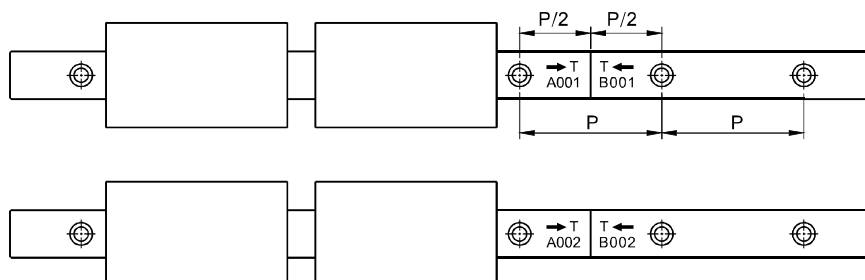

# Miniature Linear Guide (Widened)

## LRW Series

### Lubrication method

When a linear guide is well lubricated, it can reduce wear and increase lifespan significantly. Lubrication has the following benefits :

- Reduces friction of the rollers and raceway to minimize wear.
- The grease film between contact surface can prevent roller fatigue.
- Prevent rust.

#### 1. Lubrication method

LRW series linear guide is well lubricated with 'Shell Alvania grease S2' in factory.

Customers are recommended to use identical or the same grade of lubricant.

Refer to table on the right for suggested amount:

In order to be well lubricated, the blocks need to be moved back and forth while lubricating.

Lubrication can be done either by manual or automatic device.

Model	Grease amount for the first lubrication(cm <sup>3</sup> )	Replenishment amount(cm <sup>3</sup> )
LRW7N	0.17	0.09
LRW7L	0.2	0.1
LRW9N	0.27	0.14
LRW9L	0.36	0.18
LRW12N	0.45	0.23
LRW12L	0.6	0.3
LRW15N	0.81	0.41
LRW15L	1.06	0.53

#### 2. Lubrication frequency

Although the linear guides are well lubricated at the factory and retains grease well,

frequent lubrication is still necessary to avoid undesirable wear.

Recommended lubrication period is every 100km of movement or every 3~6 months.

(Refer to table on the right for suggested amount)

### Precautions on use

#### 1. Block disassembly

With ball retainers, normally the balls are prevented from falling out when block is removed from rail.

However, if obliquely insert rail into blocks or quickly assembled or disassembled, there is a risk for balls of falling out.

Please carefully assemble the linear guide or use plastic rails to assist.

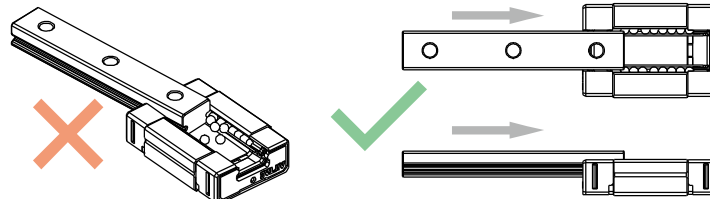

#### 2. Caution

- Parts may slide out if linear guide is put unevenly. Please be careful.
- Hitting or dropping linear guide could have huge effect on accuracy and lifespan even though appearance may remain intact. Please be careful.
- Do not disassemble linear guide as external objects may enter blocks and cause accuracy problem.

#### 3. Lubrication

- Linear guide have been treated with anti-rust oil during production. Before use, wipe the rail and treat it with lubrication.
- Do not mix lubricating oil (grease) with different properties.
- After lubrication, move block back and forth for the length of three blocks long and repeat at least 2 times to ensure there is a grease film on rail.

#### 4. Use

- The operating environment temperature should not exceed 80°C, and the maximum temperature should not exceed 100°C.
- Do not separate blocks from rail whenever it is not necessary. If you need to separate them, please use plastic rails to prevent steel balls from falling out.

#### 5. Storage

- When storing blocks, rails or linear guide set, please be sure that anti-rust oil is well applied and product is well sealed as well as placed horizontally. Avoid humidity and high temperatures environment.