

Technical Information

# Steering

## EHi Steering Valve

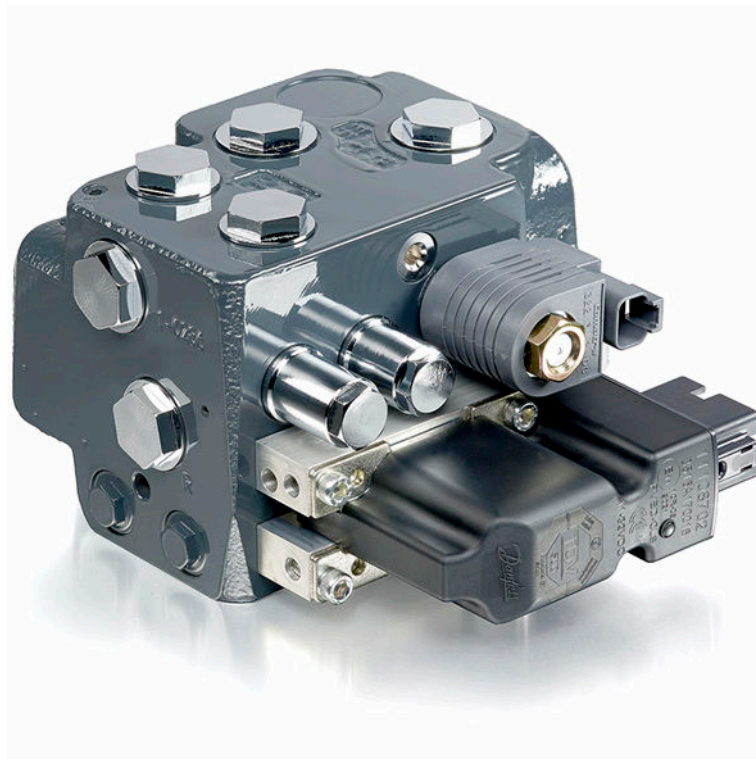

**Revision history**

*Table of revisions*

<b>Date</b>	<b>Changed</b>	<b>Rev</b>
March 2022	Updated master model code section to align with the Design Center configurator	0401
July 2020	Updated document number to match online catalog.	0305
	Changed document number from 'BC00000379' to 'BC220386485094'	XX
January 2018	Function, Technical Characteristics, Coding ; minor corrections and additions	0202
April 2017	Updated some function drawings; added to EHi and system safety; Corrected Code numbers specifications; and minor corrections	0201
January 2017	First edition	0101

**Contents**

**Overview**

A wide range of steering components..... 4  
 Survey of literature on Danfoss steering components..... 5  
 Electrohydraulic Steering Valve..... 6

**Versions**

Versions, overview..... 7  
     Parts and variants..... 7  
     Steering concept..... 7  
     Disengage of EH steering..... 8  
     Actuation of EHi steering valve..... 8  
     Priority valve..... 8  
     Pilot relief valve..... 8  
     Shock valves..... 8  
 Versions, examples..... 9  
     EHi for Load Sensing Non-Reaction steering system..... 9  
     EHi for Open Center Non-Reaction steering system..... 11  
     EHi for Load Sensing Reaction steering system..... 12  
     EHi for Steer by Wire steering system..... 14  
     EHi for Hydraulic Disengage..... 15

**Function**

Main components..... 17  
 EHi xx LD R E for Reaction type steering unit..... 18  
     Neutral position..... 18  
     Steering Right with EHi..... 20  
     Steering Right with EHi and OSP: variable steer mode..... 22  
 EHi xx LD N E for Non-Reaction type steering unit ..... 23  
     Neutral position..... 23  
     Steering Right with EHi..... 24  
 EHi xx W1 N for Steer by Wire steering..... 26  
     Neutral position..... 26  
     Steering Right with EHi..... 27

**Technical data**

EHi ..... 28  
 Weight..... 28  
 PVE actuation modules..... 28  
 PVE connectors..... 30  
 Coil of control valve for mode select..... 32  
 Electrical specifications..... 32

**Dimensioning steering system**

Steering systems with EHi steering valve..... 34

**Technical characteristics**

EH-directional spools of EHi ..... 35  
 Pilot pressure relief valve, (P - T, Qp) characteristic..... 36  
 Pressure drop, P-EF for EHi valve..... 36

**Dimensions**

EHi with PVED-CLS..... 38

**System safety**

Emergency steering..... 39  
 EHi and system safety..... 39  
 Safety considerations, On-road operation..... 39

**Variants and ordering specifications**

EHi Master Model Code (MMC) breakdown..... 41  
 Code numbers..... 42  
 EHi standard configurations..... 43

## Overview

### A wide range of steering components



Danfoss is one of the largest producers in the world of steering components for hydrostatic steering systems on off-road vehicles. Danfoss offers steering solutions both at component and system levels. Our product range makes it possible to cover applications of all types, ranging from ordinary 2 wheel steering (also known as Ackermann steering) to articulated steering, automatic steering (for example, by sensor) and remote controlled steering via satellite. We can offer more than 1,800 different steering units and 250 different priority valves categorized in types, variants and sizes.

#### Danfoss offers:

*For hydrostatic steering systems:*

Product type	Displacement	Rated Flow	Steering Pressure
<b>Mini steering units</b>	32 – 100 cm <sup>3</sup> /rev [1.95 – 6.10 in <sup>3</sup> /rev]	max. 20 l/min [5.28 US gal/min]	max. 140 bar [2030 psi]
<b>Steering units</b>	40 – 1200 cm <sup>3</sup> /rev [2.44 to 73.2 in <sup>3</sup> /rev]	max. 100 l/min [26.4 US gal/min]	max. 240 bar [3481 psi]
<b>Priority valves</b>	–	40, 80, 120, 160, 320 l/min [10.6, 21.1, 31.7, 42.3, 84.5 US gal/min]	max. 350 bar [5076 psi]
<b>Pilot operated flow-amplifiers (factors: 4, 5, 8, or 10)</b>	–	240 and 400 l/min [63.4 and 105.7 US gal/min]	max. 240 bar [3480 psi]
<b>Pilot operated steering valves</b>	–	max. 100 l/min [26.4 US gal/min]	max. 250 bar [3625 psi]

*For electrohydraulic steering systems*

Product type	Displacement	Rated flow	Steering pressure
<b>Pilot operated steering valves</b>	–	100 l/min [26.4 US gal/min]	250 bar [3625 psi]
<b>Integrated electrically operated steering valve</b>	100 - 500 cm <sup>3</sup> /rev [6.10 - 30.51 in <sup>3</sup> ]	50 l/min [13.2 US gal/min]	210 bar [3045 psi]
<b>Electrically operated steering valve</b>	–	70 l/min [18.5 US gal/min]	250 bar [3045 psi]

## Overview

### Characteristic features for steering units:

- Low steering torque: from 0.5 to 3 N·m in normal steering situations
- Low noise level
- Low pressure drop
- Many types available: Open center Non-reaction, Open center Reaction, Power Beyond, Closed center Non-reaction, Load Sensing, Load Sensing Reaction
- One or more built-in valve functions: relief valve, shock valves, suction valves, non-return valve in P-line and LS-line
- Optional port connections according to ISO, SAE or DIN standards

### Characteristics for EH steering systems with OSPE, EHPS, and EHi:

- Possibility of GPS, row sensor, variable steering ratio and joystick steering
- Possibility of manual steering even on very heavy vehicles
- EHPS:
  - High steering pressure requiring smaller cylinders and flow
  - Low pilot pressure and flow giving extremely low noise in the cabin
  - Combined with Danfoss PVG 32 proportional valve

### Conversion factors

$$1 \text{ N}\cdot\text{m} = [8.851 \text{ lbf}\cdot\text{in}]$$

$$1 \text{ N} = [0.2248 \text{ lbf}]$$

$$1 \text{ mm} = [0.0394 \text{ in}]$$

$$1 \text{ cm}^3 = [0.061 \text{ in}^3]$$

$$1 \text{ l} = [0.264 \text{ US gal}]$$

$$1 \text{ bar} = [14.5 \text{ psi}]$$

$$^{\circ}\text{F} = [1.8^{\circ}\text{C} + 32]$$

## Survey of literature on Danfoss steering components

Detailed data on all Danfoss steering components and accessories can be found in our steering component catalogs, which is divided in to the following individual sub catalogs:

General information	Steering components
Technical data on open center, and closed center steering units	OSPB, OSPC, and OSPD
Technical data on load sensing steering units, priority valves and flow amplifiers	OSPB, OSPC, OSPF, OSPD, OSPDF, OSPL, OSPBX, and OSPLX
Technical data on priority valves	OLS
Technical data on priority flow amplifiers	OSQ
Technical data on valve blocks	OVPL and OVR
Technical data on load sensing steering units with amplification	OSPU
Technical data on steering units with zero dead band	OSPS
Technical data on steering units with integrated priority valve	VSPP
Technical data on hydraulic and EH pilot operated steering valves, electrical actuation modules and appropriate steering units.	EHPS, EHPS w. OLS 320, PVE for EHPS and OSPCX
Technical data on combined steering unit/EH steering valves and steering wheel sensors	OSPE
Technical data on electrohydraulic steering valves	EHi
Technical data on steering wheel sensors	SASA

[For technical information on individual variants, please contact the Danfoss Sales Organization.](#)

## Overview

### Electrohydraulic Steering Valve

On tractors, harvesters, sprayers and other similar vehicles, electrically actuated steering to make auto guidance possible is often needed. Also, manual steering with variable ratio is a preferred feature to improve productivity and driver comfort.

On wheel loaders, fork lift trucks and similar type of vehicles, the productivity and driver comfort can be increased significantly for off road usage, by using joystick or mini wheel for steering.

Danfoss has developed the Electrohydraulic Steering Valve (EHi) for electrohydraulic steering, controlled by electrical input signal either from GPS receiver/controller for auto guidance, or from steering wheel sensor (Danfoss type SASA) for variable steering ratio. In variable steering mode, the electrohydraulic valve adds flow to the metered flow from the OSP steering unit. Alternatively, the EHi can be activated by joystick or mini wheel.

The EHi design supports category 3 architecture according to ISO 13849-1. Fail-safe operation of electrohydraulic steering is achieved by means of two individual spools, both supporting medium diagnostic coverage 90-99%. The EHi is available with PVED-CLS steering valve controller to complete a full CAT3 fail-safe steering valve. The PVED-CLS has steering specific functions, including dedicated safety functions, which may be tailored for most off-road vehicles through software parameterization. The EHi is offered with an independent 3rd party certification and a full steering sub-system specification.

EHi will be the natural choice, if space does not allow to use the combined steering unit and electrohydraulic steering valve, type OSPE. With OSPE, installation will be very easy due to all functions for manual and electrohydraulic steering is integrated in the one and same unit.

The EHi is designed for easy integration with other components in a steering system. EHi manifold ports allows for building a steering system without the use of T fittings.

## Versions

### Versions, overview

#### Parts and variants

Part	Variants						
EH	<b>EHi</b>	Single section Electrohydraulic in-line ( <b>EHi</b> ) steering valve					
EH spool, directional	Cylinder flow, nominal, l/min	12	<b>20</b>	30	40	50	70
Concept	Steering unit type or Steer by Wire	Open center: OC	Closed center: CC	LS dynamic: <b>LD</b>	LS static: LS	Steer by Wire: W1 or W2	
Reaction	Reaction Switch Valve, RSV	Not included: <b>N</b>			Included: R		
Disengage	How to override EH steering	With steering unit:				Steer by Wire: Not relevant	
		Electric signal, from e.g. SASA sensor: <b>E</b>		Hydraulic override from steering unit: H			
PVE Actuation module	Type	PVED CLS SIL 2		PVED CC		PVES	
Coil, Voltage	Voltage, V	12			24		
Priority valve	For pump flow, nominal, l/min	45		90		None if priority valve is not needed inside EHi	
Relief valve	P-T, bar.	Always included: setting value, max 250 bar					
Shock valves	R-T/L-T, bar	Included: setting value, max 308 bar			Not included		

For a list of catalog numbers and example master model codes, see [Code numbers](#) on page 42.

Base type designation, example: **EHi 20 LD N E**

- 20 is referring to nominal cylinder flow, named xx in examples
- LD, N and E is referring to steering concept

#### Steering concept

EHi is offered in various versions to match the base steering unit on the vehicle.

EHi is available for:

- OC: Open Center steering units
- LD: Load Sensing Dynamic steering units
- LS: Load Sensing Static steering units
- N: Non reaction type steering units
- R: Reaction type steering units

EHi is also offered in versions for pure Steer by Wire usage, meaning no hydrostatic steering unit is present in the steering system. EHi is available for:

- W1: EHi in Steer by Wire system

## Versions

### Disengage of EH steering

In any steering system having a hydrostatic steering unit for the base steering, the steering wheel steering must have priority. The concept for deactivating the electrohydraulic steering must be considered and decided. Disengage of EH steering by:

- E: Electric signal detecting steering wheel rotation, for example, from Danfoss steering wheel sensor, type SASA
  - Electrical disengage is recommended
- H: Hydraulic signal from steering unit overrides electrohydraulic steering
  - Disengage of EH steering is available with the PVED-CLS actuator

---

[Variable steer mode is not available when using hydraulic disengage.](#)

---

### Actuation of EHi steering valve

EHi is offered with different types of PVE actuators:

- PVED-CLS: CAN ISOBUS controlled actuator with configurable electrohydraulic steering functionalities such as auto guidance, variable steering ratio, speed dependent characteristics, AUX interface for joystick and electric mini wheel, and with safety functions including controlling the EH cut-off valve. It can also handle up to 3 analogue inputs. See *OSPE with PVED-CLS Steering Valve Controller Data Sheet, AI152986484866* for further details. PVED-CLS is recommended as actuator for EHi.
- PVED-CC: CAN ISOBUS controlled actuator without dedicated software for steering. See *PVED-CC, Series 5 ISObus Technical Information, BC159886484234* for further details. To be used if EH steering functionalities and steering safety must be controlled by external controller, for example, vehicle main controller.
- PVEs: Ratio metric analog voltage controlled actuator without dedicated software for steering. See *PVE Series 7 Technical Information, BC218286485446* for further details.

### Priority valve

EHi is offered with and without integrated priority valve.

### Pilot relief valve

Pilot relief valve is present in any EHi. Internal connection of pilot relief valve inside EHi is dependent on the pilot relief valve being present in the steering unit or not.

### Shock valves

EHi is offered with or without shock and suction valves. Shock and suction valves are needed if they are not present elsewhere in the steering system. If shock and suction valves are present in the steering system, and always connected to the cylinder ports, additional shock and suction valves inside the EHi will not be needed. Activation of shock valves may produce an audible noise.



**Versions**

**Versions, examples**

**EHi for Load Sensing Non-Reaction steering system**

***EHi xx LD NE***

This version is to be used in steering systems with LS Dynamic Non-Reaction steering unit and using SASA sensor for electrical disengage of EH steering. EH steering will be disabled, when the electric power is shut down for the solenoid valve (SOL).

***Configuration number: EHi-1***

*No internal priority valve*

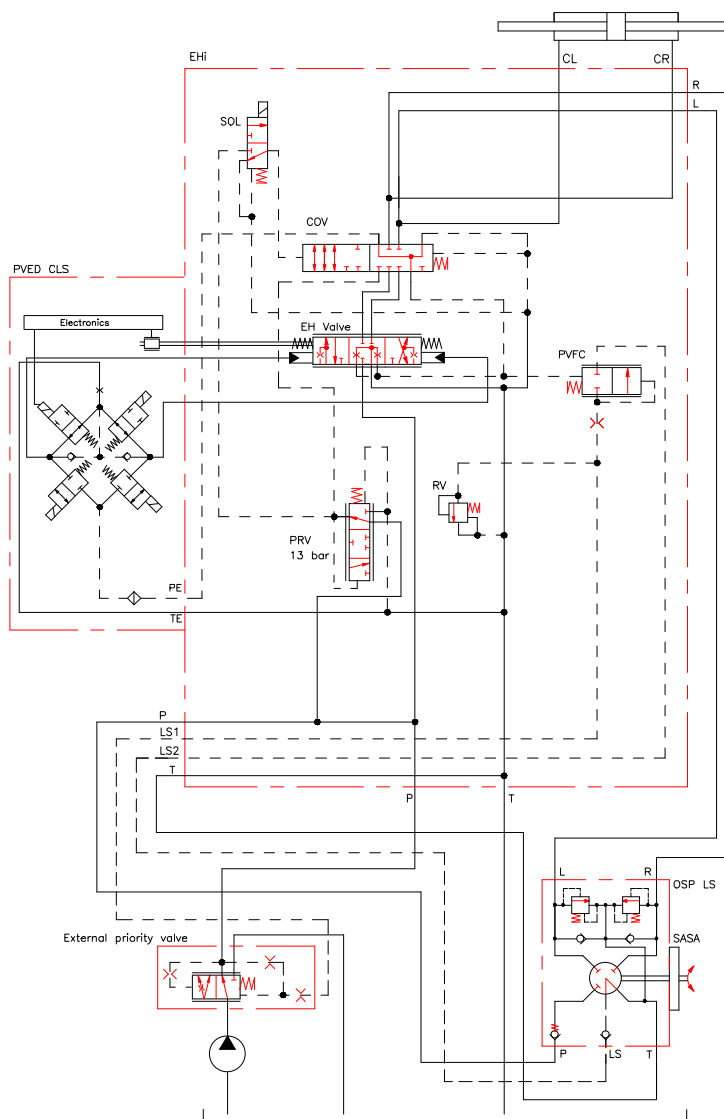

**Versions**

**Configuration number: EHi-4**

*Internal priority valve and EF-T connection*

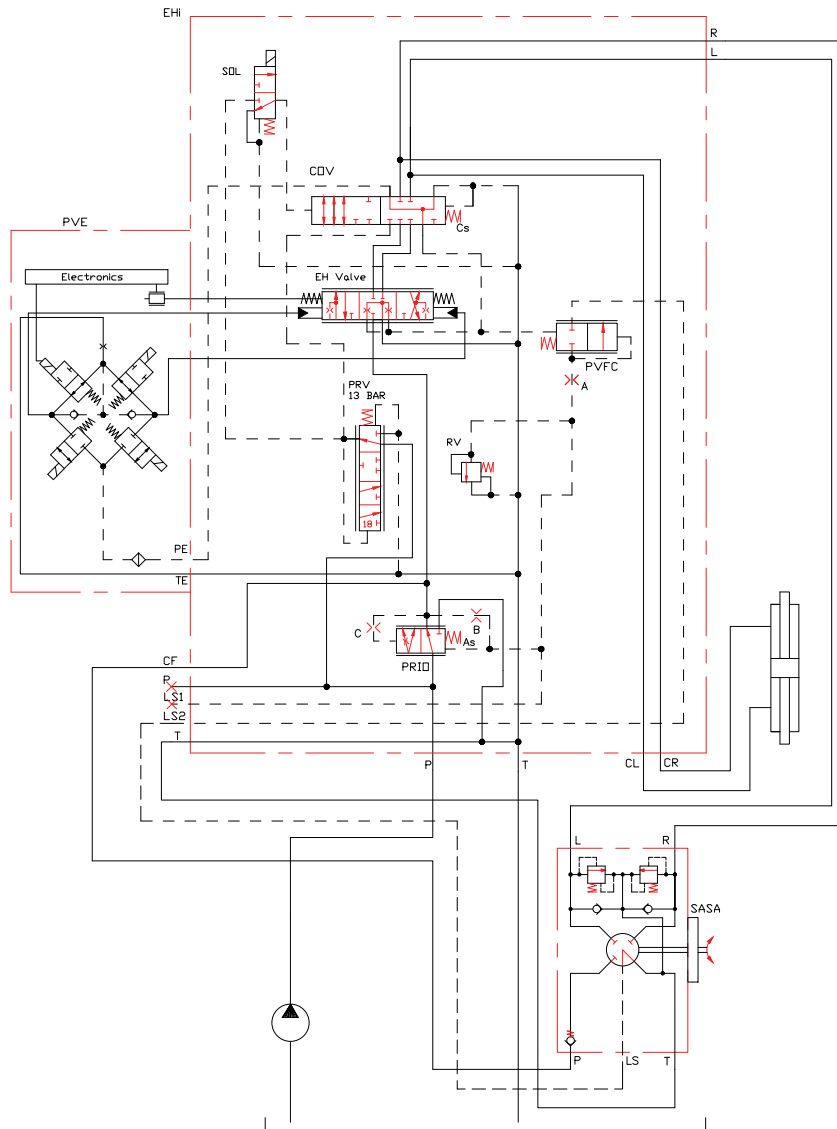

**Versions**

**EHi for Open Center Non-Reaction steering system**

***EHi xx OCNE***

This version is to be used in steering systems with Open Center Non-Reaction steering unit and using SASA sensor for electrical disengage of EH steering. A priority valve is present inside EHi steering valve. The priority valve is needed to generate stand by pressure across the EH directional valve. EH steering will be disabled, when the electric power is shut down for the solenoid valve (SOL).

***Configuration number: EHi-2***

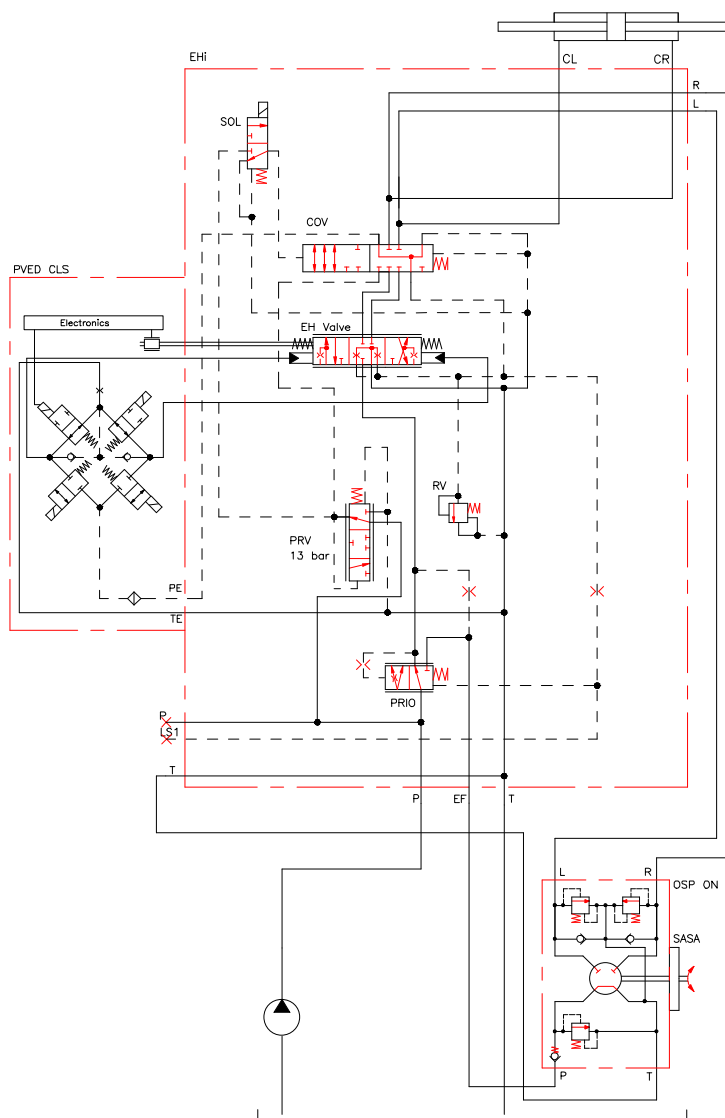

**Versions**

**EHi for Load Sensing Reaction steering system**

***EHi xx LDRE***

This version is to be used in steering systems with LS Dynamic Reaction steering unit and using SASA sensor for electrical disengage of EH steering. Priority valve is needed inside EHi steering valve, when no priority valve is present elsewhere. EH steering will be disabled, when the electric power is shut down for the solenoid valve (SOL).

***Configuration number: EHi-5***

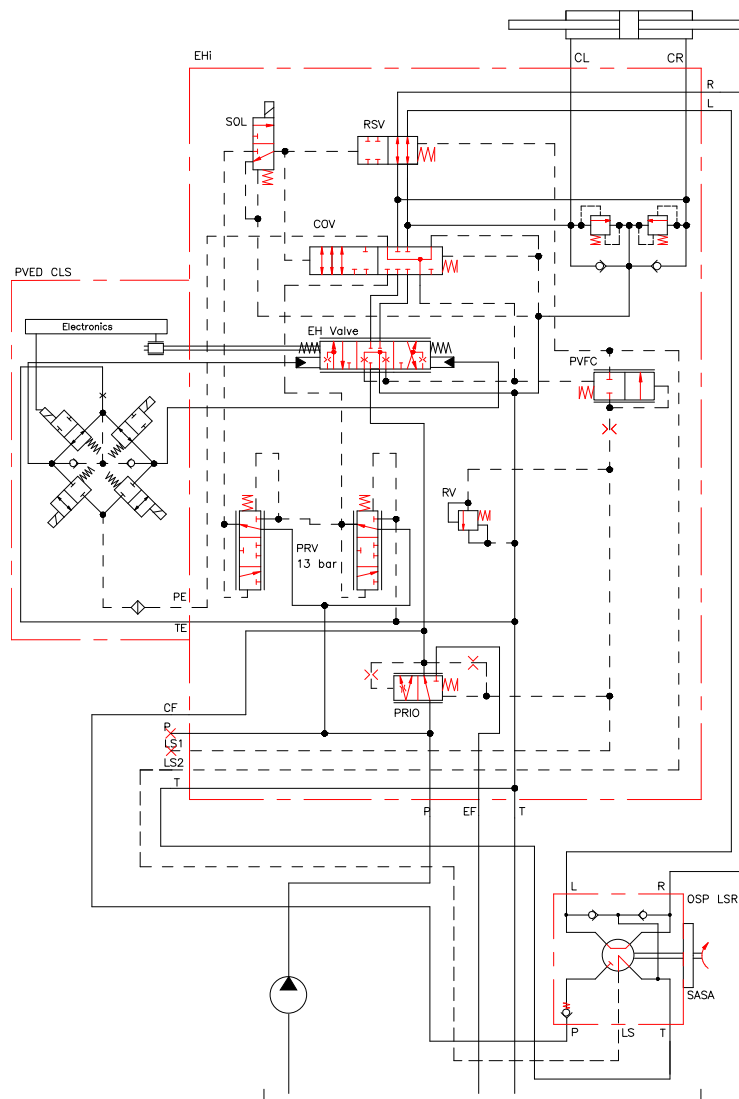

**Versions**

**Configuration number: EHi-6**

No internal priority valve

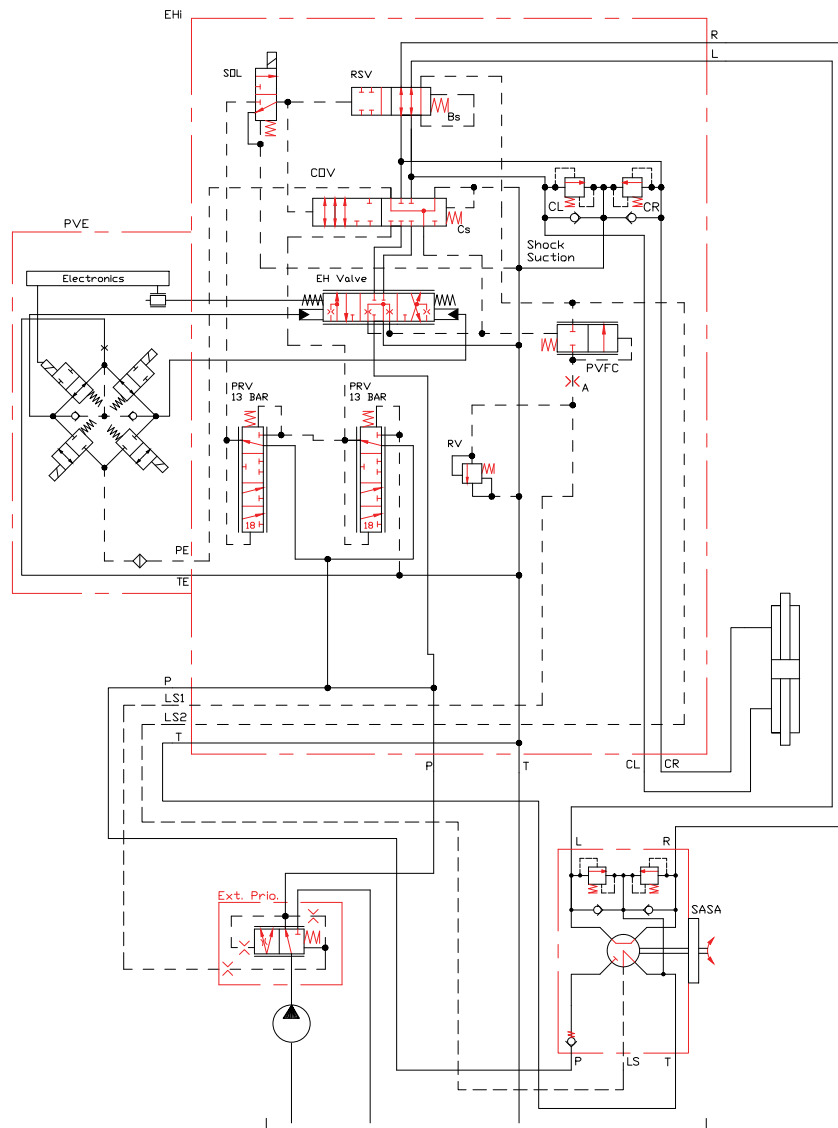

**Versions**

**EHi for Steer by Wire steering system**

**EHi xx W1 N**

This version is to be used in a fail-safe Steer by Wire steering system. Only the EHi valve can control the steering cylinder. Priority valve is needed inside EHi steering valve to generate stand by pressure across the directional spool. Engage and disengage of the EH steering can be controlled by a PVED-CLS actuator or by a vehicle controller. EH steering will be disabled, when the electric power is shut down for the solenoid valve (SOL).

**Configuration number: EHi-7**

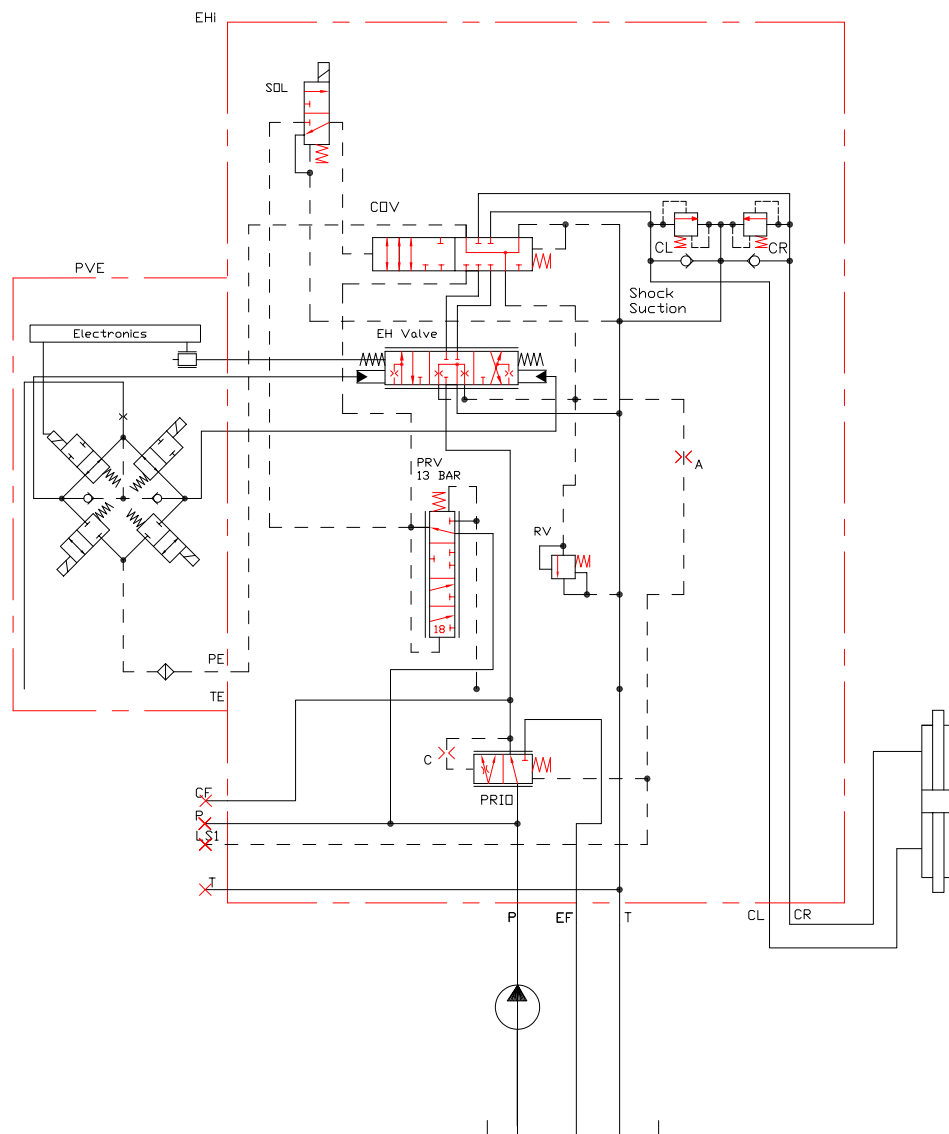

**Versions**

**EHi for Hydraulic Disengage**

***EHi xx xx x H***

The hydraulic disengage versions of EHi for Load Sensing (EHi-9) and Open Center (EHi-10) are designed for use with either Reaction or Non-Reaction steering units. A load sense signal is used to disengage EH steering, so the SASA sensor is not required. EH steering will be disabled when the electrical power is shut down for the solenoid valve (SOL).

***Configuration number: EHi-9***

*Example shown is for load sensing dynamic*

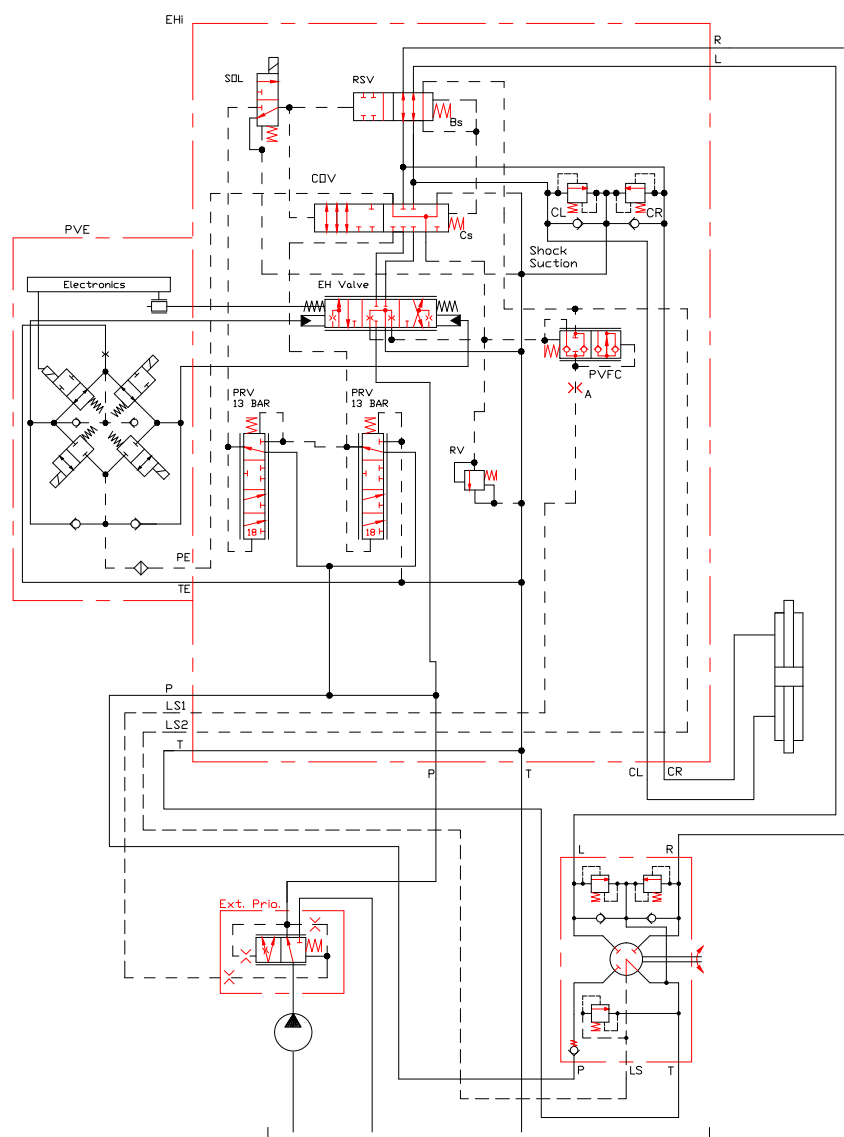

**Versions**

**Configuration number: EHi-10**

For Open-Center

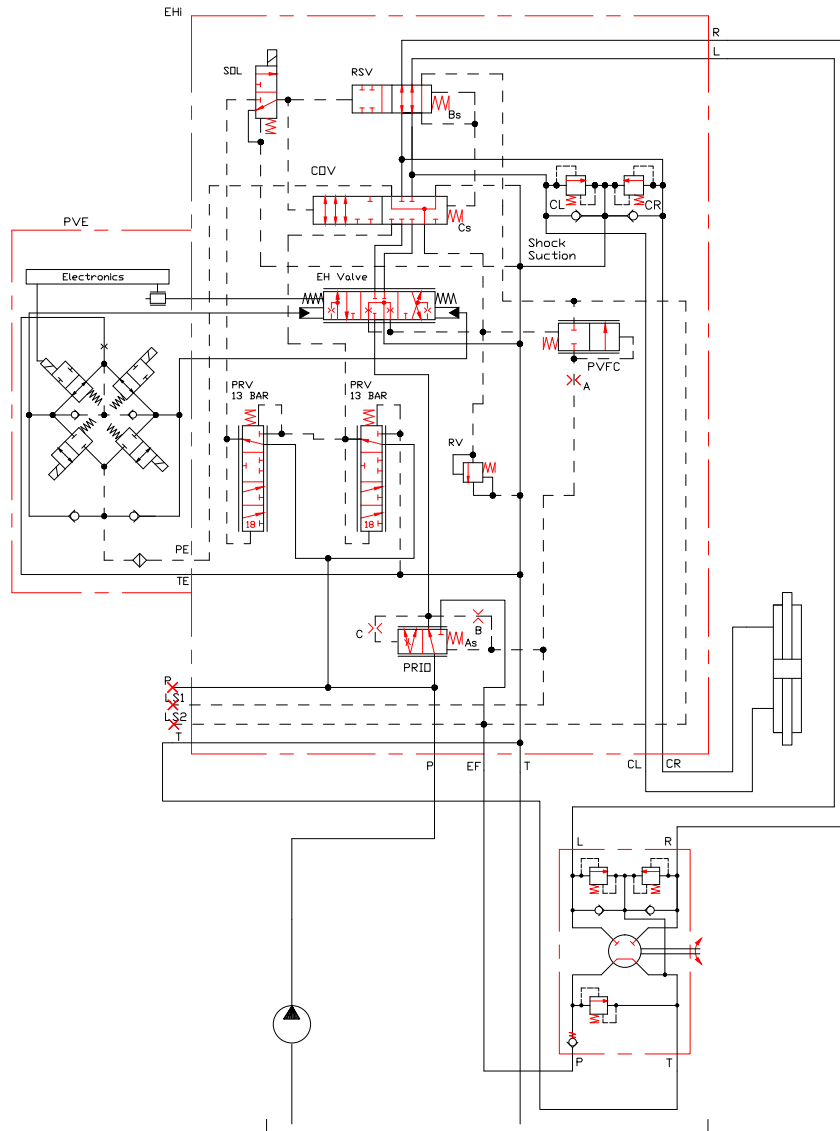



**Function**

**Main components**

*The EHi Steering Valve main components*

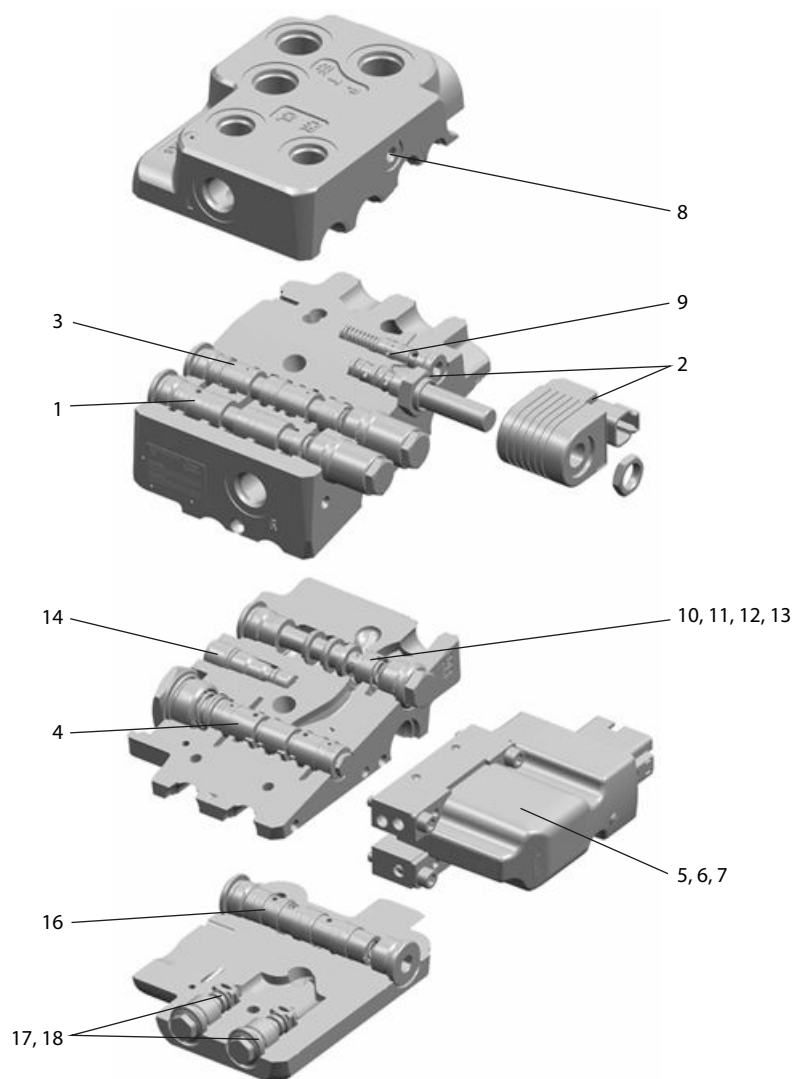

1.	RSV: Reaction Switch Valve	10.	PP damping orifice
2.	SOL: Solenoid control valve for EH cut off valve and RSV	11.	Priority valve spool
3.	COV: EH cut off valve	12.	Priority valve spring
4.	EH directional valve	13.	Dynamic orifice
5.	PVE control unit	14.	Pilot pressure relief valve
6.	Spool position sensor LVDT	15.	LS orifice (not shown in image)
7.	Solenoid valve bridge	16.	PVFC valve/LS resolver
8.	Pilot reduction valve, 13 bar, SOL-PE	17.	Suction valves
9.	Pilot reduction valve, 13 bar, PE-T	18.	Shock valves

**Function**

**EHi xx LD R E for Reaction type steering unit**

EHi for Load Sensing Dynamic Reaction OSP Steering unit, electrical disengage of EHi by SASA steering wheel sensor.

Configuration number: EHi-5

**Neutral position**

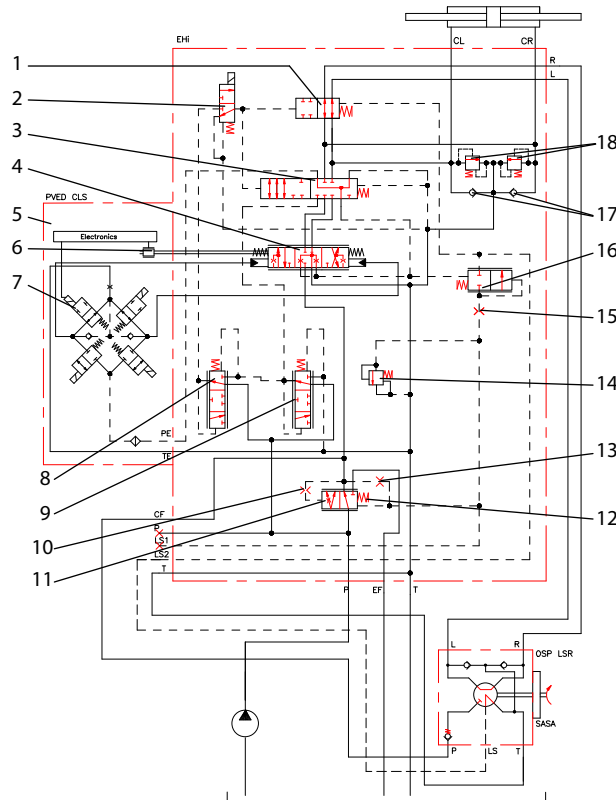

1.	RSV: Reaction Switch Valve	10.	PP damping orifice
2.	SOL: Solenoid control valve for EH cut off valve and RSV	11.	Priority valve spool
3.	COV: EH cut off valve	12.	Priority valve spring
4.	EH directional valve	13.	Dynamic orifice
5.	PVE control unit	14.	Pilot pressure relief valve
6.	Spool position sensor LVDT	15.	LS orifice
7.	Solenoid valve bridge	16.	PVFC valve/LS resolver
8.	Pilot reduction valve, 13 bar, SOL-PE	17.	Suction valves
9.	Pilot reduction valve, 13 bar, PE-T	18.	Shock valves

When the engine is turned off, the priority valve spool (11) is pushed to the left by the priority valve spring (12). The passage to the EF port is blocked. The passage to the EH directional valve spool (4) and to the CF port of EHi is open. The P-port of the OSP LSR steering unit is connected to CF port of EHi.

When the engine is on and the steering unit OSP and the EH directional valve (4) is in neutral position, the CF pressure will rise to match the spring force in the priority valve, consequently the priority valve spool (11) will move to the right and the main pump flow will pass from P port of EHi across the integrated priority valve spool (11) and out through the EF port. The priority valve is a "dynamic" type, meaning, when pump is on, a minor oil flow passes from CF through the Dynamic orifice (13) integrated in priority

## Function

valve spool (11), the LS orifice (15), the PVFC valve/LS resolver (16), out of LS2 port of EHi and into the LS port of the OSP steering unit. In OSP the flow in LS line streams into the spool/sleeve set and in neutral position this dynamic oil flow passes on to tank.

When the OSP LSR reaction type steering unit is in neutral position and the solenoid control valve (2) is deactivated, then the steering system has Reaction features: the RSV valve (1) makes connection between the cylinder ports, CL and CR, through L and R of OSP. If the steering wheel is untouched and a delta P is generated in the steering cylinder, e.g. from self-aligning of the steered front axle, oil will pass from L to R or R to L through the spool/sleeve set and gear set of the OSP steering unit and the steering wheel will rotate until it is grabbed or delta P disappears. Only the force of the neutral spring package inside the OSP has to be overcome to stop to rotation of the steering wheel and so stop the cylinder movement/reaction feature.

When the SOL: Solenoid control valve for EH cut off valve (2) is deactivated, the COV: EH cut off valve (3) will prevent unintended EH steering, because CL and CR connections from EH directional valve (4) are blocked in COV: EH cut off valve (3). Pilot pressure to the PVE solenoid valve bridge (7) is interrupted. OSP steering is possible, due to RSV: Reaction Switch Valve (1) stays in normal open position.

---

For any steering system that includes a steering unit OSP and EHi valve with Reaction Switch Valve (RSV), it is important that EHi and OSP share the same tank pressure. For this purpose, the EHi provides two tank ports, one of which is intended for connection to the OSP steering unit.

---

### **Caution**

---

Loss of EH steering or for reaction systems, an unintended turning of the steering wheel. In load sense systems, the LS to T pressure, and in open center systems the P to T pressure drop in the steering unit should not exceed 14 bar when the steering unit is in neutral position.

---

**Function**

**Steering Right with EHi**

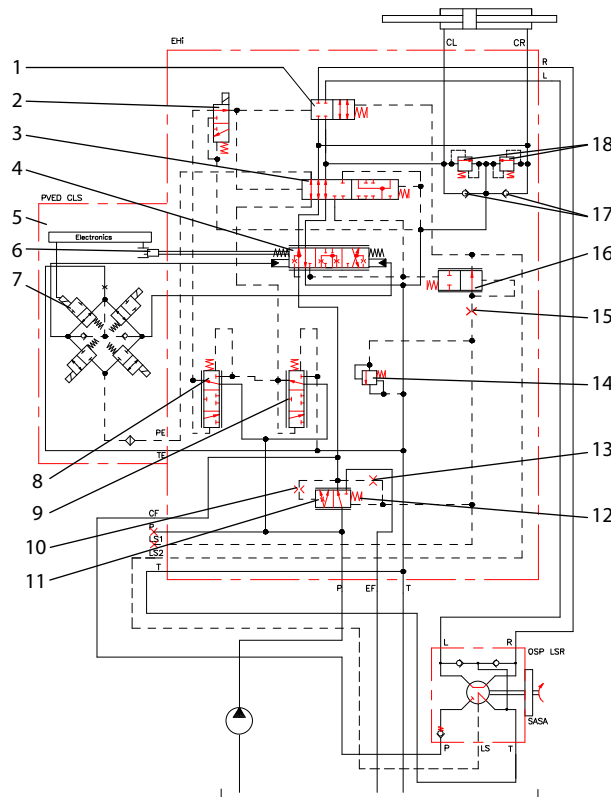

1.	RSV: Reaction Switch Valve	10.	PP damping orifice
2.	SOL: Solenoid control valve for EH cut off valve and RSV	11.	Priority valve spool
3.	COV: EH cut off valve	12.	Priority valve spring
4.	EH directional valve	13.	Dynamic orifice
5.	PVE control unit	14.	Pilot pressure relief valve
6.	Spool position sensor LVDT	15.	LS orifice
7.	Solenoid valve bridge	16.	PVFC valve/LS resolver
8.	Pilot reduction valve, 13 bar, SOL-PE	17.	Suction valves
9.	Pilot reduction valve, 13 bar, PE-T	18.	Shock valves

This EHi valve has two pilot reduction valves, PRV's: (8) and (9):

- PRV (9) gives pilot supply, 13 bar above tank pressure to the PVE (5), when the EH cut off valve, COV (3) is activated.
- PRV (8) gives pilot pressure, up to 13 bar above PVE pilot pressure (in total up to 26 bar above tank pressure) to activate the reaction switch valve, RSV (1), and to activate COV (3), when the solenoid valve SOL (2) is activated.

Before it is possible to steer with the EHi valve, it is needed to power the solenoid valve (2). When having PVED-CLS (5) on the EHi, the CLS controls the SOL (2). The CLS must receive an input from a MMI (Man Machine Interface) to provide EH steering and the CLS will power the SOL (2).

When RSV (1) is activated, Reaction feature of the LSR type steering unit is blocked, the steering wheel will stay in fixed position independent of cylinder port pressures.

## Function

When an input signal for steering is transmitted to the electrical connectors of the PVE (5), in this example to steer to the right, the solenoid valve bridge (7) is activated, and the EH directional spool (4) is moved to the right. So LS in spool (4) will sense the needed steering pressure, and this is transmitted to the PVFC valve/LS resolver (16). So the valve (16) makes restriction in the dynamic LS flow from dynamic orifice (13) of priority valve, and the LS pressure on the priority valve spool (11) will match the LS pressure required from the EH directional valve spool (4). Accordingly, the position of the priority valve spool (11) will change to match the flow and pressure demand for EH-steering.

In case the monitoring part of the PVED-CLS registers an unintended EH directional spool movement, the electrical power to the SOL (2) will be switched off.

The valves (8 and 9) will dump pilot pressure to tank, COV (3) will change position so that connection from EH directional valve spool (4) to cylinder ports will be blocked. Furthermore, it will not be possible to activate the solenoid valve bridge (7) of PVE without pilot pressure. RSV (1) also changes position to open connection between L and R of OSP to the cylinder ports CL and CR.

In any steering scenario, manual steering wheel steering can override the EH steering by turning the steering wheel; the steering wheel sensor type SASA transmits signal to the PVED-CLS and the EH steering will disengage to give steering wheel priority. Furthermore, LS pressure from OSP steering unit will increase, and this pressure will be transmitted to port LS2 of EHi and on to the RSV (1) and this will open for steering wheel steering. For hydraulic disengage versions, the PVED-CLS detects an inability to move the EH directional valve due to the same LS pressure increase from the OSP also acting on the COV and creating a PVE pilot pressure (PE) drain to tank through the COV.

### Function

#### Steering Right with EHi and OSP: variable steer mode

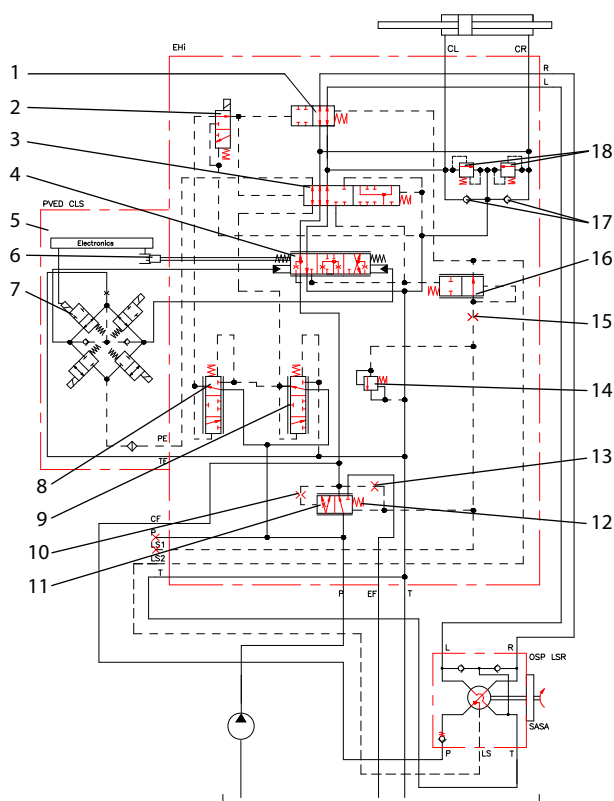

1.	RSV: Reaction Switch Valve	10.	PP damping orifice
2.	SOL: Solenoid control valve for EH cut off valve and RSV	11.	Priority valve spool
3.	COV: EH cut off valve	12.	Priority valve spring
4.	EH directional valve	13.	Dynamic orifice
5.	PVE control unit	14.	Pilot pressure relief valve
6.	Spool position sensor LVDT	15.	LS orifice
7.	Solenoid valve bridge	16.	PVFC valve/LS resolver
8.	Pilot reduction valve, 13 bar, SOL-PE	17.	Suction valves
9.	Pilot reduction valve, 13 bar, PE-T	18.	Shock valves

For this variable steering ratio/combined steering mode: EHi + OSP, the CLS must receive an input from a MMI (Man Machine Interface) to allow EH and OSP steering in combination: The SASA signal will be used to add EH flow to the OSP steering as function of steering wheel speed. The LS pressure from OSP will be transmitted to the LS2 port of the EHi, and on to the RSV (1), so that this will stay in open position during steering wheel steering. At the same time the PVED CLS (5) will receive a signal to add EH flow to the OSP flow. So the number of turns on the steering wheel moving the steered wheels from the one to the other lock will be reduced dependent on parameter setting of the PVED CLS.

## Function

### EHi xx LD N E for Non-Reaction type steering unit

EHi for Load Sensing Dynamic none reaction OSP Steering unit, electrical disengage of EHi by SASA Steering Wheel Sensor. This EHi version has less valve functions than EHi for Reaction type steering unit, described [EHi xx LD R E for Reaction type steering unit](#) on page 18. When the none reaction type steering unit has integrated shock and suction valves, these valve functions are not needed inside the EHi valve. With no reaction switch valve (RSV) it is not needed to have high pilot pressure, therefore only one pilot reduction valve is present.

Configuration number: EHi-4

### Neutral position

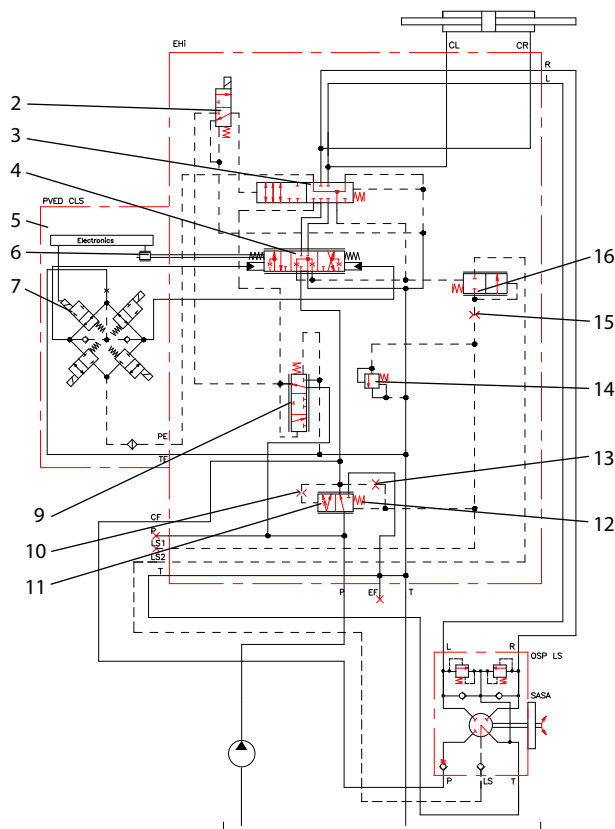

2.	SOL: Solenoid control valve for EH cut off valve	10.	PP damping orifice
3.	COV: EH cut off valve	11.	Priority valve spool
4.	EH directional valve	12.	Priority valve spring
5.	PVE control unit	13.	Dynamic orifice
6.	Spool position sensor LVDT	14.	Pilot pressure relief valve
7.	Solenoid valve bridge	15.	LS orifice
9.	Pilot reduction valve, 13 bar, PE-T	16.	PVFC valve/LS resolver

When the engine is turned off, the priority valve spool (11) is pushed to the left by the spring (12). The passage to the EF port is blocked. The passage to the EH directional valve spool (4) and to the CF port of EHi is open. The P-port of the OSP LS steering unit is connected to CF port of EHi.

When the engine is on and the steering unit OSP and the EH spool (4) is in neutral position, the CF pressure will rise to match the spring force in the priority valve, consequently the priority valve spool (11)

**Function**

will move to the right and the main pump flow will pass from P port of EHi across the integrated priority valve spool (11) and out through the EF port.

The priority valve is a “dynamic” type, meaning, when pump is on, a minor oil flow passes from CF through the Dynamic orifice (13) (integrated in spool 11), the LS orifice (15), the PVFC valve (16), out of LS2 port of EHi and into the LS port of the OSP steering unit. In OSP the flow in LS line streams across the LS check valve and into the spool/sleeve set and in neutral position this dynamic oil flow passes on to tank.

When the solenoid control valve (2) is deactivated, the EH cut off valve (3) makes unintended EH steering impossible, if for example, a false input signal comes to the PVE control unit (5), because CL and CR connections from EH directional valve spool (4) are blocked in (3).

**Steering Right with EHi**

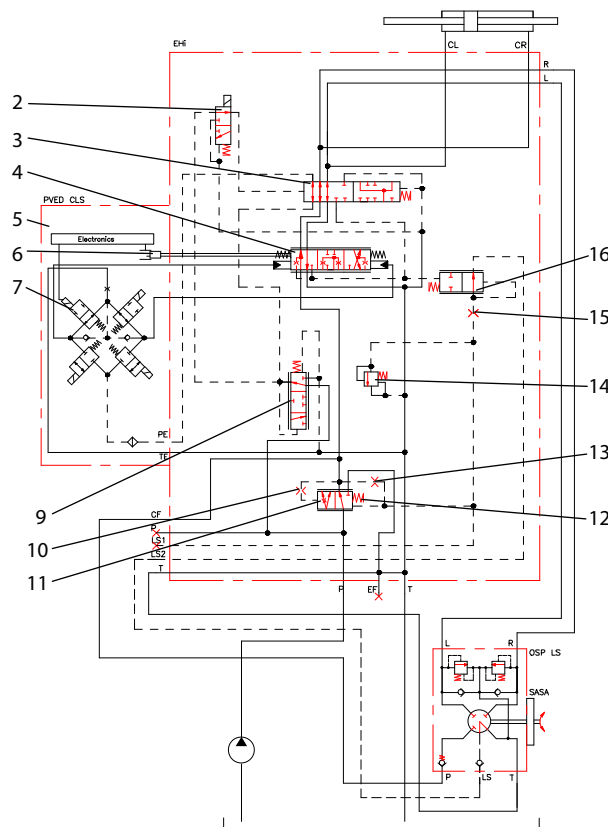

2.	SOL: Solenoid control valve for EH cut off valve	10.	PP damping orifice
3.	COV: EH cut off valve	11.	Priority valve spool
4.	EH directional valve	12.	Priority valve spring
5.	PVE control unit	13.	Dynamic orifice
6.	Spool position sensor LVDT	14.	Pilot pressure relief valve
7.	Solenoid valve bridge	15.	LS orifice
9.	Pilot reduction valve, 13 bar, PE-T	16.	PVFC valve/LS resolver

Before it is possible to steer with the EHi valve, it is needed to power the solenoid valve, SOL (2). When having PVED CLS (5) on the EHi, the CLS controls the SOL (2). The CLS must receive an input from a MMI (Man Machine Interface) to provide EH steering and the CLS will power the SOL (2). When SOL is



## Function

activated, the EH cut off valve, COV (3) will be moved and pilot pressure from pilot reduction valve, PRV (9) gives pilot supply to the PVE (5) and COV opens for EH steering.

When an input signal for steering is transmitted to the electrical connectors of the PVE (5), in this example to steer to the right, the solenoid valve bridge (7) is activated, and the EH directional spool (4) is moved to the right. So LS in spool (4) will sense the needed steering pressure, and this is transmitted to the PVFC valve/LS resolver (16). So the valve (16) makes restriction in the dynamic LS flow from dynamic orifice (13) of priority valve, and the LS pressure on the priority valve spool (11) will match the LS pressure required from the EH directional valve spool (4). Accordingly, the position of the priority valve spool (11) will change to match the flow and pressure demand for EH-steering.

In case the monitoring part of the PVED CLS registers an unintended EH directional spool movement, the electrical power to the SOL (2) will be switched off. So valve (9) will dump pilot pressure to tank, COV (3) will change position, then connection from EH directional valve spool (4) to cylinder ports will be blocked, and EH steering stops.

In any steering scenario, manual steering wheel steering can override the EH steering: by turning the steering wheel, the steering wheel sensor type SASA transmits signal to the PVED CLS and the EH steering will disengage to give steering wheel priority.

Variable steering ratio/Combined steering mode, EHi + OSP is also possible (not illustrated as diagram): The CLS must receive an input from a MMI (Man Machine Interface) to allow EH and OSP steering in combination: The SASA signal will be used to add EH flow to the OSP steering as function of steering wheel speed. So the number of turns on the steering wheel moving the steered wheels from the one to the other lock will be reduced dependent on parameter setting of the PVED CLS.

**Function**

**EHi xx W1 N for Steer by Wire steering**

EHi Load Sensing Static steering valve for fail-safe Steer by wire Steering. EHi only can be disengaged by removing electric power to solenoid valve.

Configuration number: EHi-7

**Neutral position**

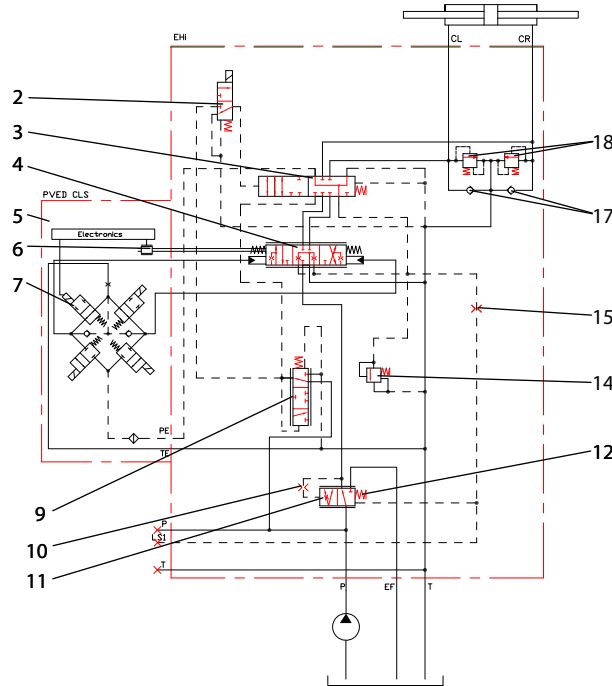

2.	SOL: Solenoid control valve for EH cut off valve	10.	PP damping orifice
3.	COV: EH cut off valve	11.	Priority valve spool
4.	EH directional valve	12.	Priority valve spring
5.	PVE control unit	14.	Pilot pressure relief valve
6.	Spool position sensor LVDT	15.	LS orifice
7.	Solenoid valve bridge	17.	Suction valve
9.	Pilot reduction valve, 13 bar, PE-T	18.	Shock valves

When the engine is turned off, the priority valve spool (11) is pushed to the left by the spring (12). The passage to the EF port is blocked. The passage to the EH directional valve spool (4) is open. When the engine is on and the EH spool (4) is in neutral position, the CF pressure will rise to match the spring force in the priority valve, consequently the priority valve spool (11) will move to the right and the main pump flow will pass from P port of EHi across the integrated priority valve spool (11) and out through the EF port.

When the solenoid control valve (2) is deactivated, the EH cut off valve (3) will prevent unintended EH steering, because CL and CR connections from EH directional valve spool (4) are blocked in (3). Pilot pressure to the PVE solenoid valve bridge (7) is interrupted.

**Function**

**Steering Right with EHi**

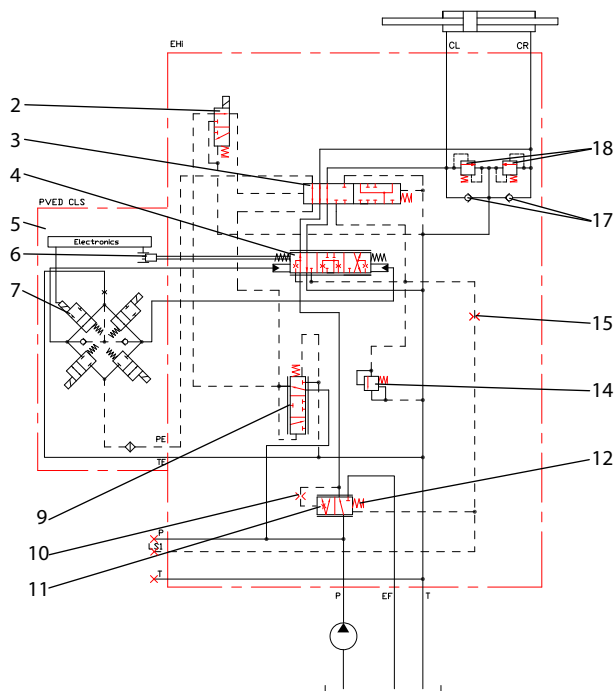

2.	SOL: Solenoid control valve for EH cut off valve	10.	PP damping orifice
3.	COV: EH cut off valve	11.	Priority valve spool
4.	EH directional valve	12.	Priority valve spring
5.	PVE control unit	14.	Pilot pressure relief valve
6.	Spool position sensor LVDT	15.	LS orifice
7.	Solenoid valve bridge	17.	Suction valve
9.	Pilot reduction valve, 13 bar, PE-T	18.	Shock valves

Before it is possible to steer with the EHi valve, it is needed to power the solenoid valve, SOL (2). When having PVED-CLS (5) on the EHi, the CLS controls the SOL (2). The CLS must receive an input from a MMI (Man Machine Interface) to provide EH steering and the CLS will power the SOL (2). When SOL is activated, the EH cut off valve, COV (3) will be moved and pilot pressure from pilot reduction valve, PRV (9) gives pilot supply to the PVE (5) and COV opens for EH steering. When an input signal for steering is transmitted to the electrical connectors of the PVE (5), in this example to steer to the right, the solenoid valve bridge (7) is activated, and the EH directional spool (4) is moved to the right. So LS in spool (4) will sense the needed steering pressure, and this is transmitted on to the priority valve spool (11). Accordingly, the position of the priority valve spool (11) will change to match the flow and pressure demand for EH-steering.

In case the monitoring part of the PVED-CLS registers an unintended EH directional spool movement, the electrical power to the SOL (2) will be switched off. So valve (9) will dump pilot pressure to tank, COV (3) will change position, then connection from EH directional valve spool (4) to cylinder ports will be blocked, and EH steering stops.

## Technical data

### EHi

The technical data for EHi are typical measured results. For the hydraulic system a mineral based hydraulic oil with a viscosity of 21 mm<sup>2</sup>/s (102 SUS) and a temperature of 50° C (122° F) was used.

Max. pressure	Port P-T, EF-T	250 bar	[3625 psi]
	Port CF-T	250 bar	[3625 psi]
	Port LS1-T, LS2-T	250 bar	[3625 psi]
	Port L-T, R-T, CL-T, CR-T	308 bar	[4467 psi]
	Port T	25 bar	[362 psi]
Oil flow rated	Port P, EF	90 l/min	[23.8 US gal/min]
	Port L, R, CL, CR steering wheel steering	70 l/min	[18.5 US gal/min]
	Port CL, CR EH steering	12, 20, 30, 40, 50 or 70 l/min	[3.2, 5.3, 7.9, 10.6, 13.2 or 18.5 US gal/min]
Spool travel, EH directional spool		± 4 mm	[± 0.16 in]
Dead band, EH-directional spool, nominal		± 0.8 mm	[± 0.03 in]
Priority valve	Type	Dynamic or Static	
	Spring force	7 bar, 10 bar	[100 psi, 145 psi]
	Nominal flow	45 or 90 l/min	11.9 or [23.8 US gal/min]
Oil temperature	Recommended temperature	+30° C to +60° C	[+86° F to +140° F]
	Min. temperature	-30° C	[-22° F]
	Max. temperature	90° C	[190° F]
Ambient temperature		-30° C to +60° C	[+22° F to +140° F]
Oil viscosity	Operating range	12 to 75 mm <sup>2</sup> /sec	[66.0 to 370.3 SUS]
	Min. viscosity	10 mm <sup>2</sup> /sec	[58.9 SUS]
	Max. viscosity	460 mm <sup>2</sup> /sec	[2134 SUS]
Filtration	Max contamination (ISO 4406)	21/19/16	
Temperature difference between steering valve and other hydraulics	Max.	Δ10° C	[Δ18° F]

### Weight

EHi weighs 11.2 kg (24.7 lbs).

### PVE actuation modules

*PVE actuation modules comprehensive technical literature*

<b>PVED-CLS</b>	<i>OSPE with PVED-CLS Steering Valve Controller Data Sheet</i>	<b>A1152986484866</b>
<b>PVED-CC Series 5</b>	<i>PVED-CC Series 5 Technical Information</i>	<b>BC159886484234</b>
<b>PVES Series 7</b>	<i>PVE Series 7 Technical Information</i>	<b>BC218286485446</b>

Comprehensive technical literature is online at [www.danfoss.com](http://www.danfoss.com)

## Technical data

### PVE actuation modules main values

		PVED-CLS	PVED-CC	PVES
Supply voltage		9 to 35 Vdc		11 to 32 Vdc
Current consumption	in operational/off-road mode, activating cut off valve, max	1.32 A at 12 V	-	-
	in on-road mode	0.23 A at 12 V	-	-
	in operational mode	-	0.52 A at 12 V	-
	in neutral – Power state	-	0.08 A at 12 V	-
	at rated voltage PVES	-	-	0.57 A at 12 V
Signal voltage	neutral	-	-	0.5 x U DC
	CR-port ↔ CL-port	-	-	0.25 · U DC to 0.75 · U DC
Signal current at rated voltage		-	-	0.25 mA to 0.70 mA
Oil consumption	Electrical de-energized	0 l/min	0 l/min	0.3 l/min
	Spool locked position	0 l/min	0 l/min	0.1 l/min
	Pilot oil flow, continuous actuations	0.7 l/min	0.7 l/min	0.8 l/min
Oil viscosity	range	12 to 75 mm <sup>2</sup> /s		
	min.	10 mm <sup>2</sup> /s		
	max.	460 mm <sup>2</sup> /s		
Oil temperature	Rec. range	+30° C to +60° C (+86° F to +140° F)		
	min.	-30° C (+22° F)		
	max.	90° C (194° F)		
Ambient temperature	Rec. range	-30° C to +60° C (+22° F to +140° F)		
Filtering		Max. allowed degree of contamination (ISO 4406): 23/19/16		
Pilot pressure	Rec. range	13.5 ± 1.5 bar		
Hysteresis		approx. 0%		
Enclosure	DEUTSCH connector	IP 67		
Pins, surface treatment	DEUTSCH connector	Sn/Tin		Ni/Nickel

**Technical data**

**PVE connectors**

**PVED-CLS**

*DEUTSCH one 12 pin connector - DT04-12PA-B016*

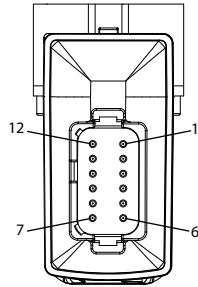

*Pinouts*

Pinout	Function	Pinout	Function
1	AD2	7	Power ground -
2	AD3	8	Power supply +
3	Sensor power ground	9	CAN_L_MAIN
4	CAN_H_SAFETY	10	CAN_H_MAIN
5	CAN_L_SAFETY	11	5V sensor supply+
6	Digital output	12	AD1

Terminator resistor: None

Mating connector: DT06-12SA-P012

**PVED-CC**

*DEUTSCH DT - two 4 pin connector, DT04-4P*

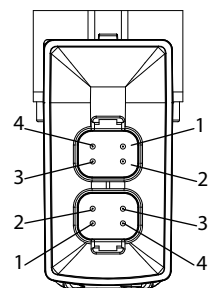

*Pinouts*

Pinout	Function	Pinout	Function
<b>Front</b>		<b>Back</b>	
1	CAN_H	1	CAN_H
2	CAN_L	2	CAN_L
3	Power supply +	3	Power supply +
4	Power ground -	4	Power ground -

Terminator resistor: None

Mating connector: DT06-4S-E003

**Technical data**

**PVES**

*DEUTSCH DT - one 6 pin connector, DT04-6P*

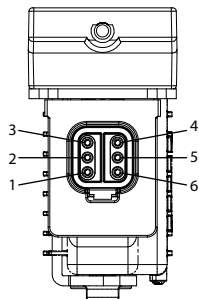

*Pinouts*

Pinout	Function	Pinout	Function
1	Vsignal	4	Spool position
2	Error	5	Power ground -
3	Not used	6	Power ground +

Mating connector: DT06-6S-E003

**Technical data**

**Coil of control valve for mode select**

**Specifications**

- Duty cycle rating: 100%
- Magnet wire insulation: Class H (180C)
- Ambient temperature: -30° C to +60° C [-22° F to +140° F]
- Diodes are available; contact your Danfoss representative
- Environmental protection: IP 65
- All AC coils are internally rectified

*Operating limits, D08, 16 watt coil*

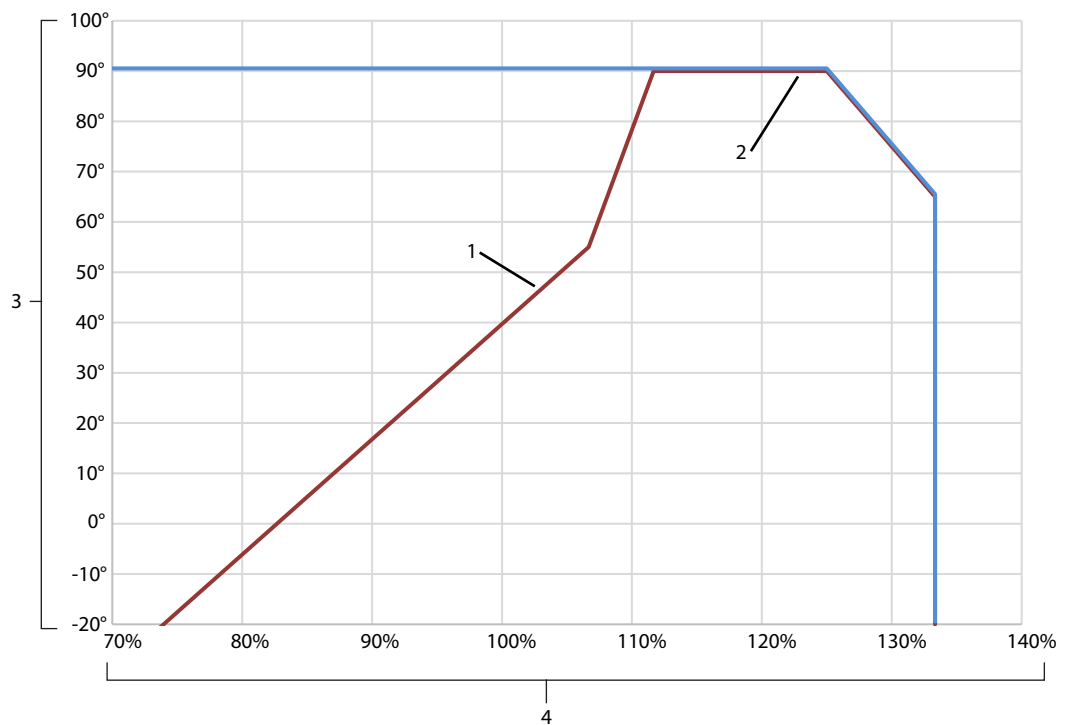

1. Minimum pull-in voltage
2. Maximum operating limit
3. Ambient temperature in Celsius
4. Percent rated voltage

**Electrical specifications**

*16 watt coils*

Voltage (V)	Resistance (Ohms) ±5% at 20° C [72 °F]	Current draw (A) at 25° C [77° F]	Color	Terminals
12	9	1.33	Gray	DEUTSCH
24	36	0.67	Black	DEUTSCH



**Technical data**

**Terminals**

*DEUTSCH Code DE*

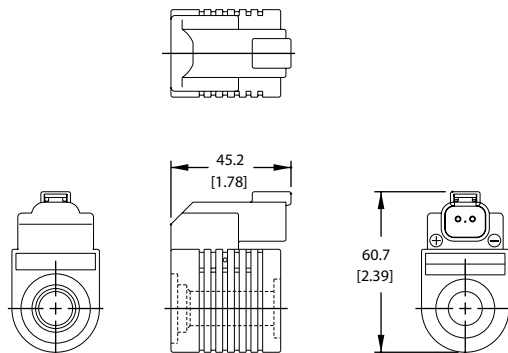

Voltage (V)	Power (W)	Part number
12	16	D08-16-12D-DE
24	16	D08-16-24D-DE

## Dimensioning steering system

### Steering systems with EHi steering valve

Steering systems using an ordinary steering unit (for example, Danfoss OSP type steering unit), for manual steering and an EHi valve for electrical steering (for example, auto guidance, joystick, and/or variable steering), the following main values for EHi must be decided.

- Nominal cylinder port flow, CQ
  - Normally based on port flow available from OSP approximately at 100 rpm steering wheel speed, for example, an OSPC 200, the port flow will be 20 l/min at 100 rpm, so the EH directional spool should be the one with CQ = 20 l/min nominal.
- Maximum steering pressure, bar, P-T
  - Same as the P-T value for the OSP steering unit if a relief valve is present in the OSP, otherwise P-T setting of the EHi must be determined based on maximum steering system pressure allowed.
- Shock valves, whether needed or not
  - If shock valves outside the EHi valve are protecting the cylinder ports of the EHi in any steering mode, no shock valves will be needed inside the EHi valve.
  - If shock valves are needed inside EHi, the setting must be approximately 50 bar higher than maximum steering pressure, P-T.

**! Caution**

High steering cylinder speed can affect controllability of the vehicle.

Do not choose a directional spool with higher nominal flow than recommended, which can affect requirements for response time of any safety functions added to the steering system.

---

**! Caution**

EHi, in connection with OSPD ON/OR, Open center type steering units with dual displacement, system instability can be an issue.

Minimum flow of 5 l/min to the P port of the steering unit must be ensured, so that in any EH steering situation, shift valve in the OSPD steering unit will be in position for normal steer mode/full displacement. Flow to P port of OSPD should not drop below 5 l/min to avoid the shift valve moving to "emergency steer position".

---

For fail-safe Steer By Wire Steering systems only using EHi valve for the following main values for EHi must be decided.

- Nominal cylinder port flow, CQ
  - Normally based on maximum time(s) for turning steered wheels from one to the other cylinder lock, cylinder having stroke volume V
 
$$V(l) 0,800 l$$

$$t(s) 2,4 \text{ sec}$$

$$=>$$

$$CQ (l/min) = V/t = (0,8/2,4)*60 = 20 l/min$$
- Maximum steering pressure, bar, P-T
  - Must be determined based on maximum steering system pressure allowed.
- Shock valve setting
  - Must be approximately 50 bar higher than maximum steering pressure, P-T

For other options to be determined for EHi, see [Versions](#) on page 7.

## Technical characteristics

### EH-directional spools of EHi

Cylinder flow characteristic for directional spools

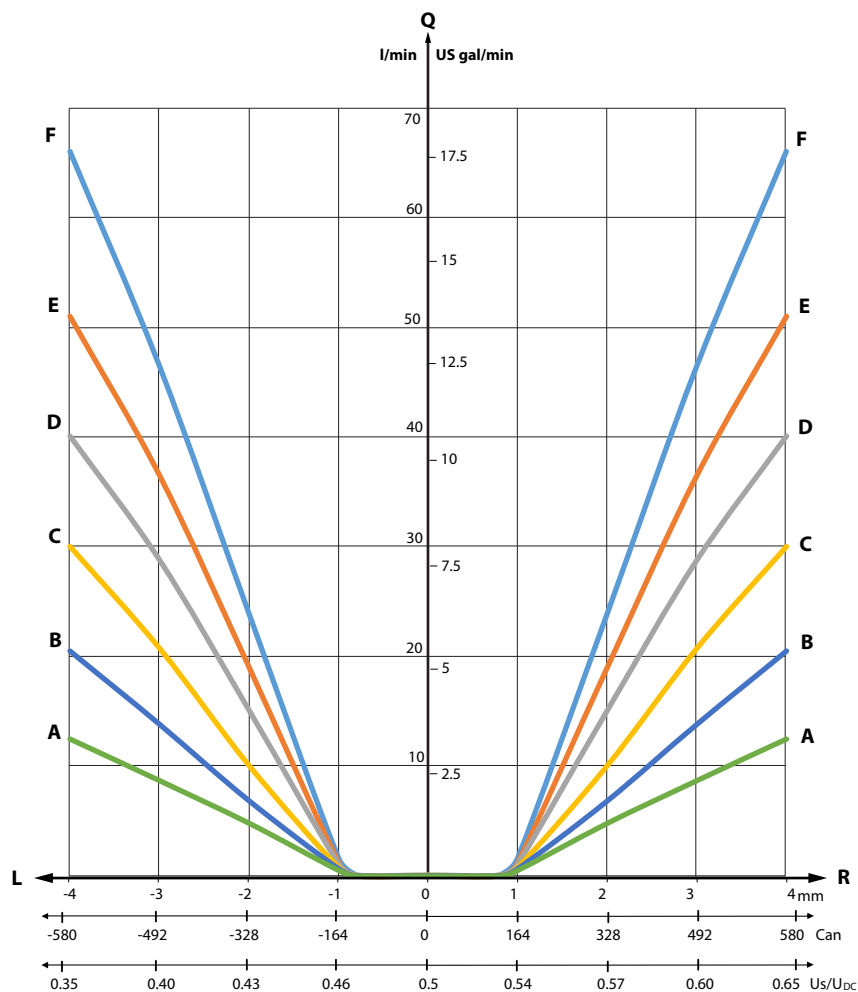

- A** = Valid for spools for nominal cylinder flow  $CQ = 12$  l/min [3.17 US gal/min]
- B** = Valid for spools for nominal cylinder flow  $CQ = 20$  l/min [5.28 US gal/min]
- C** = Valid for spools for nominal cylinder flow  $CQ = 30$  l/min [7.97 US gal/min]
- D** = Valid for spools for nominal cylinder flow  $CQ = 40$  l/min [10.57 US gal/min]
- E** = Valid for spools for nominal cylinder flow  $CQ = 50$  l/min [13.21 US gal/min]
- F** = Valid for spools for nominal cylinder flow  $CQ = 70$  l/min [18.48 US gal/min]

The curves, A through E, are valid for EHi with internal priority valve with 7 bar [100 psi] spring and 0.9 mm [0.035 in] dynamic orifice, and 1.2 mm (0.047 in) LS orifice, and at 60 l/min [15.85 US gal/min] pump flow.

For EHi without internal priority valve, the curves, A through E, are valid in combination with external priority valve OLS 80, 152B8258 at 60 l/min [15.85 US gal/min] pump flow.

The curve F is valid for EHi with internal priority valve with 10 bar [145 psi] spring and 0.9 mm [0.034 in] dynamic orifice and 1.2 mm (0.047 in) LS orifice and at 100 l/min [26.41 US gal/min] pump flow.

**Technical characteristics**

For EHi without internal priority valve, the curves, F is valid in combination with external priority valve OLS 120, 152B8129 at 100 l/min [26.41 US gal/min] pump flow.

**Pilot pressure relief valve, (P - T, Qp) characteristic**

The pilot pressure relief valve protects the steering system against excessive pressure.

The pilot pressure relief valve works together with the priority valve in the EHi or together with the external priority valve to limit the maximum steering pressure P-T. The pilot pressure relief valve is set at an oil flow to the priority valve of 25 l/min [6.6 US gal/min].

Setting tolerance: rated value +10 bar [145 psi].

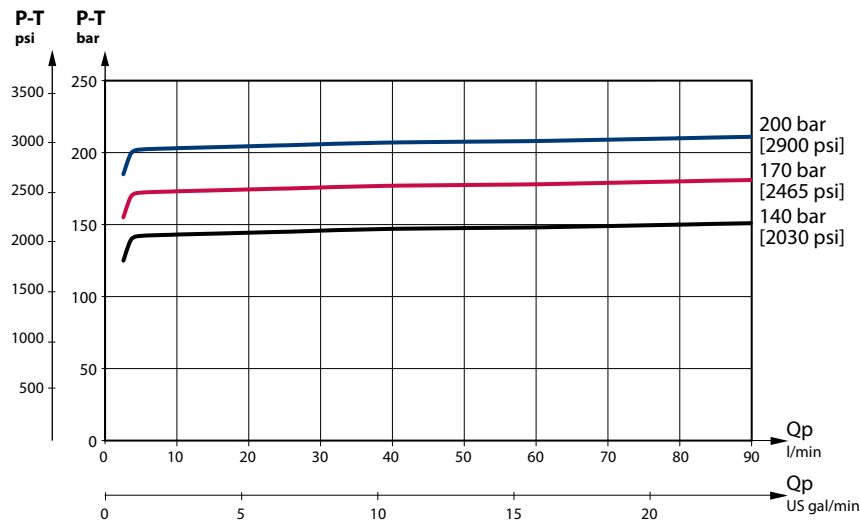

EHi's with 45 l/min priority valve spool should not be applied with more than 45 l/min pump flow.

**Pressure drop, P-EF for EHi valve**

This data comes from measurements on a representative sample of EHi valves from production. Oil with viscosity of 21 mm<sup>2</sup>/s at 50° C was used during measuring.

Measurement is made when the pressure on the LS connection is zero. The minimum curve applies when the pressure on the EF connection is higher than the actual control spring pressure.

The curve for control spring pressure of 7 bar [100 psi] and 10 bar [145 psi] applies when pressure on the EF port is zero.

Technical characteristics

EHi with 45 l/min priority valve spool

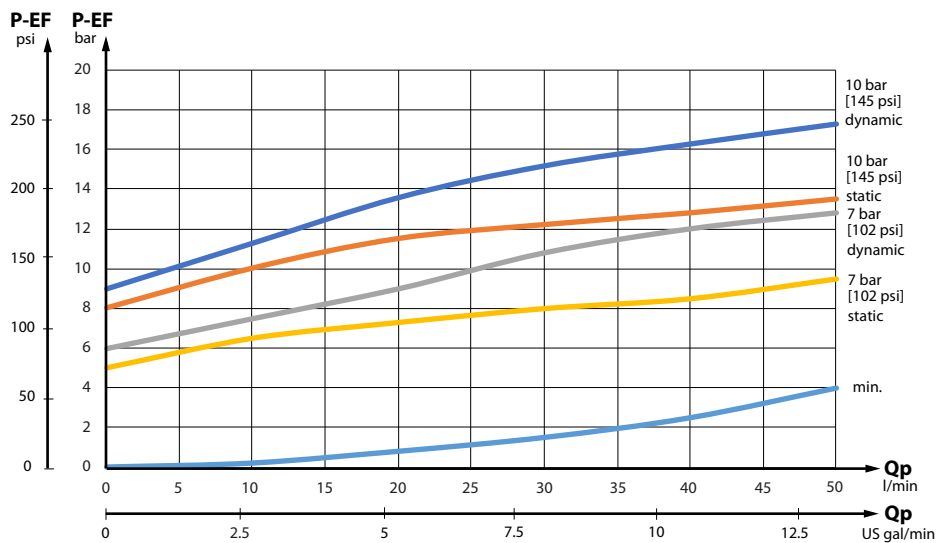

EHi with 90 l/min priority valve spool

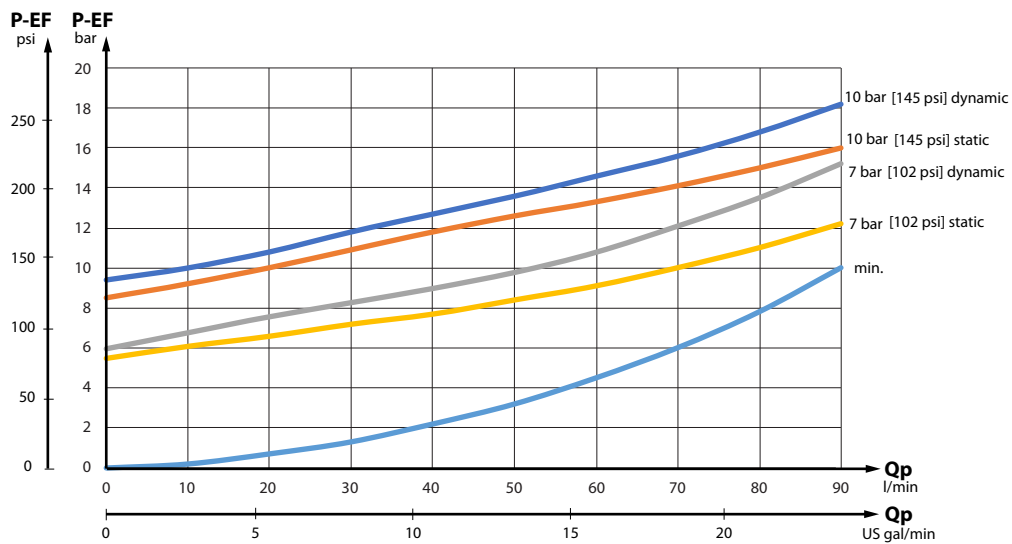

**Dimensions**

**EHi with PVED-CLS**

*Dimensions in millimeters*

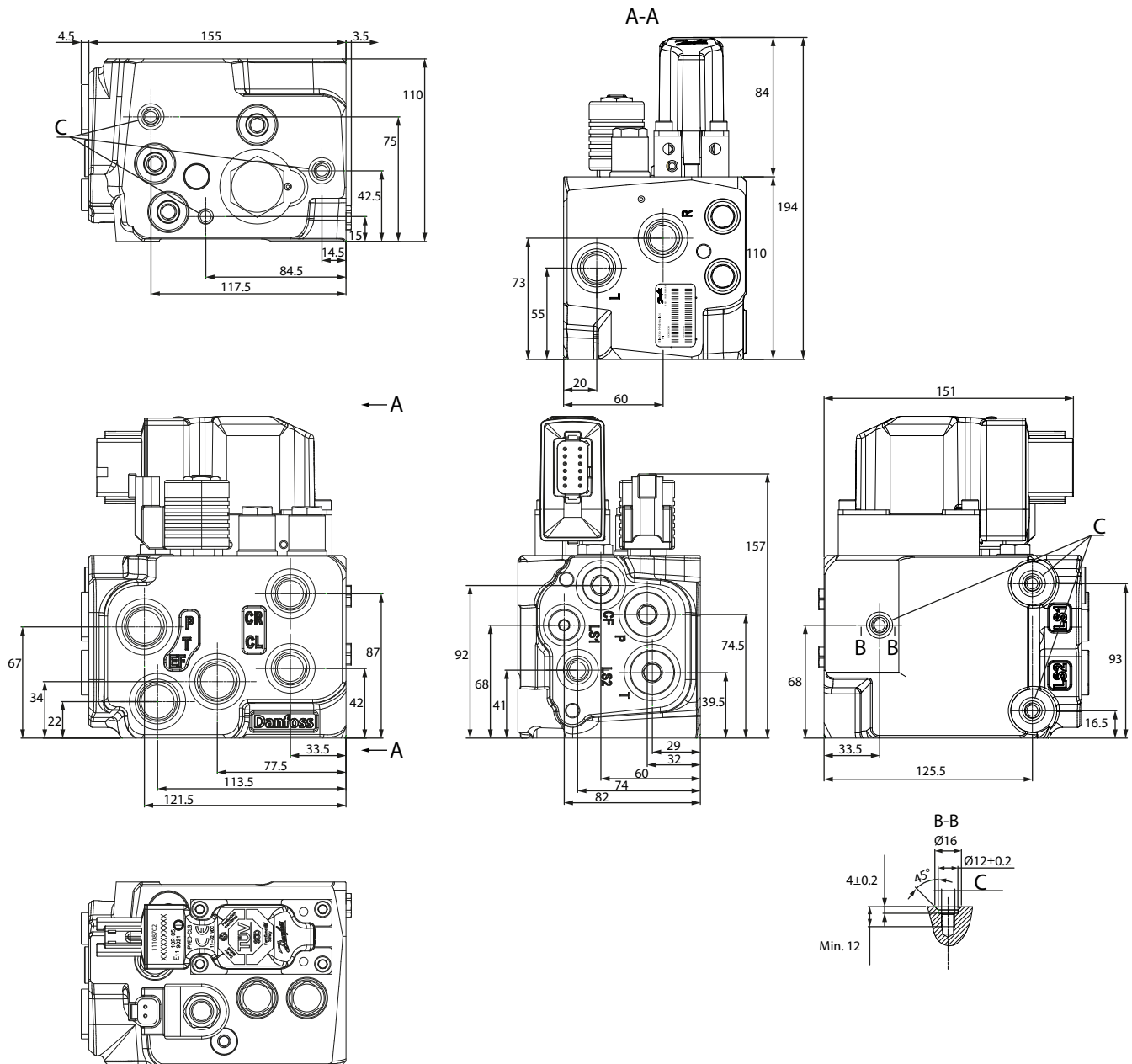

*Metric-port version (ISO 6149-1)*

<b>P, T, EF</b>	<b>CL, CR, L, R</b>	<b>LS1, LS2</b>	<b>C</b>
M22 x 1.5 15 mm deep	M18 x 1.5 14.5 mm deep	M12 x 1.5 11.5 mm deep	M8 x 1.25 12 mm deep

## System safety

### Emergency steering

Steering systems with EHi steering valve and OSP steering unit:

In case of no steering pump supply, the OSP steering unit can be used for emergency steering. The gear wheel set acts as a hand driven pump, and so muscle power will be converted from input torque and rotation on the steering wheel to hydraulic power in the form of pressure and flow out of the cylinder port to which side the steering is done.

Look in *General, Steering Components Technical Information*, **BC152886484183**, under the General Information chapter, for calculating manual/emergency steering.

For fail-safe Steer By Wire Steering systems only using EHi steering valve, manual activated emergency steering will not be possible. Such steering systems must be set up with complete redundancy, or it must only be used for limited maximum driving speed and only for off road usage.

### EHi and system safety

EHi has built in safety function in form of cut off valve. In starting point this cut off valve is in safe state. Connections from directional valve to cylinder ports are blocked. The cut off valve will only make EH steering possible when the solenoid valve is powered.

The cut off valve controls the pilot pressure to the PVE actuator. If there isn't any power on the solenoid valve, there isn't any pilot supply to the PVE to move the directional spool out of neutral.

In addition to electrical control, by means of the solenoid valve, the reaction switch valve (RSV) can be pushed over hydraulically by turning the steering wheel. Through this design, full system pressure is available to force open the RSV.

Disengage is achieved by means of SASA sensor. For EHi configuration numbers EHi-9 and EHi-10, see [EHi standard configurations](#) on page 43. Both RSV and cut off valve (COV) can be pushed over hydraulically by turning the steering wheel. Disengage is achieved by means of EH spool monitoring.

Full system pressure to move spools may be considered a well tried safety principle according to ISO13849-2 annex C, table C.2

PVED--CLS actuator works as a certified Safety Controller. The PVED-CLS directly controls the cut off valve by power on/power off to the solenoid valve. If there is no power to the solenoid valve, the EHi is in *Safe State*.

Integrated safety functions in the PVED-CLS can power off the solenoid valve, and bring the EHi to a safe state. Refer to *PVED-CLS Controller for Electrohydraulic Steering User Manual*, **AQ186886485220**.

PVE actuators PVED-CC or PVES, the cut off valve function must be controlled by a separate controller. For example, vehicle main controller, which must power on/power off the solenoid valve to disable/enable *Safe State* of the EHi valve.

### Safety considerations, On-road operation

PVED-CC and PVES actuators are single string designs with limited on board fault monitoring.

The OEM is responsible to establish the necessary means to inform and de-energize the PVE from the cabin when driving on public roads.

#### **Caution**

Non-conforming steering can affect controllability of the vehicle.

Apply vehicle specific safety monitoring systems that will detect non-conforming steering; issue appropriate warnings; and effectively disable PVED-CC and PVES actuators if necessary. A minimum safety system should include a manual power switch to electrically power off electrohydraulic actuators and the solenoid valves while driving on public roads.

## System safety

### System safety

The PVED-CLS actuator can be de-energized while driving on public roads. A road switch design may be applied to keep the PVED-CLS energized while driving on public roads. Refer to *PVED-CLS Controller for Electrohydraulic Steering User Manual, AQ186886485220*.



## Variants and ordering specifications

### EHi Master Model Code (MMC) breakdown

To create the MMC, visit the Danfoss Design Center Configurator for EHi.

#### Example model code

EHI-20-W1-W-N-S-H-EF-S-10-N-E-A-AA-S-N-P-P-S-P-N-S-CLSA-AA-202-NN-NN-D-12-150-210-S-B-G-N-NN-DS-PB-SWID001182

#### Model code position

0	-	1	-	2	-	3	-	4	...
EHI	-	20	-	W1	-	W	-	N	...

#### Position reference

Position	Component	Position	Component
0	Product type	20	L and R ports
1	Electrohydraulic flow, nominal	21	CF ports
2	Circuit type	22	PVE actuator
3	Pilot unit type	23	Firmware type
4	Disengage	24	Firmware revision
5	LS1 signal (external)	25	Firmware package
6	Integrated priority valve	26	Additional information
7	Excess flow	27	Cut-off coil connector
8	Integrated priority valve type	28	Cut-off coil voltage
9	Integrated PV spring	29	Relief valve setting
10	Pressure resolver (PVFC)	30	Shock valves setting
11	Relief valve connection	31	Dynamic orifice
12	Ports standard	32	PP orifice
13	Ports sizing	33	LS orifice
14	LS1 port	34	Reaction switch
15	LS2 port	35	Special feature
16	EF port	36	Label
17	P and T front ports	37	Paint
18	P and T side ports	38	Software ID
19	CL and CR ports	-	

## Variants and ordering specifications

### Code numbers

Configuration numbers, in the following table, are referring to matrix description for *EHi standard configurations* on page 43.

Code no.	Conf. no.	MMC*																	
		1	2	3	4	6	7	8	9	10	11	12	22	27	28	29	30	34	37
11179597	EHi-1	30	LD	N	E	N	NN	N	NN	N	S	A	CLSA	D	12	175	NNN	N	PB
11179598	EHi-2	30	OC	N	E	H	EF	E	10	N	S	A	CLSA	D	12	175	NNN	N	PB
11179600	EHi-4	30	LD	N	E	H	ET	D	07	R	S	A	CLSA	D	12	175	NNN	N	PB
11179613	EHi-5	30	LD	N	E	H	EF	D	07	R	S	A	CLSA	D	12	175	230	H	PB
11179614	EHi-6	30	LD	N	E	N	NN	N	NN	R	S	A	CLSA	D	12	175	230	H	PB
11179601	EHi-7	30	W1	W	N	H	EF	S	10	N	E	A	CLSA	D	12	175	230	N	PB
11179595	EHi-9	30	LS/LD	N/R	H	N	NN	N	NN	W	E	A	CLSA	D	12	175	230	H	PB
11179596	EHi-10	30	OC	N/R	H	H	EF	D	07	W	E	A	CLSA	D	12	175	230	H	PB

\* Not all positions are shown; only key positions which differentiate standard configurations

EHi standard configurations are primarily defined by circuit type, pilot unit type, and disengage method. See *Versions, examples* on page 9 for schematics and details. See *Parts and variants* on page 7 for a breakdown of these options.

## Variants and ordering specifications

### EHi standard configurations

Configurations	OEM installation					SBW / 4WS	GPS Universal	
	EHi-1	EHi-2	EHi-4	EHi-5	EHi-6	EHi-7	EHi-9 <sup>1</sup>	EHi-10 <sup>1</sup>
Hydraulic Circuit	Load Sensing	Open Center	Load Sensing	Load Sensing Reaction	Load Sensing Reaction	SBW fail-safe / 4 Wheel Steering	Load Sensing(Static and Dynamic) With/ Without Reaction	Open Center With/ Without Reaction
Feature								
Cut-off valve	•	•	•	•	•	•	•	•
Relief valve	•	•	•	•	•	•	•	•
Priority valve		•	•	•		•		•
Shock-suction valves				•	•	•	•	•
PVFC LS resolver valve	•		•	•	•		•	•
Reaction Switch Valve for reaction (RSV)				•	•		•	•
OSP override on RSV				•	•		•	•
LS shuttle (SBW or 2WS)								
EF and T internally connected			•					
Disengage without SASA(hydraulic disengage) <sup>2</sup>							•	•
Electrical disengage, for example, by SASA	•	•	•	•	•	•		

<sup>1</sup> Contact Danfoss Power Solutions for more information.

<sup>2</sup> Variable steer mode is not available when using hydraulic disengage.

### Products we offer:

- Cartridge valves
- DCV directional control valves
- Electric converters
- Electric machines
- Electric motors
- Gear motors
- Gear pumps
- Hydraulic integrated circuits (HICs)
- Hydrostatic motors
- Hydrostatic pumps
- Orbital motors
- PLUS+1® controllers
- PLUS+1® displays
- PLUS+1® joysticks and pedals
- PLUS+1® operator interfaces
- PLUS+1® sensors
- PLUS+1® software
- PLUS+1® software services, support and training
- Position controls and sensors
- PVG proportional valves
- Steering components and systems
- Telematics

**Danfoss Power Solutions** is a global manufacturer and supplier of high-quality hydraulic and electric components. We specialize in providing state-of-the-art technology and solutions that excel in the harsh operating conditions of the mobile off-highway market as well as the marine sector. Building on our extensive applications expertise, we work closely with you to ensure exceptional performance for a broad range of applications. We help you and other customers around the world speed up system development, reduce costs and bring vehicles and vessels to market faster.

Danfoss Power Solutions – your strongest partner in mobile hydraulics and mobile electrification.

### Go to [www.danfoss.com](http://www.danfoss.com) for further product information.

We offer you expert worldwide support for ensuring the best possible solutions for outstanding performance. And with an extensive network of Global Service Partners, we also provide you with comprehensive global service for all of our components.

Local address:

### Hydro-Gear

[www.hydro-gear.com](http://www.hydro-gear.com)

### Daikin-Sauer-Danfoss

[www.daikin-sauer-danfoss.com](http://www.daikin-sauer-danfoss.com)

**Danfoss  
Power Solutions (US) Company**  
2800 East 13th Street  
Ames, IA 50010, USA  
Phone: +1 515 239 6000

**Danfoss  
Power Solutions GmbH & Co. OHG**  
Krokamp 35  
D-24539 Neumünster, Germany  
Phone: +49 4321 871 0

**Danfoss  
Power Solutions ApS**  
Nordborgvej 81  
DK-6430 Nordborg, Denmark  
Phone: +45 7488 2222

**Danfoss  
Power Solutions Trading  
(Shanghai) Co., Ltd.**  
Building #22, No. 1000 Jin Hai Rd  
Jin Qiao, Pudong New District  
Shanghai, China 201206  
Phone: +86 21 2080 6201

Danfoss can accept no responsibility for possible errors in catalogues, brochures and other printed material. Danfoss reserves the right to alter its products without notice. This also applies to products already on order provided that such alterations can be made without subsequent changes being necessary in specifications already agreed. All trademarks in this material are property of the respective companies. Danfoss and the Danfoss logotype are trademarks of Danfoss A/S. All rights reserved.