

Assembly and Maintenance Manual

Type CSK, CSK..P, CSK..PP, CSK..2RS, CSK..P2RS

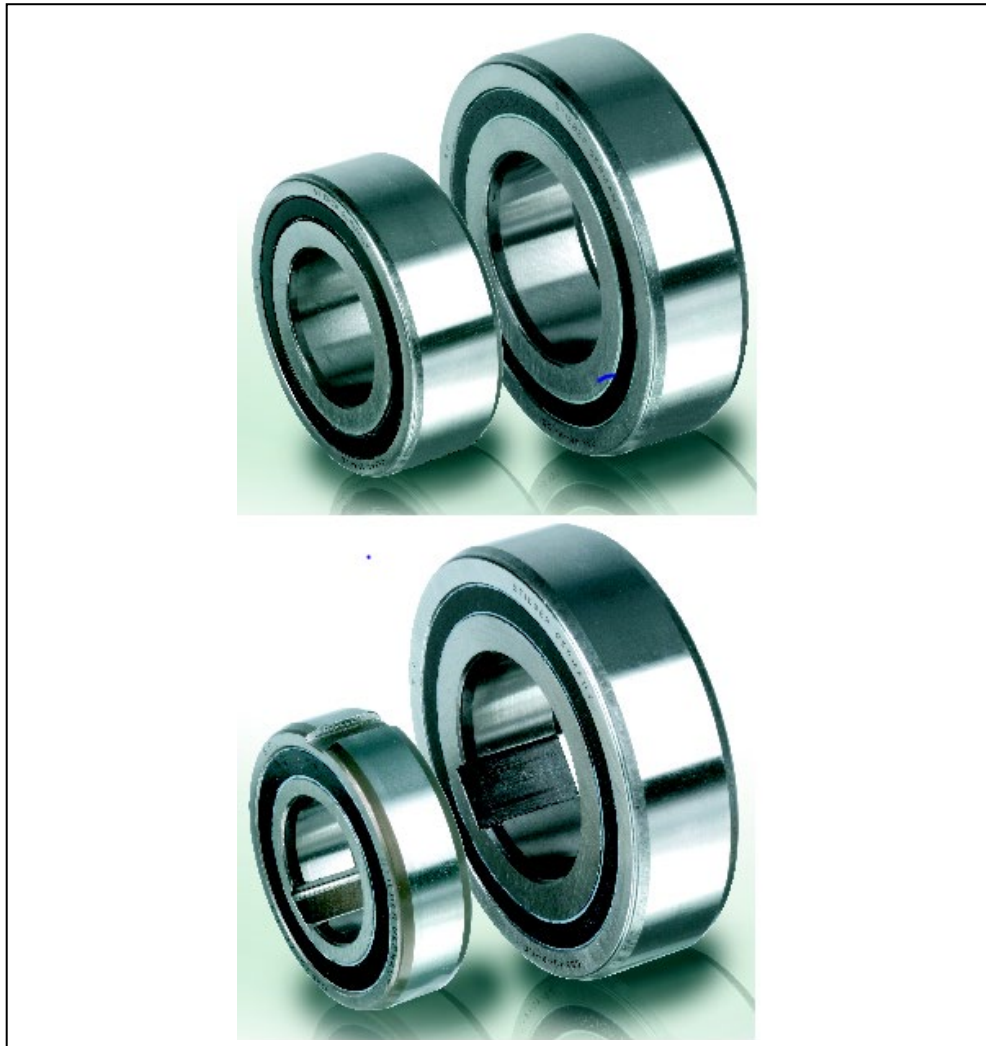

 **STIEBER**[™]
A REGAL REXNORD BRAND

Hatschekstr.36
69126 Heidelberg
Germany
Tel +49(0)6221 30470
Fax +49(0)6221 304731
info@stieber.de
www.stieber.de

Date of issue: 30.05.2018 GB
Revision: 1 27.03.2024 GB

U:\EngUsers\lProduktDoku\1AAA_Einbauerklaerung_Wartungsanleitung_Konformitaetsserklaerung\1AAA_Wartungsanleitungen\Original_Worddatei\M1010E_1_CSK.docx

General safety instructions





	WARNING	<p>Risk of injury due to moving components! Rotating, driven components can cause severe injuries. Therefore, during operation:</p> <ul style="list-style-type: none"> ➤ It is strictly forbidden for persons to loiter in the hazard area or in its immediate vicinity. ➤ Do not disable, render unusable, or circumvent safety equipment and/or safety functions. <p>Prior to entering the hazard area:</p> <ul style="list-style-type: none"> ➤ Switch off the power supply and secure it against being switched on again. ➤ Wait for still moving components to come to a standstill.
	DANGER!	<p>Danger due to improper operation!</p> <ul style="list-style-type: none"> ➤ Modifications to the one-way clutch are not permitted and may impair safety. ➤ All tasks may only be performed by personnel with the requisite training and expertise. ➤ Repairs and maintenance tasks may only be performed when the machine is at a standstill. The machine is therefore to be secured against a restart.
	WARNING	<p>Risk of injury due to the one-way clutch falling down or tipping over! The weight of the one-way clutch can injure people and cause severe crushing. Therefore:</p> <ul style="list-style-type: none"> ➤ When lifting, use suitable lifting gear (slings, etc.) able to support the weight of the one-way clutch.
	WARNING	<p>Risk of injury due to incorrect assembly! Incorrect assembly and maintenance can cause severe property damage and personal injury. Assembly, maintenance, and repair work may only be performed by personnel with the requisite training and expertise.</p>
	WARNING	<p>Risk of injury for insufficiently qualified personnel! Improper handling can cause significant personal injury and property damage. Therefore:</p> <ul style="list-style-type: none"> ➤ Only ever have tasks performed by those persons to whom the tasks have been assigned.

Table of contents		Page
General safety instructions		2
1 General.....		4
1.1 Information relating to the assembly and maintenance manual		4
1.2 Explanation of symbols		4
1.3 Manufacturer.....		5
1.4 Labeling		5
1.5 Environmental protection		5
2 Safety		5
2.1 Intended use		5
2.2 Responsibility of the operator.....		6
2.3 Assembly and maintenance personnel.....		7
2.4 Personal protective equipment.....		7
2.5 Limitations of use		7
3 Structure and function		8
3.1 Structure		8
3.2 Functional principle		9
4 Transport and packaging.....		11
5 Storage.....		11
5.1 Short-term storage		11
5.2 Long-term storage.....		11
6 Installation		12
6.1 Checking the direction of rotation.....		12
6.2 Lubrication		12
6.3 Assembly		13
6.4 Changing the direction of rotation.....		14
6.5 Mounting example.....		15
7 Disassembly		15
8 Disposal		16
9 Faults		16

1 General

1.1 Information relating to the assembly and maintenance manual

This assembly and maintenance manual provides important information regarding the installation and commissioning of the one-way clutches of types CSK, CSK..P, CSK..PP, CSK..2RS, CSK..P2RS.





The prerequisite for safe operation is compliance with all of the stated safety and handling instructions.

Moreover, the relevant local accident protection guidelines and general safety provisions for the field of application of the one-way clutch are to be complied with.

Read the assembly and maintenance manual carefully prior to installation and commissioning. The manual is a product component and must be kept in the immediate vicinity of the installation site and be accessible to personnel at all times. Furthermore, all safety instructions stated in the assembly and maintenance manual are to be observed.

1.2 Explanation of symbols

Warnings are marked throughout this assembly and maintenance manual by symbols. These warnings are introduced by signal words that indicate the extent of the danger. Comply with the warnings under all circumstances and act with due care and attention to avoid accidents, personal injury, and property damage.

	DANGER!	...indicates an imminently dangerous situation that can be fatal or cause severe injuries if it is not averted.
	WARNING	...indicates a potentially dangerous situation that can be fatal or cause severe injuries if it is not averted.
	ATTENTION	...indicates a potentially dangerous situation that can cause minor or light injuries if it is not averted.
	CAUTION	...indicates a potentially dangerous situation that can cause property damage if it is not averted.
	NOTICE	... highlights helpful tips and recommendations as well as information for efficient and trouble-free operation.

1.3 Manufacturer

STIEBER GMBH, D-69126 Heidelberg, Hatschekstr. 36, Germany
Phone +49 (0) 6221 3047-0, Fax -31

1.4 Labeling

External surface of the outer ring

- Manufacturer
- Type designation
- Date of manufacture (coded)

1.5 Environmental protection

Energy: The one-way clutch does not use any electrical energy.

Materials: Steel, (bolts possibly with brass)

Recycling: Steel parts are up to 100% recyclable.

2 Safety

2.1 Intended use

One-way clutches of types CSK, CSK..P, CSK..PP, CSK..2RS, CSK..P2RS are automatically switching clutches dependent on the direction of rotation. They are used as overrunning clutches, backstops, or switching clutches in machines and systems.

One-way clutches may only be operated within the limitations of use outlined in Section 2.5.

All of the specifications stated in the assembly and maintenance manual must be strictly adhered to.

Any claims due to damage arising from improper use are excluded. The operator bears sole liability for all damage arising from improper use.

Driving operation of an overrunning clutch:

When the driving machine elements are operated in the pulling direction, the driving machine element and the torque-supporting machine element are connected to each other in a force-locked manner by the overrunning clutch. In this operating state, output can be transmitted.

Overrun operation of an overrunning clutch:

The overrunning clutch automatically releases the force-locked connection of the driving machine element and the driven machine element if the torque of the driven machine element is higher than that of the driving machine element.

Lockout operation of a backstop:

When the machine shaft is operated in the reverse direction, the machine shaft and the torque-supporting machine element are connected to each other in a force-locked manner by the one-way clutch. In this operating state, a torque is transmitted.

Overrun operation of a backstop:

The one-way clutch automatically releases the force-locked connection between the machine shaft and the torque-supporting machine element, providing the machine shaft is operated in the overrun direction.

Driving operation of an indexing clutch:

When the machine shaft is operated in the pulling direction, the machine shaft and the torque-supporting machine element are connected to each other in a force-locked manner by the one-way clutch. In this operating state, an output is transmitted.

Idling operation of an indexing clutch:

The one-way clutch automatically releases the force-locked connection between the machine shaft and the torque-supporting machine element, providing the machine shaft is operated in the idling direction.

2.2 Responsibility of the operator

The operator of the system in which the one-way clutch is installed is subject to the legal obligations concerning occupational safety.

The valid provisions for the site of operation as well as the safety and accident prevention regulations of the trade association are to be observed. In particular, this means that the operator:

- is aware of the valid occupational safety provisions
- implements at the site of operation the necessary behavioral requirements for operation of the system in which the one-way clutch is installed
- clearly defines responsibilities for installation, operation, maintenance, and cleaning of the system in which the one-way clutch is installed
- ensures that all staff members who work at or with the system in which the one-way clutch is installed have read and understood the operation manual. Moreover, the operator must, at regular intervals, provide training for personnel on how to handle the system in which the one-way clutch is installed, and inform them of the potential dangers. In addition, the operator is responsible for ensuring that the system in which the one-way clutch is installed:
 - is always in perfect technical condition

- is maintained in accordance with the specified maintenance intervals
- has all its safety equipment checked regularly for completeness and functionality

2.3 Assembly and maintenance personnel

	WARNING	<p>Risk of injury for insufficiently qualified personnel! Improper handling can cause significant personal injury and property damage. Therefore:</p> <ul style="list-style-type: none"> ➤ Only ever have tasks performed by those persons to whom the tasks have been assigned.
---	----------------	--

Qualified personnel are those persons who, owing to their training, experience, and instruction as well as their knowledge of relevant standards, provisions, accident prevention regulations and operating conditions, have been authorized by the person responsible for the safety of the system to perform the requisite tasks and are able to recognize and avoid potential dangers in doing so. Knowledge of first-aid measures and on-site emergency equipment is also required.

2.4 Personal protective equipment

In order to minimize health risks, it is necessary to wear personal protective equipment when handling the system in which the one-way clutch is installed.

Above all, the necessary protective equipment such as work shoes, gloves, safety goggles, etc. is to be put on prior to all tasks and kept on during the task.

2.5 Limitations of use

- Maximum permissible overrun rotation speeds and maximum permissible torques:

Type CSK/ CSK..2RS CSK..P/ CSK..PP	Bore	Max. Torque [Nm]	n max [rpm]	Bearing loads	
				dynamic [kN]	static c ₀ [kN]
8	8	5	15000	3,28	0,86
12	12	18,6	10000	6,1	2,77
15	15	34	8400	7,4	3,42
17	17	60	7350	7,9	3,8
20	20	100	6000	9,4	4,46
25	25	170	5200	10,7	5,46
30	30	276	4200	11,7	6,45
35	35	350	3600	12,6	7,28
40	40	650	3000	15,54	12,25

Table 1 Specificatio

- Limits for ambient temperature: 5°C bis +60°C
- Max. operating temperature: 90°C
- Machine shaft tolerance CSK/ CSK..2RS: d = n6
- Machine shaft tolerance CSK..P/
CSK..PP/ CSK..P-2RS: d = h6
- erforderliche Toleranz Stahlgehäuse
CSK/ CSK..2RS/ CSK..P/ CSK..P2RS: d = N6
- the necessary press fit tolerance of the outer race in a stable steel housing
CSK..PP: d = H6
- Grease lubrication: lubricated for life with Klüber Polylub WH-2

3 Structure and function

3.1 Structure

Item 1	Outer race
Item 2	Inner race
Item 3	Sprag
Item 4	Cage
Item 7	Gasket
Pos. 8	Bearing

Tab.2 Part list

The CSK, CSK..P, CSK..PP, CSK..2RS, CSK..P2RS types are integrated into a 62 series ball bearing (except sizes 8 and 40).

They are bearing supported, delivered grease lubricated.

CSK, CSK..P, CSK..PP types protect against dust of more than 0,3

CSK..2RS, CSK..P2RS types are equipped with lip seals which prevent lubricants from flowing out.

CSK..2RS, CSK..P2RS types are 5 mm wider than the 62 series ball bearing.

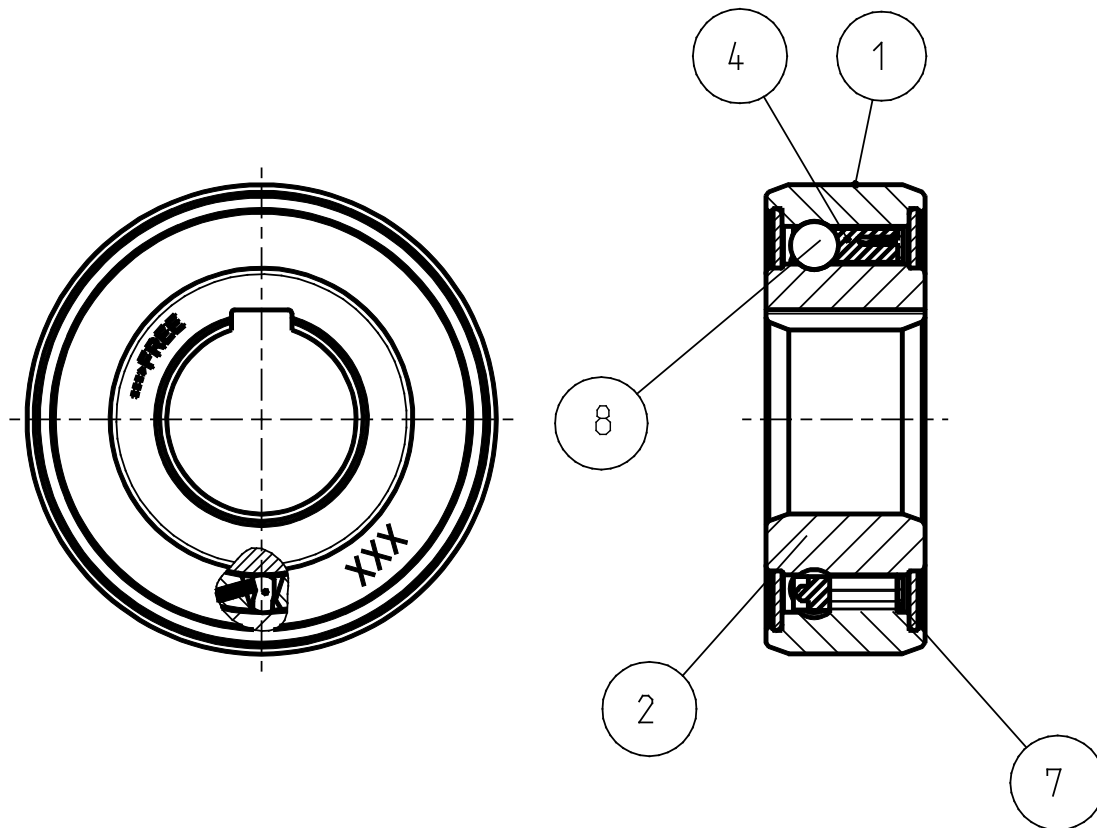

Figure 1 Freewheel CSK..P

(Type CSK – without keyway on the inner race

Type CSK..PP – with additional keyway on the outer race)

3.2 Functional principle

The outer race (1) and inner race (2) are connected in force-locking manner during the torque transmission over the one-way-clutch.

To this end, the clamping elements will be used whose outward contours provides a force-locking connection.

The clamping elements are enclosed in a cage and will be pressed by springs in contact with outer and inner race. The springs results in fast one-way-clutch response at the beginning of the torque transmission.

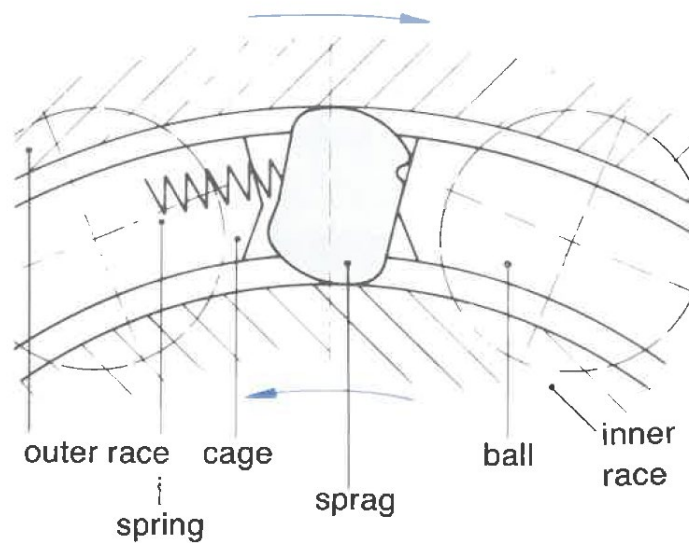

Figure 2a Torque transmission

Overrun operation is carried out if the outer race or inner race is turned in the overrun direction. This interrupts the frictional connection (see Fig. 2b) between the inner and outer race. In overrun operation the speeds of the inner race and outer race are different.

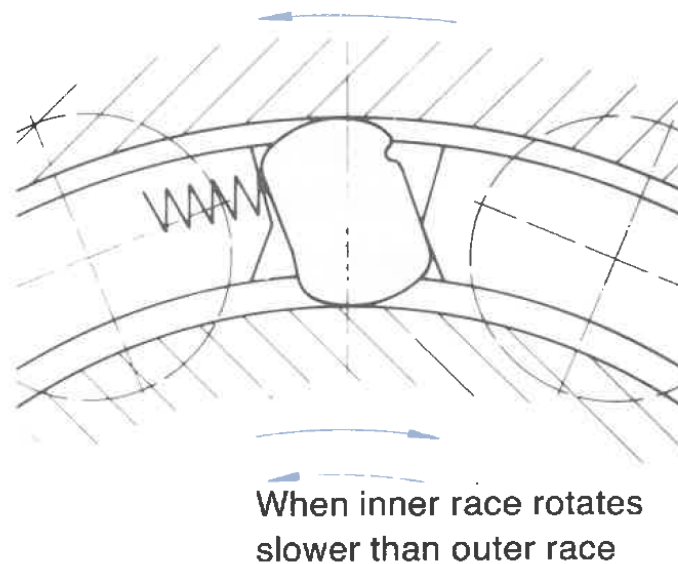

Figure 2b Overrunning

4 Transport and packaging



NOTICE

The local provisions regarding the disposal of transport and packaging materials are to be observed.

The one-way clutch is sealed in PE foil and shipped in a box.

Transport damage to the packaging and/or the one-way clutch is to be reported to the respective transit company without delay.

The one-way clutch must be unpacked in a clean and dry environment.

5 Storage

5.1 Short-term storage

The CSK, CSK..P, CSK..PP, CSK..2RS, CSK..P2RS types are provided with factory-applied oil film as corrosion protection. The corrosion protection is to be renewed at regular intervals. The frequency of these intervals is dependent on the environmental conditions (temperature, moisture, salt content of the air, etc.) at the storage site.

The maximum storage period (short-term storage) is 6 months. Moreover, the backstop must have long-term storage corrosion protection applied to it.

Store packages under the following conditions:

- Do not keep outdoors
- Keep dry and free from dust
- Do not expose to aggressive media
- Keep away from direct sunlight
- Avoid mechanical shocks and vibrations
- Storage temperature: -10 to +60°C
- Relative humidity: max. 95%, non-condensing

5.2 Long-term storage



For long-term storage, the one-way clutch must be shrink-wrapped with a desiccant and provided with a hygroscope. The corrosion protection must be checked after a period not exceeding one year or else depending on the environmental conditions (temperature, moisture, salt content of the air, etc.) at the storage site.

Store packages under the following conditions:

- Do not keep outdoors
- Keep dry and free from dust
- Do not expose to aggressive media
- Keep away from direct sunlight
- Avoid mechanical shocks and vibrations
- Storage temperature: -10 to +60°C
- Relative humidity: max. 95%, non-condensing

6 Installation

6.1 Checking the direction of rotation





	WARNING	<p>Risk of injury due to incorrect assembly! Incorrect assembly and maintenance can cause severe property damage and personal injury. Assembly, maintenance, and repair work may only be performed by personnel with the requisite training and expertise.</p>
	WARNING	<p>Risk of injury due to moving components! Rotating, driven components can cause severe injuries. Therefore, during operation:</p> <ul style="list-style-type: none"> ➤ It is strictly forbidden for persons to loiter in the hazard area or in its immediate vicinity. ➤ Do not disable, render unusable, or circumvent safety equipment and/or safety functions. <p>Prior to entering the hazard area:</p> <ul style="list-style-type: none"> ➤ Switch off the power supply and secure it against being switched on again. ➤ Wait for still moving components to come to a standstill.
	WARNING	<p>Risk of injury for insufficiently qualified personnel! Improper handling can cause significant personal injury and property damage. Therefore:</p> <ul style="list-style-type: none"> ➤ Only ever have tasks performed by those persons to whom the tasks have been assigned.

Before installation, the direction of rotation of the one-way clutch must be checked.

6.2 Lubrication

The one-way clutch is filled with grease. No relubrication is required.

6.3 Assembly

	WARNING	<p>Risk of injury due to incorrect assembly!</p> <p>Incorrect assembly and maintenance can cause severe property damage and personal injury.</p> <p>Assembly, maintenance, and repair work may only be performed by personnel with the requisite training and expertise.</p>
	WARNING	<p>Risk of injury due to moving components!</p> <p>Rotating, driven components can cause severe injuries. Therefore, during operation:</p> <ul style="list-style-type: none"> ➤ It is strictly forbidden for persons to loiter in the hazard area or in its immediate vicinity. ➤ Do not disable, render unusable, or circumvent safety equipment and/or safety functions. <p>Prior to entering the hazard area:</p> <ul style="list-style-type: none"> ➤ Switch off the power supply and secure it against being switched on again. ➤ Wait for still moving components to come to a standstill.
	WARNING	<p>Risk of injury due to falling components!</p> <p>Falling components can lead to serious injuries to persons.</p> <p>Secure the one-way clutch against falling down.</p>
	WARNING	<p>Risk of injury for insufficiently qualified personnel!</p> <p>Improper handling can cause significant personal injury and property damage. Therefore:</p> <ul style="list-style-type: none"> ➤ Only ever have tasks performed by those persons to whom the tasks have been assigned.

Procedural steps:

- Press or push (with keyway) the inner and outer race simultaneously. Use appropriate mounting tools (see Fig.3), whereby the tool should be provided with an undercut for the plastic cage.

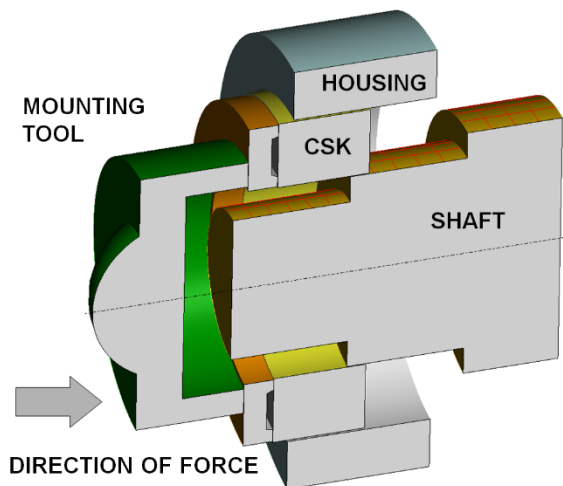

Figure 3: Mounting tool

i	NOTE	Do not tighten the one way-clutch components against one another! When installed, the plastic cage or seals must not contact surrounding parts.
----------	-------------	--

- Fasten the one-way clutch axially.
- Check overrunning. After the assembly, the one-way clutch must be easy to turn in the overrun direction of rotation.

6.4 Changing the direction of rotation

The direction of rotation is changed by reversing the one-way clutch.

Procedural steps:

- Remove the axial fixing.
- Pull the one-way clutch using an assembly tool Use suitable lifting gear for this. Make sure that the inner and outer race will be pulled at the same time to prevent possible damage to the bearing.
- Reverse the one-way clutch.
- Press or push (with keyway) the inner and outer race simultaneously. Use appropriate mounting tools (see Fig.3), whereby the tool should be provided with an undercut for the plastic cage.

i	NOTE	Do not tighten the one way-clutch components against one another! When installed, the plastic cage or seals must not contact surrounding parts.
----------	-------------	--

- Fasten the one-way clutch axially.

- Check overrunning. After the assembly, the one-way clutch must be easy to turn in the overrun direction of rotation.

6.5 Mounting example

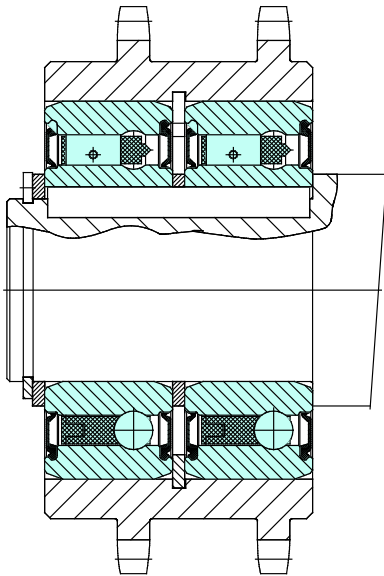



Figure 4: Installation example

7 Disassembly

	<p>WARNING</p>	<p>Risk of injury due to incorrect assembly! Incorrect assembly and maintenance can cause severe property damage and personal injury. Assembly, maintenance, and repair work may only be performed by personnel with the requisite training and expertise.</p>
	<p>WARNING</p>	<p>Risk of injury due to moving components! Rotating, driven components can cause severe injuries. Therefore, during operation:</p> <ul style="list-style-type: none"> ➤ It is strictly forbidden for persons to loiter in the hazard area or in its immediate vicinity. ➤ Do not disable, render unusable, or circumvent safety equipment and/or safety functions. <p>Prior to entering the hazard area:</p> <ul style="list-style-type: none"> ➤ Switch off the power supply and secure it against being switched on again. ➤ Wait for still moving components to come to a standstill.

**WARNING****Risk of injury due to falling components!**

Falling components can lead to serious injuries to persons.
Secure the one-way clutch against falling down.

Procedural steps:

- Remove the axial fixing.
- Remove the one-way clutch using an auxiliary tool.

8 Disposal

**NOTICE**

The local provisions regarding the disposal of metallic components and any lubricants present are to be observed.

The one-way clutch is comprised of metallic materials that are coated with grease or oil. Metallic materials are fully recyclable. Lubricants and anticorrosive agents are to be disposed of separately. The local disposal provisions are to be observed in this regard.

9 Faults

The manufacturer is to be contacted immediately should any faults arise.

STIEBER GMBH, D-69126 Heidelberg, Hatschekstr. 36, Germany
Phone +49 (0) 6221 3047-0, Fax -31