

Assembly and Maintenance Manual

Types RIZ/ RINZ/ RIZ..G1G2/ RIZ..G2G7/

RINZ..G5G5/ RIZ..G2G3/ RIZ..G3G4/

RIZ..ESG2/ RIZ..ELG2



 **STIEBER**[™]
A REGAL REXNORD BRAND

Hatschekstr. 36
69126 Heidelberg
Germany
Phone +49(0)6221 30470
Phone +49(0)6221 304731
info@stieber.de
www.stieber.de

Date of issue: 1.03.2017 GB
Revision:4 03/08/2023 GB

U:\EngUsers\ProduktDoku\1AAA_Einbauerklaerung_Wartungsanleitung_Konformitaetszertifizierung\1AAA_Wartungsanleitungen\Original_Worddatei\M1070E_4_RIZ_RINZ_RIZ..G1G2_RIZ..G2G7_RINZ..G5G5_RIZ..G2G3_RIZ..G3G4_RIZ..ESG2_RIZ..ELG2.docx

General safety instructions





	WARNING	<p>Danger of injury due to moving components! Rotating, driven components can cause severe injuries. Therefore, during operation:</p> <ul style="list-style-type: none"> ➤ It is strictly forbidden for persons to loiter in the hazard area or in its immediate vicinity. ➤ Do not disable, render unusable, or circumvent safety equipment and/or safety functions. <p>Prior to entering the hazard area:</p> <ul style="list-style-type: none"> ➤ Switch off the power supply and secure it against being switched on again. ➤ Wait for still moving components to come to a standstill.
	DANGER!	<p>Danger due to improper operation!</p> <ul style="list-style-type: none"> ➤ Modifications to the one-way clutch are not permitted and may impair safety. ➤ All tasks may only be performed by personnel with the requisite training and expertise. ➤ Repairs and maintenance tasks may only be performed when the machine is at a standstill. The machine is therefore to be secured against a restart.
	WARNING	<p>Danger of injury due to the one-way clutch falling down or tipping over! The weight of the one-way clutch can injure people and cause severe crushing. Therefore:</p> <ul style="list-style-type: none"> ➤ When lifting, use suitable lifting gear (slings, etc.) able to support the weight of the one-way clutch.
	WARNING	<p>Danger of injury due to incorrect assembly! Incorrect assembly and maintenance can cause severe property damage and personal injury. Assembly, maintenance, and repair work may only be performed by personnel with the requisite training and expertise.</p>
	WARNING	<p>Danger of injury for insufficiently qualified personnel! Improper handling can cause significant personal injury and property damage. Therefore:</p> <ul style="list-style-type: none"> ➤ Only ever have tasks performed by those persons to whom the tasks have been assigned.

Table of contents	Page
General safety instructions	2
1 General.....	5
1.1 Information relating to the assembly and maintenance manual	5
1.2 Explanation of symbols	5
1.3 Manufacturer.....	6
1.4 Labeling	6
1.5 Environmental protection	6
2 Safety	6
2.1 Intended use	6
2.2 Responsibility of the operator.....	7
2.3 Assembly and maintenance personnel.....	8
2.4 Personal protective equipment.....	8
2.5 Limitations of use	8
3 Structure and function	15
3.1 Structure	15
3.2 Functional principle	19
4 Transport and packaging.....	20
5 Storage.....	20
5.1 Short-term storage	20
5.2 Long-term storage.....	21
6 Installation	21
6.1 Checking the direction of rotation	21
6.2 Changing the direction of rotation.....	22
6.3 Lubrication	23
6.4 Assembly	23
6.4.1 Installation of one-way clutch RIZ/ RINZ	23
6.4.2 Installation of RIZ..G1G2 one-way clutch	24
6.4.3 Installation of RIZ..G2G7 one-way clutch	25
6.4.4 Installation of RINZ..G5G5 one-way clutch.....	26
6.4.5 Installation of RIZ..ELG2 one-way clutch.....	26
6.4.6 Installation of RIZ..ESG2 one-way clutch	29
7 Maintenance	29
7.1 Test criteria in case of need for maintenance.....	30
7.2 Assembly in case of need for maintenance.....	31

7.3	Maintenance and replacement of the elastic elements of the EL clutch.....	33
7.4	Maintenance and replacement of the elastic elements of the ES clutch	33
8	Disassembly	35
9	Disposal	36
10	Faults	36
11	Spare parts	36

1 General

1.1 Information relating to the assembly and maintenance manual

This assembly and maintenance manual provides important information regarding the installation and start-up of the one-way clutches of the types RIZ/ RINZ/ RIZ..G1G2/ RIZ..G2G7/ RINZ..G5G5/ RIZ..G2G3/ RIZ..G3G4/ RIZ..ESG2/ RIZ..ELG2.





The prerequisite for safe operation is compliance with all of the stated safety and operating instructions.

Moreover, the relevant local accident prevention regulations and general safety provisions for the field of application of the one-way clutch are to be complied with.

Read the assembly and maintenance manual carefully prior to installation and start-up. This manual is a product component and must be kept in the immediate vicinity of the installation site and be accessible to personnel at all times. Furthermore, all safety instructions stated in the assembly and maintenance manual are to be observed.

1.2 Explanation of symbols

Warnings are marked throughout this assembly and maintenance manual by symbols. These warnings are introduced by signal words that indicate the extent of the hazard. Comply with the warnings under all circumstances and act with due care and attention to avoid accidents, personal injury, and property damage.

	DANGER!	...indicates an imminently dangerous situation that can be fatal or cause severe injuries if it is not averted.
	WARNING	...indicates a potentially dangerous situation that can be fatal or cause severe injuries if it is not averted.
	ATTENTION	...indicates a potentially dangerous situation that can cause minor or light injuries if it is not averted.
	CAUTION	...indicates a potentially dangerous situation that can cause property damage if it is not averted.
	NOTICE	... highlights helpful tips and recommendations as well as information for efficient and trouble-free operation.

1.3 Manufacturer

STIEBER GMBH, D-69126 Heidelberg, Hatschekstr. 36, Germany
Phone +49 (0) 6221 3047-0, Fax -31

1.4 Labeling

External surface of the outer race

- Manufacturer
- Type designation
- Date of manufacture (coded)

1.5 Environmental protection

Energy: The one-way clutch does not use any electrical energy.

Materials: Steel

Recycling: Steel parts are up to 100% recyclable.

2 Safety

2.1 Intended use

One-way clutches of types RIZ/ RINZ/ RIZ..G1G2/ RIZ..G2G7/ RINZ..G5G5/ RIZ..G2G3/ RIZ..G3G4/ RIZ..ESG2/ RIZ..ELG2 are automatically switching couplings dependent on the direction of rotation. They are used as overrunning clutches, backstops, or switching clutches in machines and systems.

One-way clutches may only be operated within the limitations of use outlined in Section 2.5.

All of the specifications stated in the assembly and maintenance manual must be strictly adhered to.

Any claims due to damage arising from improper use are excluded. The operator bears sole liability for all damage arising from improper use.

Driving operation of an overrunning clutch:

When the driving machine elements are operated in the pulling direction, the driving machine element and the torque-supporting machine element are connected to each other in a force-locked manner by the overrunning clutch. In this operating state, output can be transmitted.

Overrun operation of an overrunning clutch:

The overrunning clutch automatically releases the force-locked connection of the driving machine element and the driven machine element if the torque of the driven machine element is higher than that of the driving machine element.

Lockout operation of a backstop:

When the machine shaft is operated in the reverse direction, the machine shaft and the torque-supporting machine element are connected to each other in a force-locked manner by the one-way clutch. In this operating state, a torque is transmitted.

Overrun operation of a backstop:

The one-way clutch automatically releases the force-locked connection between the machine shaft and the torque-supporting machine element, providing the machine shaft is operated in the overrun direction.

Driving operation of an indexing clutch:

When the machine shaft is operated in the pulling direction, the machine shaft and the torque-supporting machine element are connected to each other in a force-locked manner by the one-way clutch. In this operating state, an output is transmitted.

Idling operation of an indexing clutch:

The one-way clutch automatically releases the force-locked connection between the machine shaft and the torque-supporting machine element, providing the machine shaft is operated in the idling direction.

2.2 Responsibility of the operator

The operator of the system in which the one-way clutch is installed is subject to the legal obligations concerning occupational safety.

The valid provisions for the site of operation as well as the safety and accident prevention regulations of the trade association are to be observed. In particular, this means that the operator:

- is aware of the valid occupational safety provisions.
- implements at the site of operation the necessary behavioral requirements for operation of the machine in which the one-way clutch is installed.
- clearly defines responsibilities for installation, operation, maintenance, and cleaning of the system in which the one-way clutch is installed.
- ensures that all staff members who work at or with the system in which the one-way clutch is installed have read and understood the operation manual. Moreover, the operator must, at regular intervals, provide training for personnel on how to handle the system in which the one-way clutch is installed, and inform them of the potential dangers. In addition, the operator is responsible for ensuring that the system in which the one-way clutch is installed:
 - is always in perfect technical condition.
 - is maintained in accordance with the specified maintenance intervals.
 - has all its safety equipment checked regularly for completeness and functionality.

2.3 Assembly and maintenance personnel

	WARNING	<p>Danger of injury for insufficiently qualified personnel! Improper handling can cause significant personal injury and property damage. Therefore:</p> <ul style="list-style-type: none"> ➤ Only ever have tasks performed by those persons to whom the tasks have been assigned.
---	----------------	--

Qualified personnel are those persons who, owing to their training, experience, and instruction as well as their knowledge of relevant standards, provisions, accident prevention regulations and operating conditions, have been authorized by the person responsible for the safety of the system to perform the requisite tasks and are able to recognize and avoid potential dangers in doing so. Knowledge of first-aid measures and on-site emergency equipment is also required.

2.4 Personal protective equipment

In order to minimize health risks, it is necessary to wear personal protective equipment when handling the system in which the one-way clutch is installed.

Above all, the necessary protective equipment such as work shoes, gloves, safety goggles, etc. is to be put on prior to all tasks and kept on during the task.

2.5 Limitations of use

- Maximum permissible overrun rotational speeds and maximum permissible torques (grease amount)

Type	Dimensions* Hole Ø [mm] H7	Max. torque [Nm]	Min. Overrun rotational speed Inner race [rpm]	Max. Overrun rotational speed Inner race [rpm]	Max. Pulling rotational speed [rpm]	Grease amount [cm ³]	Bearing type
RIZ/ RINZ	30	750	700	9000	290	8	6009
	35	1100	670	8500	280	9	6010
	40	1600	630	7500	260	11	6011
	45	1824	610	6700	255	12	6012
	50	2800	560	6000	235	16	6014
	60	4700	510	5300	210	30	6016
	70	6100	470	4000	195	40	6018
	80	11600	375	4000	155	45	6021
	90	17400	350	3000	145	55	6024
	100	32000	340	2400	140	100	6028
	130	46000	320	2400	130	130	6032
	150	100000	220	1300	90	495	16040

*Special hole and reinforced spring design RIZ/ RINZ(..)V and VV
as well as weak suspension RIZ/ RINZ(..)S upon request

Table 1a Specification for centrifugal lift-off one-way clutches

**NOTICE**

If the hole diameter is smaller than the maximum, the maximum torque to be transmitted depends on the fitting key connection.

Type	Dimensions* Hole Ø [mm] H7	Max. torque [Nm]	Min. Overrun rotational speed Inner race [rpm]	Max. Overrun rotational speed Inner race [rpm]	Max. Pulling rotational speed [rpm]	Grease amount [cm ³]	Bearing type
RIZ..G1G2 RIZ..G2G7 RINZ..G5G5	30	750	700	9000	290	8	6009
	35	1,100	670	8500	280	9	6010
	40	1,600	630	7500	260	11	6011
	45	1824	610	6700	255	12	6012
	50	2,800	560	6,000	235	16	6014
	60	4700	510	5300	210	30	6016
	70	6100	470	4,000	195	40	6018
	80	11600	375	4,000	155	45	6021
	90	17400	350	3000	145	55	6024
	100	32000	340	2,400	140	100	6028
	130	46000	320	2,400	130	130	6032
	150	100000	220	1300	90	495	16040

*Special hole and reinforced spring design RIZ /RINZ(..)V
and VW as well as weak suspension RIZ/ RINZ (..)S upon request

Table 1b Specification for centrifugal lift-off one-way clutches

Type	Dimensions* Hole Ø [mm] H7	Max. torque [Nm]	Min. Overrun rotational speed Inner race [rpm]	Max. Overrun rotational speed Inner race [rpm]	Grease amount [cm ³]	Bearing type
RIZ..G2G3 RIZ..G3G4	30	750	700	9000	8	6009
	35	1100	670	8500	9	6010
	40	1600	630	7500	11	6011
	45	1824	610	6700	12	6012
	50	2800	560	6000	16	6014
	60	4700	510	5300	30	6016
	70	6100	470	4000	40	6018
	80	11600	375	4000	45	6021
	90	17400	350	3000	55	6024
	100	32000	340	2400	100	6028
	130	46000	320	2400	130	6032
	150	100000	220	1300	495	16040

*Special hole and reinforced spring design RIZ /RINZ(..)V
and VW as well as weak suspension RIZ/ RINZ (..)S upon request

Table 1c Specification for centrifugal lift-off one-way clutches

**NOTICE**

If the hole diameter is smaller than the maximum, the maximum torque to be transmitted depends on the fitting key connection.

Type	Dimensions* Hole Ø [mm] H7	Clutch size ES	Max. torque [Nm]	Min. Overrun rotational speed Inner race [rpm]	Max. Overrun rotational speed Inner race [rpm]	Max. Pulling rotational speed [rpm]	Grease amount [cm ³]	Bearing type 2Z
RIZ..ESG2	30	10	300	700	9000	290	8	6009
	35	16	500	670	8500	280	9	6010
	40	25	800	630	7500	260	11	6011
	45	40	1250	610	6700	255	12	6012
	50	63	2000	560	6000	235	16	6014
	60	100	3200	510	5300	210	30	6016
	70	160	5000	470	4000	195	40	6018
	80C	250	8000	450	3000	190	45	6021
	80	400	11600	375	4000	155	45	6021
	90C	400	11500	420	2700	180	55	6024
	90	630	17400	350	3000	145	55	6024
	100C	630	19000	455	2300	200	100	6028
	100	1000	32000	340	2400	140	100	6028
	130C	1000	32000	415	2000	180	130	6032
130	1600	46000	320	2400	130	130	6032	

*Special hole and reinforced spring design RIZ..ESG2 V
and VW as well as weak suspension RIZ..ESG2 upon request

Table 2a Specification for centrifugal lift-off one-way clutches with ES clutch and cover G2

Permissible ES clutch displacement

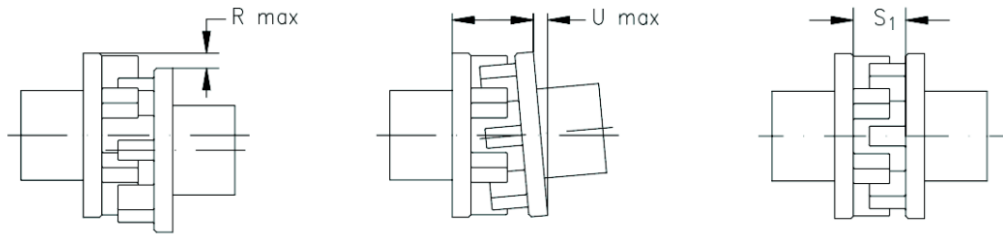

Radial alignment

Angular alignment

Axial alignment

Fig. 1 Alignment tolerances of ES clutches

Size	4	6.3	10	16	25	40	63	100	160	250	400	630	1,000	1,600	2,500
R_{max} [mm]	0.3	0.3	0.3	0.3	0.3	0.4	0.4	0.4	0.4	0.5	0.5	0.6	0.7	0.8	0.8
U_{max} [mm]	0.3	0.3	0.3	0.4	0.4	0.4	0.5	0.6	0.7	0.8	0.9	1	1.1	1.2	1.2
S_{1max} [mm]	18±1	20±1	17±1	19±1	22±1	26±1	30±1	35±1	41 ^{+1.2} ₋₁	47 ^{+1.5} ₋₁	56 ^{+1.5} ₋₁	64 ^{+1.5} ₋₁	75 ^{+1.5} ₋₁	85 ⁺² ₋₁	110 ⁺² ₋₁

Table 2b Alignment tolerances of ES clutches

Type	Dimensions* Hole Ø [mm] H7	Clutch size EL	Max. torque [Nm]	Min. Overrun rotational speed Inner race [rpm]	Max. Overrun rotational speed Inner race [rpm]	Max. Pulling rotational speed [rpm]	Grease amount [cm ³]	Bearing type 2Z
RIZ..ELG2	30	5	750	700	9000	290	8	6009
	35	6	1100	670	8500	280	9	6010
	40	6	1600	630	7500	260	11	6011
	45	6	1824	610	6700	255	12	6012
	50	7	2800	560	6000	235	16	6014
	60	8	4700	510	5300	210	30	6016
	70	10	6100	470	4000	195	40	6018
	80C	11	9000	450	3000	190	45	6021
	80	11	11600	375	4000	155	45	6021
	90C	12	11500	420	2800	180	55	6024
	90	12	17400	350	3000	145	55	6024
	100C	14	19000	455	2500	200	100	6028
	100	14	32000	340	2400	140	100	6028
	130C	16	33750	415	2250	180	130	6032
130	16	46000	320	2400	130	130	6032	

*Special hole and reinforced spring design RIZ..ELG2 V
and VW as well as weak suspension RIZ..ELG2 upon request

Table 3 Specification for centrifugal lift-off one-way clutches with EL clutch and cover G2

The rotationally elastic clutch EL can compensate for the radial, axial and angular position deviations of the shafts to be connected. The transmission of the torques is done by way of the elastic transmission elements (see fig. 4 and 5).

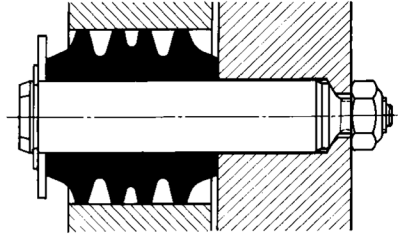

Fig. 2a Unstressed profile sleeve installed

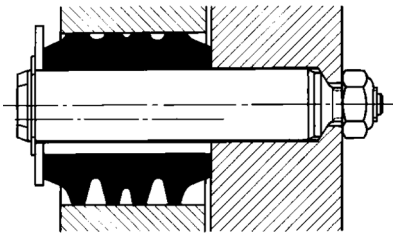
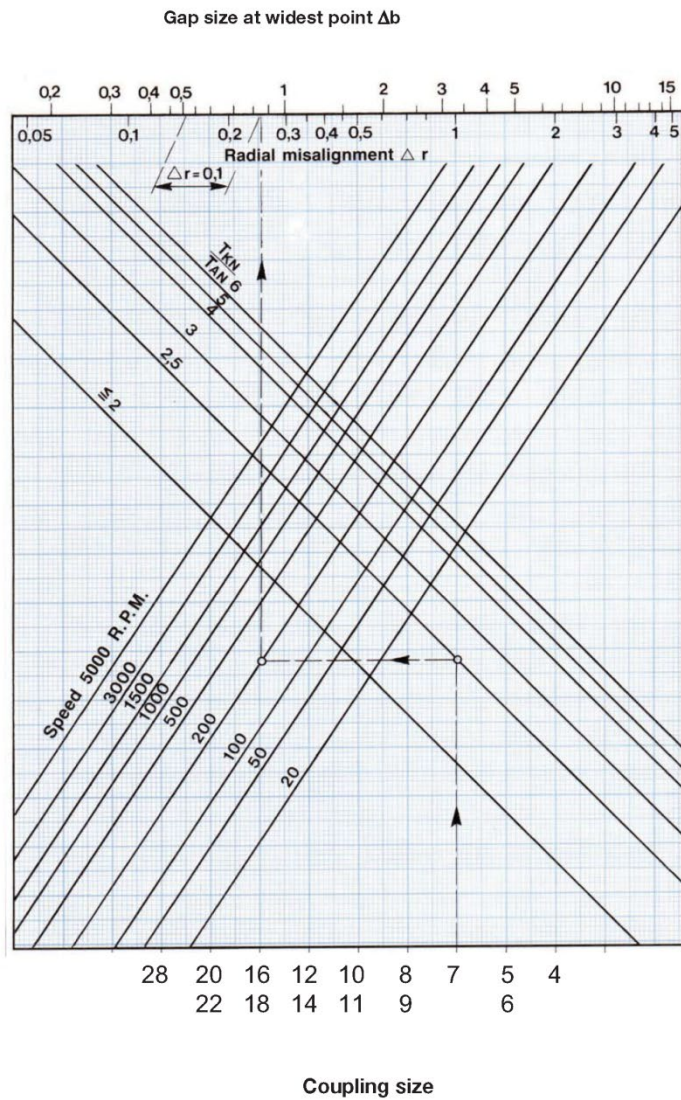
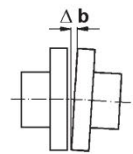
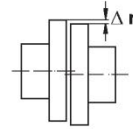

Fig. 2b Profile sleeve under load

Permissible Misalignment EL-Coupling



The permissible angular misalignment $\Delta \alpha$ is given as a measurable linear dimension Δb .



Design with intermediate disc



Design without intermediate disc



EL-Size	Permissible axial displacement	
	without [mm]	with intermediate disc [mm]
4	6	—
5	4	16
6	4	16
7	5	20
8	6	20
9	6	20
10	6	25
11	6	25
12	7	25
14	7	25
16	8	30
18	8	30
20	9	30
22	9	—
28	10	—

Example:

EL- Coupling size 214 with $T_{KN} / T_{AN} = 2,5$ and speed $n = 200$ R.P.M.

1. permissible radial misalignment $\Delta r = 0,25$ mm or

2. permissible angular misalignment $\Delta \alpha$ corresponding to $\Delta b = 0,85$ mm or

3. permissible radial and angular misalignment: e.g. if there is already a Δb of 0,5 then Δr can be 0,25 minus 0,15 = 0,1 mm.

Fig. 3 Permissible displacements of EL clutches

**NOTICE**

If the hole diameter is smaller than the maximum, the maximum torque to be transmitted depends on the fitting key connection.

- Limits for ambient temperature: -40°C to +50°C
- Max. operating temperature: 90°C (194°F)
- Machine shaft tolerance: d = h6 or j6
- Grease lubrication: Klübersynth BM 44-42 or approved greases as per Stieber product catalog / WN900

ISO - VG DIN 51519	Grease
ARAL	ARALUB HL2
BP	ENERGREASE LS2
CASTROL	SPHEEROL MP2
ESSO	UNIREX N2
FUCHS	RENOLIT LZR2
KLÜBER	POLYLUB WH2 KLÜBERSYNTH BM 44-42
MOBIL	POLYREX EM
SHELL	ALVANIARL2
TOTAL	MULTIS 2

Table 4 Recommended lubricants

**NOTICE**

Too much grease can impair the function of the one-way clutch.

3 Structure and function

3.1 Structure

Item 1	Outer race	Item 30	Locking ring
Item 2	Inner race	Item 31	EL clutch hub
Item 3	CAGE, CPL	Item 32	RIZ-EL flange
Pos. 4	Locking ring	Item 33	Threaded pin
Item 8	Cage	Item 35	Profile sleeve
Item 12	Cover G2	Item 36	Bolt
Item 13	Flange G1	Item 38	Nut
Item 14	Centering flange G7	Item 39	Washer
Item 15	Cover G5	Item 41	ES clutch hub
		Item 42	RIZ-ES flange
		Item 43	Threaded pin
		Item 45	Annular gear/saddle element
		Item 46	Retaining cap

Table 5 Parts list

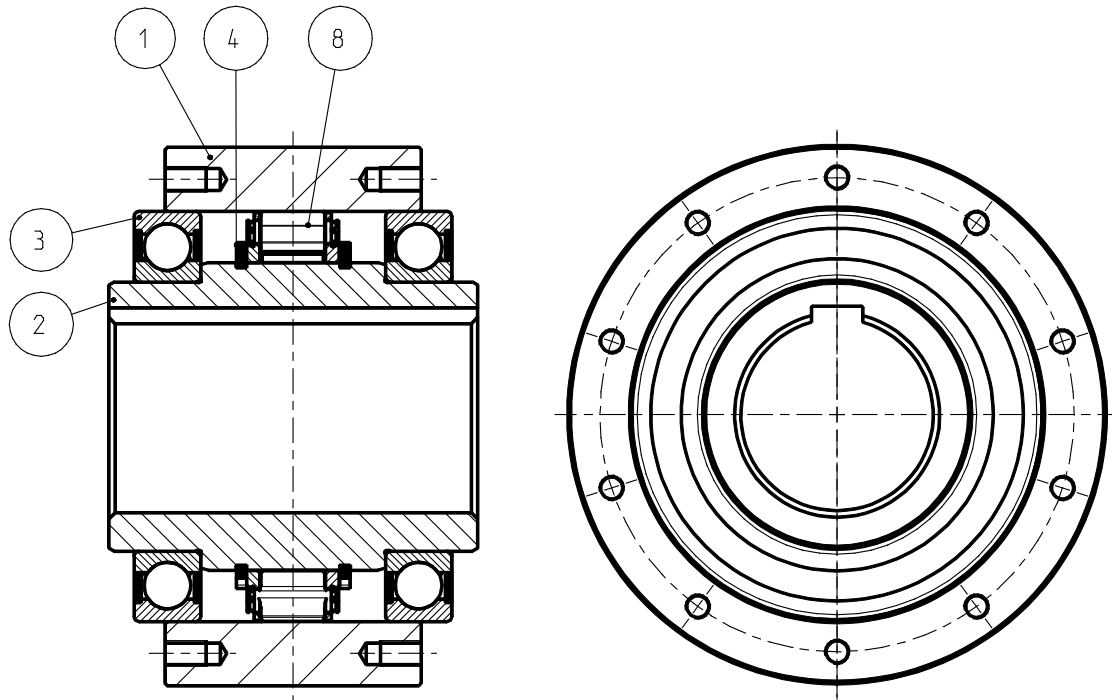

Fig. 4a Structure of RIZ

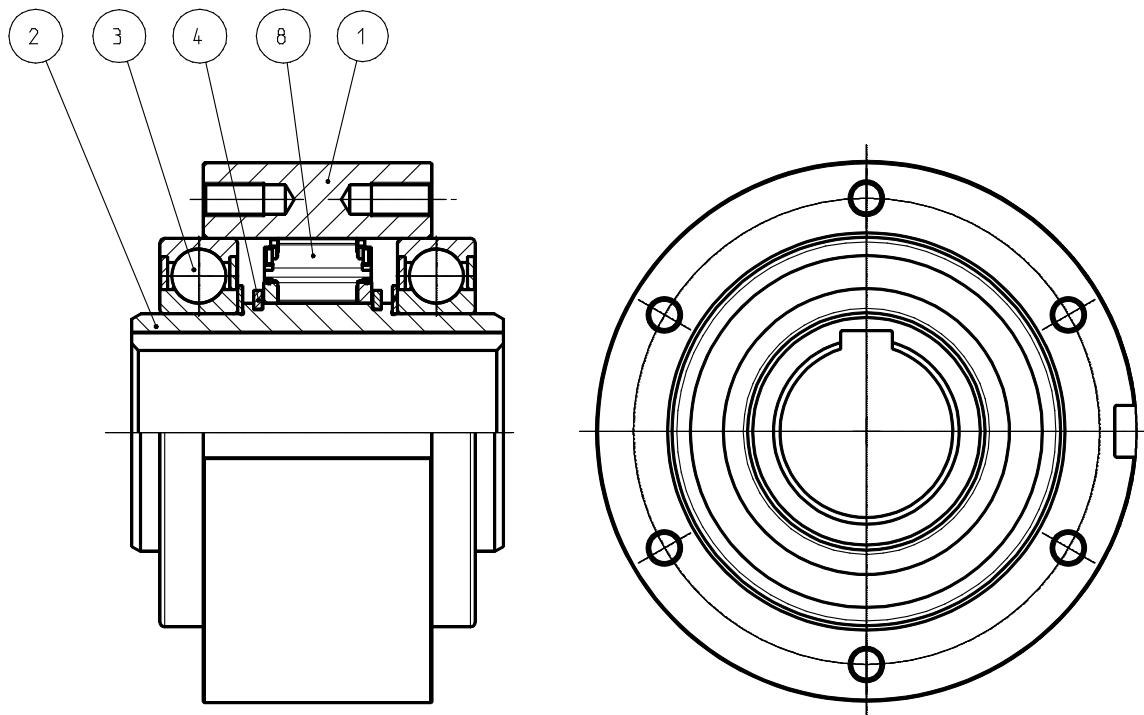

Fig. 4b Structure of RINZ

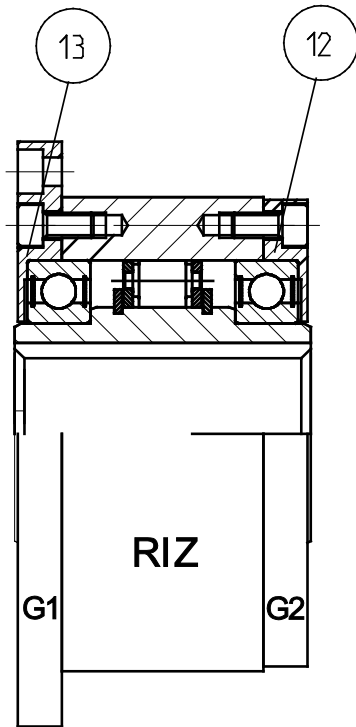

Fig. 4c Structure of RIZ...G1G2

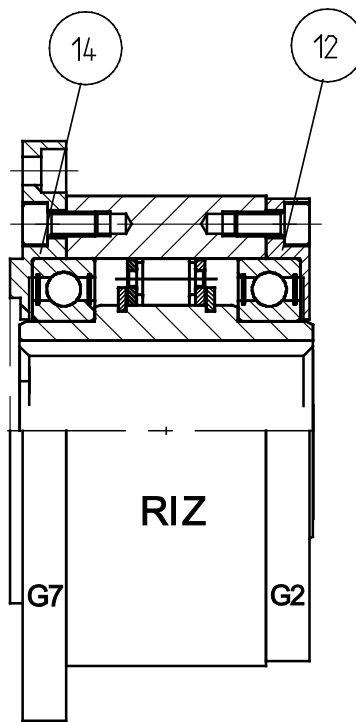

Fig. 4d Structure of RIZ..G7G2

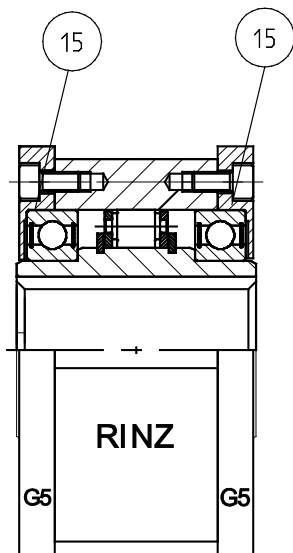
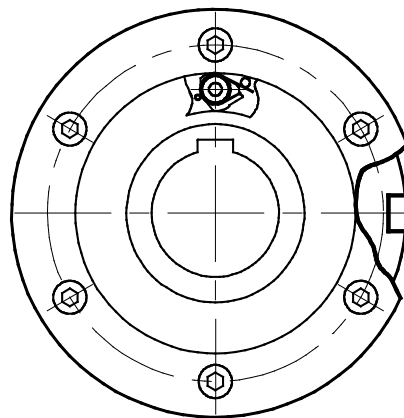

Fig. 4e Structure of RINZ..G5G5



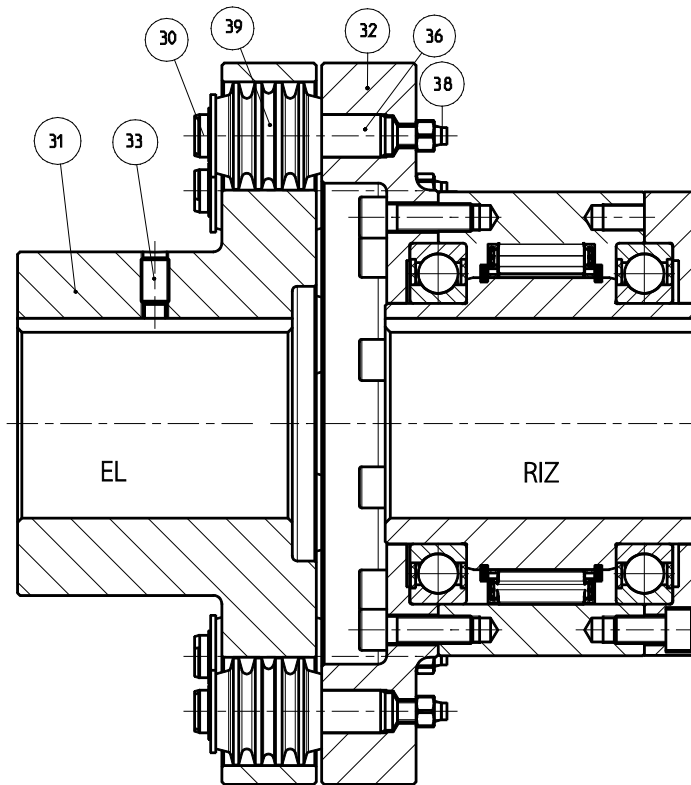

Fig. 4f Structure of RIZ...ELG2

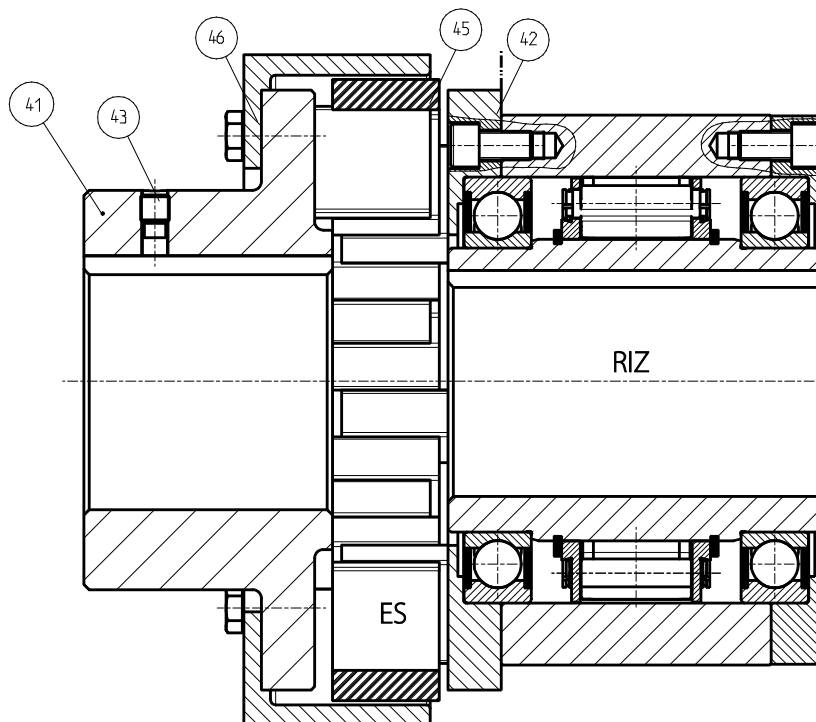

Fig. 4g Structure of RIZ...ESG2

3.2 Functional principle

When the torque is transmitted via the one-way clutch, the outer race and the inner race are coupled in a force-locked manner. For this purpose, sprags are used whose outer contours effect the force-locked coupling. The sprags are integrated into a cage and are pressed by springs into contact with the outer and inner race. The springs ensure rapid responding behavior of the one-way clutch at the start of torque transmission.

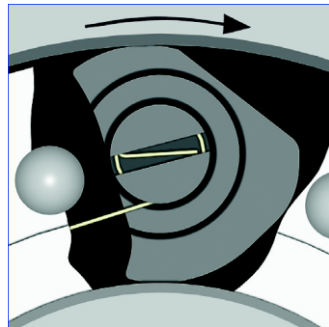

Fig. 5 Torque transmission

In overrun operation, above the minimum permissible overrun rotation speed, the centrifugal force, in connection with the geometry of the sprags, effects a recentering torque which turns the sprags against the spring force. A contactless position is brought about in this way so that wear-free operation of the one-way clutch can be achieved. The minimum permissible overrun rotation speed may only be lower for a short period during the start-up or shut-down stage of the machine as otherwise the damage to the contact partner caused by wear and tear may lead to the failure of the one-way clutch.

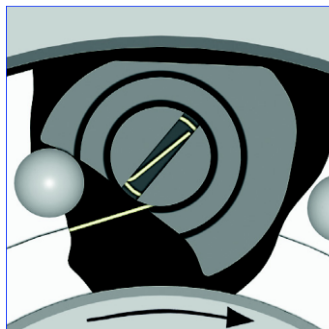

Fig. 6 Contactless position

4 Transport and packaging



NOTICE

The local provisions regarding the disposal of transport and packaging materials are to be observed.

One-way clutches of Type RIZ/ RINZ/ RIZ..G1G2/ RIZ..G2G7/ RINZ..G5G5/ RIZ..G2G3/ RIZ..G3G4/ RIZ..ESG2/ RIZ..ELG2 are packed in air cushion foils.

The one-way clutch is shipped in a box or on a pallet.

Transport damage to the packaging and/or the one-way clutch is to be reported to the respective transit company without delay.

The one-way clutch must be unpacked in a clean and dry environment.

5 Storage

5.1 Short-term storage

The one-way clutches RIZ/ RINZ/ RIZ..G1G2/ RIZ..G2G7/ RINZ..G5G5/ RIZ..G2G3/ RIZ..G3G4/ RIZ..ESG2/ RIZ..ELG2 are packed in VCI bubble wrap. The VCI bubble wrap is to be checked at regular intervals. The frequency of these intervals is dependent on the environmental conditions (temperature, moisture, salt content of the air, etc.) at the storage site.

The maximum storage period (short-term storage) is 6 months. Moreover, the one-way clutch must have long-term storage corrosion protection applied to it.

Store packages under the following conditions:

- Do not keep outdoors
- Keep dry and free from dust
- Do not expose to aggressive media
- Keep away from direct sunlight
- Avoid mechanical shocks and vibrations
- Storage temperature: -10 to +60°C
- Relative humidity: max. 95%, non-condensing

5.2 Long-term storage

For long-term storage, the one-way clutch must be shrink-wrapped with a desiccant and provided with a hygroscope. The corrosion protection must be checked after a period not exceeding one year or else depending on the environmental conditions (temperature, moisture, salt content of the air, etc.) at the storage site.

Store packages under the following conditions:

- Do not keep outdoors
- Keep dry and free from dust
- Do not expose to aggressive media
- Keep away from direct sunlight
- Avoid mechanical shocks and vibrations
- Storage temperature: -10 to +60°C
- Relative humidity: max. 95%, non-condensing

6 Installation

6.1 Checking the direction of rotation

	WARNING	<p>Danger of injury due to incorrect assembly! Incorrect assembly and maintenance can cause severe property damage and personal injury. Assembly, maintenance, and repair work may only be performed by personnel with the requisite training and expertise.</p>
---	----------------	---

	WARNING	<p>Danger of injury due to moving components! Rotating, driven components can cause severe injuries. Therefore, during operation:</p> <ul style="list-style-type: none"> ➤ It is strictly forbidden for persons to loiter in the hazard area or in its immediate vicinity. ➤ Do not disable, render unusable, or circumvent safety equipment and/or safety functions. <p>Prior to entering the hazard area:</p> <ul style="list-style-type: none"> ➤ Switch off the power supply and secure it against being switched on again. ➤ Wait for still moving components to come to a standstill.
---	----------------	---

	WARNING	<p>Danger of injury due to the one-way clutch falling down or tipping over! The weight of the one-way clutch can injure people and cause severe crushing. Therefore:</p> <ul style="list-style-type: none"> ➤ When lifting, use suitable lifting gear (slings, etc.) able to support the weight of the one-way clutch.
---	----------------	--

	WARNING	<p>Danger of injury for insufficiently qualified personnel! Improper handling can cause significant personal injury and property damage. Therefore:</p> <ul style="list-style-type: none"> ➤ Only ever have tasks performed by those persons to whom the tasks have been assigned.
---	----------------	--

Before installation, the direction of rotation of the one-way clutch must be checked.

6.2 Changing the direction of rotation

For RIZ / RINZ/ RINZ..G5G5 models, the direction of rotation is changed by reversing the one-way clutch.

For RIZ..G1G2/ RIZ..G2G7/ RIZ..G2G3/ RIZ..G3G4/ RIZ..ESG2/ RIZ..ELG2 models, the direction of rotation is changed by swapping the flange and cover or clutch and cover.

Procedural steps:

- Remove the cylinder screws from the covers and remove the covers.
- Place the flange and cover onto the opposite side and insert the cylinder screws with Loctite and tighten (see Table 6 Tightening torques).

Tightening torques [Nm]		
Freewheel size	Size	Strength class10.9
30 bis 35	M6	16,5
	M8	40,1
60 bis 80	M10	79
	M12	137
100 bis 130	M16	338
150	M20	661

Table 6 Tightening torques

- Check overrunning. The one-way clutch must be easy to turn in the overrun direction of rotation.

6.3 Lubrication

The one-way clutch base unit may only be lubricated in a lubricated state. It is lubricated with Klübersynth BM 44-42 in the factory.

6.4 Assembly

	WARNING	<p>Danger of injury due to incorrect assembly!</p> <p>Incorrect assembly and maintenance can cause severe property damage and personal injury.</p> <p>Assembly, maintenance, and repair work may only be performed by personnel with the requisite training and expertise.</p>
---	----------------	---

	WARNING	<p>Danger of injury due to moving components!</p> <p>Rotating, driven components can cause severe injuries. Therefore, during operation:</p> <ul style="list-style-type: none"> ➤ It is strictly forbidden for persons to loiter in the hazard area or in its immediate vicinity. ➤ Do not disable, render unusable, or circumvent safety equipment and/or safety functions. <p>Prior to entering the hazard area:</p> <ul style="list-style-type: none"> ➤ Switch off the power supply and secure it against being switched on again. ➤ Wait for still moving components to come to a standstill.
--	----------------	---

	WARNING	<p>Danger of injury due to falling components!</p> <p>Falling components can lead to serious injuries to persons.</p> <p>Secure the one-way clutch against falling down.</p>
---	----------------	---

	WARNING	<p>Danger of injury for insufficiently qualified personnel!</p> <p>Improper handling can cause significant personal injury and property damage. Therefore:</p> <ul style="list-style-type: none"> ➤ Only ever have tasks performed by those persons to whom the tasks have been assigned.
---	----------------	---

6.4.1 Installation of one-way clutch RIZ/ RINZ

Procedural steps:

- Insert the supporting fitting key according to DIN 6885 Sheet 1 over the entire length of the one-way clutch in the shaft. To transmit the torque on the outer race, the RINZ version is additionally fitted with a parallel keyway.

- Push one-way clutch onto the oiled machine shaft, attaching suitable lifting equipment if necessary.
- Tighten the machine element with the outer race. To do so, use fastening screws (e.g. as per standard DIN EN ISO 4762 and with screw quality 10.9) (see Table 6 Tightening torques in Section 6.2).
- Fasten the inner race axially.
- Check overrunning. After the assembly, the one-way clutch must be easy to turn in the overrun direction of rotation.

**NOTICE**

Use screw quality 10.9 only!

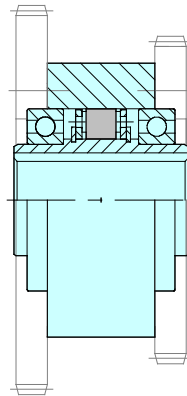

Fig. 7: Installation example RIZ/ RINZ

6.4.2 Installation of RIZ..G1G2 one-way clutch

Procedural steps:

- Insert the supporting fitting key according to DIN 6885 Sheet 1 over the entire length of the one-way clutch in the shaft .
- Push one-way clutch onto the oiled machine shaft, attaching suitable lifting equipment if necessary.
- Fasten flange G1 and the machine element with fastening screws (e.g. as per standard DIN EN ISO 4762 and with screw quality 10.9) (see Table 6 Tightening torques in Section 6.2).
- Fasten the inner race axially.
- Check overrunning. After the assembly, the one-way clutch must be easy to turn in the overrun direction of rotation.

**NOTICE**

Use screw quality 10.9 only!

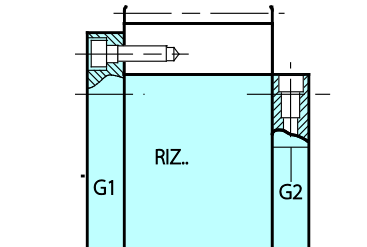

Fig. 8: RIZ..G1G2 installation example

6.4.3 Installation of RIZ..G2G7 one-way clutch

Procedural steps:

- Insert the supporting fitting key according to DIN 6885 Sheet 1 over the entire length of the one-way clutch in the shaft.
- Push one-way clutch onto the oiled machine shaft, attaching suitable lifting equipment if necessary.
- Fasten centering flange G7 and the machine element with fastening screws (e.g. as per standard DIN EN ISO 4762 and with screw quality 10.9) (see Table 6 Tightening torques in Section 6.2).
- Fasten the inner race axially.
- Check overrunning. After the assembly, the one-way clutch must be easy to turn in the overrun direction of rotation.

**NOTICE**

Use screw quality 10.9 only!

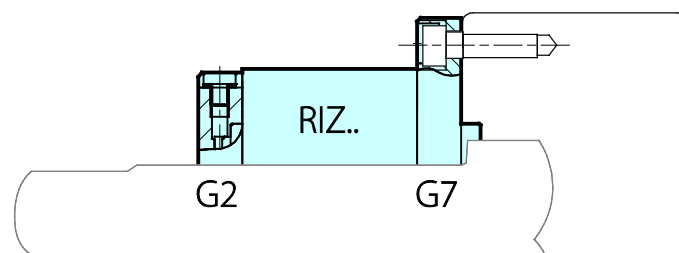

Fig. 9: RIZ..G2G7 installation example

6.4.4 Installation of RINZ..G5G5 one-way clutch

Procedural steps:

- Unfasten cover G5 from the outer race.
- Insert the fitting key.
- Slide the machine element onto the outer race and reinstall the removed cover again (see Table 6 Tightening torques in Section 6.2).
- Insert the supporting fitting key according to DIN 6885 Sheet 1 over the entire length of the one-way clutch in the shaft. Push one-way clutch onto the oiled machine shaft, attaching suitable lifting equipment if necessary. Fasten the inner race axially.
- Check overrunning. After the assembly, the one-way clutch must be easy to turn in the overrun direction of rotation.

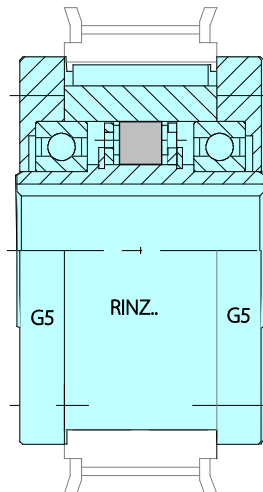

Fig. 10: Installation example RINZ..G5G5

6.4.5 Installation of RIZ..ELG2 one-way clutch

Procedural steps:

- Insert the supporting fitting key according to DIN 6885 Sheet 1 over the entire length of the EL clutch hub (31) in the shaft.
- Slide the clutch onto the shaft. Secure the clutch hub axially by tightening the threaded pin (33) using the fitting key.
- Insert the supporting fitting key according to DIN 6885 Sheet 1 over the entire length of the one-way clutch with RIZ-EL flange (32) in the shaft.

- Push the one-way clutch with RIZ-EL flange (32) onto the oiled machine shaft, attaching suitable lifting equipment if necessary.
- Fasten the inner race axially.
- Check overrunning. After the assembly, the one-way clutch with RIZ-EL flange (32) must be easy to turn in the overrun direction of rotation.
- The axial alignment of the clutch parts must be such that space "S" is not exceeded under any circumstances during operation (see Table 7 Installation of EL clutch).

**NOTICE**

Never grease or oil the profile sleeves as well as the sleeve holes in the part (31).

- With EL sizes 5 to 28, tap the bolts (36) slightly to drive them into the greased holes of the two clutch parts (32 and 31) if necessary.
With EL sizes 2 to 4, the bolts (36) are designed as grooved pins and must be firmly inserted into the clutch parts (32 and 31).

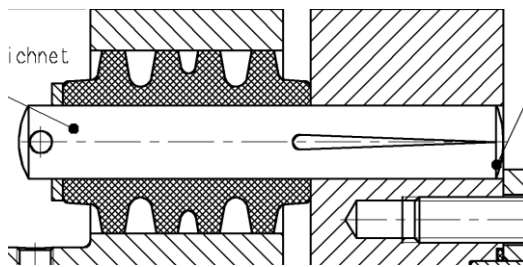

Fig. 11 Grooved pins with EL sizes 2 to 4

- Put on the profile sleeves (35), the washers (39), and the locking rings (30).
- The transfer bolts are tightened evenly after putting on the nuts (38) using a torque wrench (see Table 7 Installation of EL clutch) until their conical element makes contact in the shoulder of the hole.

**NOTICE**

Placing a wrench on the wrench flat of the bolt head prevents the transfer bolts from turning while the nuts are tightened.

Clutch size EL	Nominal installation dimension $S_{nom} = 0.5 S_{max}$ [mm]	Thread	Width across flats	Tightening torque in [Nm]
2	3	—	—	—
3	3	—	—	—
4	3	—	—	—
5	2	M8	Width 13	11
6	2	M8	Width 13	11
7	2.5	M8	Width 13	11
8	3	M10	Width 17	22
10	3	M12	Width 19	39
11	3	M12	Width 19	39
12	3.5	M16	Width 24	95
14	3.5	M16	Width 24	95
16	4	M20	SW30	184
18	4	M20	SW30	184
22	4.5	M24	SW36	315
28	5	M30	Width 46	635

Table 7 Installation of EL clutch

- After the installation of the transfer elements, gap " S_{nom} " must be checked again (see Table 7 Installation of EL clutch).

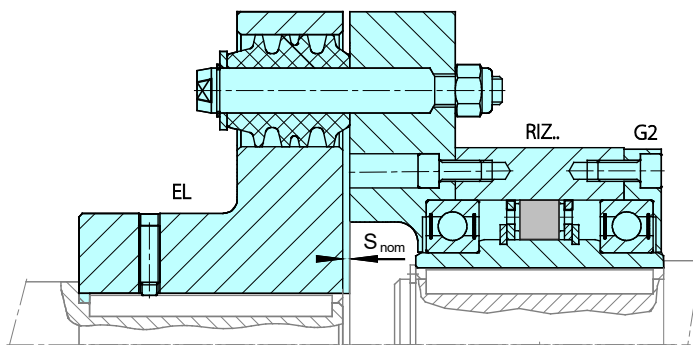

Fig. 11: RIZ..ELG2 installation example

6.4.6 Installation of RIZ..ESG2 one-way clutch

Procedural steps:

- Insert the supporting fitting key according to DIN 6885 Sheet 1 over the entire length of the ES clutch hub (41) in the shaft.
- Secure the clutch hub axially by tightening the threaded pin using the fitting key.
- Insert the supporting fitting key according to DIN 6885 Sheet 1 over the entire length of the one-way clutch with RIZ-ES flange (42) in the shaft
- Push the one-way clutch with RIZ-ES flange (42) onto the oiled machine shaft, attaching suitable lifting equipment if necessary.
- Fasten the inner race axially.
- Check overrunning. After the assembly, the one-way clutch with RIZ-ES flange (42) must be easy to turn in the overrun direction of rotation.
- The shafts must be placed into the bearings such that gap dimension "S₁" is maintained during operation (see Table 2b Alignment tolerances of ES clutches).

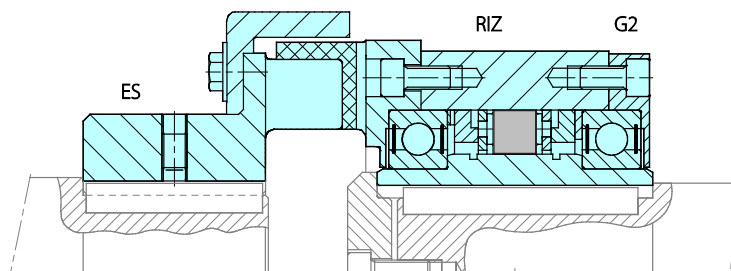





Fig. 12: RIZ..ESG2 installation example

7 Maintenance

	WARNING	<p>Danger of injury due to moving components! Rotating, driven components can cause severe injuries. Therefore, during operation:</p> <ul style="list-style-type: none"> ➤ It is strictly forbidden for persons to loiter in the hazard area or in its immediate vicinity. ➤ Do not disable, render unusable, or circumvent safety equipment and/or safety functions. <p>Prior to entering the hazard area:</p> <ul style="list-style-type: none"> ➤ Switch off the power supply and secure it against being switched on again. ➤ Wait for still moving components to come to a standstill.
---	----------------	--

	WARNING	Danger of injury due to incorrect assembly! Incorrect assembly and maintenance can cause severe property damage and personal injury. Assembly, maintenance, and repair work may only be performed by personnel with the requisite training and expertise.
---	----------------	--

	WARNING	Danger of injury due to falling components! Falling components can lead to serious injuries to persons. Secure the one-way clutch against falling down.
---	----------------	--

	WARNING	Danger of injury for insufficiently qualified personnel! Improper handling can cause significant personal injury and property damage. Therefore: <ul style="list-style-type: none"> ➤ Only ever have tasks performed by those persons to whom the tasks have been assigned.
---	----------------	--

	WARNING	Danger of scalding due to hot surfaces! There is a risk of burns and danger of scalding during operation due to hot surfaces. Therefore: <ul style="list-style-type: none"> ➤ Do not touch one-way clutches during operation!
---	----------------	--

The one-way clutches RIZ..G1G2/ RIZ..G2G7/ RINZ..G5G5/ RIZ..G2G3/ RIZ..G3G4/ RIZ..ESG2/ RIZ..ELG2 must be checked for damage and serviced after a maximum of **5 years of operation**.

7.1 Test criteria in case of need for maintenance

Procedural steps:

- Unfasten cover / flange combination (G1, G2, G3, G4, G5, G7) from the RIZ or RINZ base unit.
- Uninstall the grooved ball bearings (3) on both sides.
- Uninstall the outer race and the cage.

	NOTICE	New grooved ball bearings must be installed after all maintenance operations.
---	---------------	---

- Preclean the inner race (1), outer race (1) and cage (8) with a petroleum-based industrial cleaning agent and degrease with an acetone-based cleaning agent.
- Check for damage, wear and cracks (see test criteria):

- The outer race track must not exhibit any signs of damage / ruptures
- Increased diameter due to wear in the outer race track maximum 0.05 mm compared to unworn area
- Traces of deformation / indentations to the track diameters of the inner and outer race maximum 0.05 mm deep
- Completeness of all spring elements (2 per sprag)
- Spring elements free of damage / deformation
- Smooth rotation of the sprags from stop to stop
- maximum width of the wear facet on the sprag (see fig. 13)

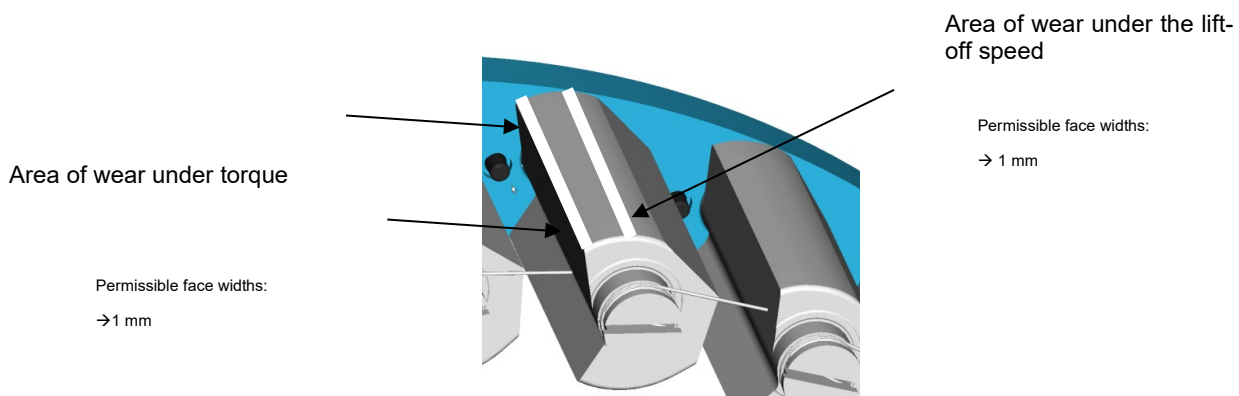

Fig. 13: Wear zones

- The one-way clutch can continue to be used only if all of the test criteria are met

7.2 Assembly in case of need for maintenance

Procedural steps:

- Place the cage (8) on the inner race (2) and fasten axially with locking rings (4).
- grease the outer race track with a layer thickness of roughly 1 mm:
 - Klübersynth BM 44-42 grease or approved greases as per Stieber product catalog / WN900 tab. 4
 - Grease amounts according to tab. 1 or tab. 2 or 3
- Secure the sprags of the one-way clutch in lift-off position with an assembly aid (O-ring / cable connector) (see figures 14 and 15).

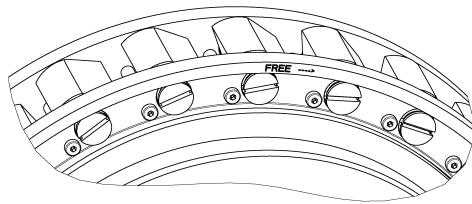

Fig. 14: Sprags in "service"

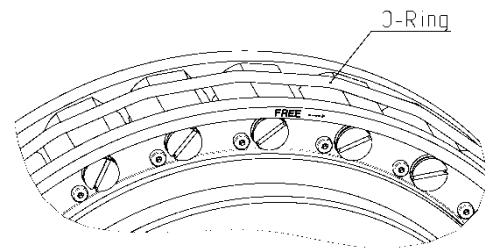

Fig. 15: Sprags "after lift-off"

- Insert the inner race (2) with cage (8) into the outer race (1) until half of the sprag is covered.
- Remove the assembly aid (O-ring / cable connector) and lower the outer race completely over the sprags.

**NOTICE**

The assembly aid (O-ring / cable connector) must be completely removed after assembly. Non-observance of this note can cause functional impairment and even failure.

- Apply the remaining grease in the free space between the cage and the bearing.
- Install grooved ball bearings.

**WARNING****Risk of damage to the bearings!**

Rolling bearing can be damaged during operation if installed incorrectly. Therefore:

- Only apply axial force via the inner race!

- Fasten cover / flange combination (G1, G2, G3, G4, G5, G7) from the RIZ or RINZ base unit. See table 6 Tightening torques for the correct tightening torque Table 8 Tightening torques.
- Fasten flanges G1 and G7 as well as the and the torque-supporting machine element with fastening screws (e.g. as per standard DIN EN ISO 4762) and with screw quality 10.9 (see Table 6 Tightening torques).

**NOTICE**

Screw quality 12.9 must not be used.

- Check overrunning.

7.3 Maintenance and replacement of the elastic elements of the EL clutch

The EL clutches are fitted with paraffin-coated profile sleeves (35), from which the paraffin emerges slowly in order to lubricate the bolts and plugs during operation. As a result, the sleeves become gray. This does not have any effect on the durability or the function.

No special maintenance of the EL clutch is required.

Replace the elastic elements as follows:

- With EL clutches sizes 2 to 4, the grooved locking pins and end disks must be removed before the profile sleeves are removed (see Fig. 11 Grooved pins with EL sizes 2 to 4).
- With EL clutches at or above size 5, the locking nuts (38) should first be released and the transfer bolts should be driven out slightly.
- Next, remove the locking rings (30) and end disks (39).
- Remove the profile sleeve (35).
- With EL sizes 5 to 28, tap the bolts (36) slightly to drive them into the greased holes of the two clutch parts (32 and 31).
With EL sizes 2 to 4, firmly insert the bolts (36) (grooved pins) into the coupling flange (32). This is why it must be possible to move one of the two shafts to be connected longitudinally for installation and removal.
- Put on the profile sleeves (35), the washers (39), and the locking rings (30).



NOTICE

To achieve a uniform transmission of force, the entire set of profile sleeves should always be replaced.

- The transfer bolts are tightened evenly after putting on the nuts (38) using a torque wrench (see Table 7 Installation of EL clutch) until their conical element makes contact in the shoulder of the hole.



NOTICE

Placing a wrench on the wrench flat of the bolt head prevents the transfer bolts from turning while the nuts are tightened.

7.4 Maintenance and replacement of the elastic elements of the ES clutch

No special maintenance of the ES clutch is required.



NOTICE

When mounting the elastic elements, ensure that the clutch halves are not mounted too close, in order to prevent the elastic elements from being exposed to lateral pressure and to ensure that the clutch remains flexible in the axial direction during use.

**NOTICE**

The clutch halves must not be mounted too far from each other; this ensures that the rubber blocks are capable of transmitting over the entire width between the coupling claws.

Replace the saddle element and the annular gears as follows:

- Loosen all screws from the retaining caps (46) and remove (from sizes 10 to 1600).

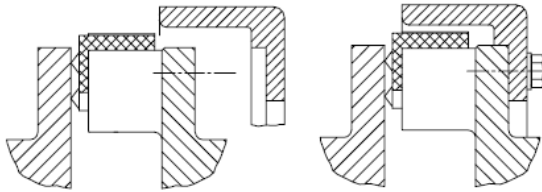

Fig. 16 Fastened retaining caps (from sizes 10 to 1,600)

- Remove the retaining cap. A threaded rod can be used as an aid to slide on the retaining cap.
- Remove the saddle element/annular gears.
- Install a new saddle element/annular gears (see Table 8 Elastic ES clutch elements).

Element type	Size	Number per clutch
ES annular gears	4 to 6.3 (without retaining caps)	1
ES annular gears	10 to 63 (with retaining caps)	1
ES saddle element	100 to 1600	6

Table 8 Elastic ES clutch elements

- Install retaining caps and tighten again with the tightening torque (Table 9 Tightening torques for ES retaining caps).

**NOTICE**

To help with the assembly when moving over the retaining cap while the saddle elements are inserted, the perimeter of the saddle elements can be coated with talcum or soft soap (no grease or oil).

Screw size	M6	M8	M10	M12	M16	M20	M24	M27	M30
Tightening torque [Nm]	10	25	49	86	210	410	710	1,050	1,450

Table 9 Tightening torques for ES retaining caps

8 Disassembly

	<p>WARNING</p>	<p>Danger of injury due to incorrect assembly! Incorrect assembly and maintenance can cause severe property damage and personal injury. Assembly, maintenance, and repair work may only be performed by personnel with the requisite training and expertise.</p>
---	-----------------------	---

	<p>WARNING</p>	<p>Danger of injury due to moving components! Rotating, driven components can cause severe injuries. Therefore, during operation:</p> <ul style="list-style-type: none"> ➤ It is strictly forbidden for persons to loiter in the hazard area or in its immediate vicinity. ➤ Do not disable, render unusable, or circumvent safety equipment and/or safety functions. <p>Prior to entering the hazard area:</p> <ul style="list-style-type: none"> ➤ Switch off the power supply and secure it against being switched on again. ➤ Wait for still moving components to come to a standstill.
---	-----------------------	---

	<p>WARNING</p>	<p>Danger of scalding due to hot surfaces! There is a risk of burns and danger of scalding during operation due to hot surfaces. Therefore:</p> <ul style="list-style-type: none"> ➤ Do not touch one-way clutches during operation!
---	-----------------------	---

	<p>WARNING</p>	<p>Danger of injury due to falling components! Falling components can lead to serious injuries to persons. Secure the one-way clutch against falling down.</p>
---	-----------------------	---

Procedural steps:

- Remove the axial fastening of the inner race (1).
- Loosen the fastening screws from the flange and from driven machine elements or supporting element.
- Pull the one-way clutch from the machine shaft using suitable lifting equipment, if required.
- With ES clutches, pull apart the respective shaft ends, loosen the threaded pin at the KMS clutch hub, and pull off the clutch hub from the shaft.

- With EL clutches sizes 2 to 4, the grooved locking pins and end disks must be removed before the profile sleeves are removed.
- With EL clutches at or above size 5, the locking nuts (38) should first be released and the transfer bolts should be driven out slightly.
- Next, remove the locking rings (30) and end disks (39).
- Remove the profile sleeve (35).
- Pull apart the respective shaft ends, loosen the threaded pin at the EL clutch hub, and pull off the clutch hub from the shaft.

9 Disposal



NOTICE

The local provisions regarding the disposal of metallic components and any lubricants present are to be observed.

The one-way clutch is comprised of metallic materials that are coated with grease or oil. Metallic materials are fully recyclable.

Lubricants and anticorrosive agents are to be disposed of separately.

The local disposal provisions are to be observed in this regard.

10 Faults

The manufacturer is to be contacted immediately should any faults arise.

STIEBER GMBH, D-69126 Heidelberg, Hatschekstr. 36, Germany
 Tel +49 (0) 6221 3047-0, Fax -31

11 Spare parts



WARNING

Danger of injury due to incorrect spare parts!

Incorrect or faulty spare parts can cause damage, malfunctions, or total failure as well as impair safety

. Therefore:

- Only use OEM parts from the manufacturer.

Procure spare parts only from authorized dealers or from the manufacturer directly.