

PR

Pressure Reducing Valves



Danfoss

Pressure Reducing Valves

Application Notes

Basic Operation: Pressure Reducing Valves

Pressure reducing valves are normally open pressure limiting devices. They limit one part of a circuit to a pre-determined setting, while allowing the inlet pressure to rise to full system pressure, if necessary. They come in two forms: direct acting or pilot operated. Both types have the option of an integrated pressure relief valve, which limits the regulated pressure in the case of external forces.

Direct Acting Spool Type with Relief

The direct acting pressure reducing valve is normally open from port 2 to 1, with port 3 connected to tank. As the pressure at the regulated port 1 increases to the valve setting, the spool moves back against the spring and restricts the flow between port 2 and 1 to maintain the regulated pressure setting. This limits the pressure in port 1, while pressure in port 2 will continue to rise. If an external force creates excessive pressure in the regulated port 1, the spool will move further back and open port 1 to port 3, working as a relief valve. These valves are ideal for limiting the pressure in brake or clutch actuators.

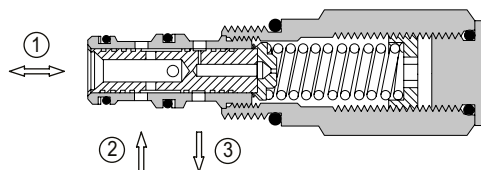
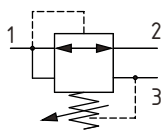

Pilot Operated Spool Type with Relief

The pilot operated pressure reducing valve is normally open from port 2 to 1, with port 3 connected to tank. As the pressure on the regulated port 1 increases to the valve setting, the pilot section will open and allow the main spool to shift and restrict flow from port 2 to 1. If the pressure in port 1 continues to rise, the main spool will move further back blocking the line between port 2 and 1. This limits the pressure in port 1, while pressure in port 2 will continue to rise. If an external force causes the pressure in port 1 to rise above the valve setting, the main spool will shift further and open port 1 to tank port 3, acting as a relief. These valves are ideal in applications where a constant force is required from an actuator with the possibility of external shock pressures such as suspension systems.

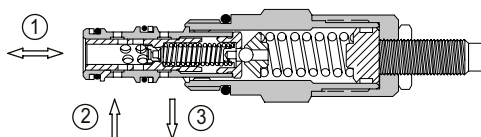
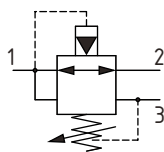

Direct Acting Spool Type without Relief

The direct acting pressure reducing valve without relief is normally open from port 2 to 1, with port 3 connected as a drain port only to tank. As the pressure at the regulated port 1 increases to the valve setting, the spool moves back against the spring and restricts the flow between port 2 and 1 to maintain the regulated pressure setting. This limits the pressure in port 1, while pressure in port 2 will continue to rise.

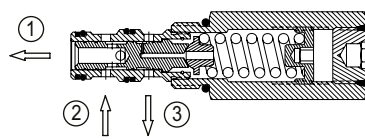
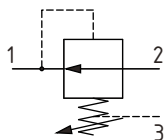

Pilot Operated Spool Type without Relief

The pilot operated pressure reducing valve without relief is normally open from port 2 to 1, with port 3 connected to tank. As the pressure on the regulated port 1 increases to the valve setting, the pilot section will open and allow the main spool to shift and restrict flow from port 2 to 1. If the pressure in port 1 continues to rise, the main spool will move further back blocking the line between port 2 and 1. This limits the pressure in port 1, while pressure in port 2 will continue to rise.

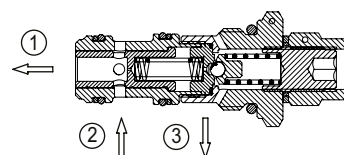
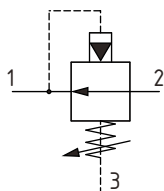

Pressure Reducing Valves

Application Notes

Pressure Reducing Valve Comparison

Characteristic \ Type	Direct Acting Reducing	Direct Acting Reducing/Relieving	Pilot Operated Reducing	Pilot Operated Reducing/Relieving
Dirt Tolerant	-	-	-	-
Fast Acting	+	+	-	-
Flow	-	-	+	+
Pressure	-	-	+	+
Stable	-	-	+	+
Relative Price [1 lowest]	1	1	2	2

Application Recommendations

- Pressure reducing valves are designed to limit pressure in a secondary circuit, allowing the rest of the circuit to work normally. If the inlet pressure falls below the setting of the reducing valve, then the regulated pressure will also fall.
- Direct acting valves are often used where a pressure limit is required for brake cylinders in accumulator circuits. The leakage from the system is limited to spool leakage, which reduces the re-charging frequency for the accumulators.
- Rapid removal of the inlet pressure on direct acting valves may not always be followed by the regulated pressure. If there is a dead head situation with a volume of oil under pressure, the valve will not open until leakage allows the pressure to fall enough for the valve to re-set.
- Pilot operated valves can be used to control clamping pressure, while a secondary operation is performed. If two pressures are required, you can place an on/off valve on the drain line. By blocking the drain port, the valve will remain open allowing full pressure to the actuator.
- If there is a check valve on the outlet (port 1) of the pressure reducing valve, the check valve will trap any temporary pressure spikes that in some cases may exceed the set pressure of the valve.
- For pressure differentials between the inlet pressure and the reduced pressure exceeding 210 bar (3000psi), please contact technical support.

Typical Applications

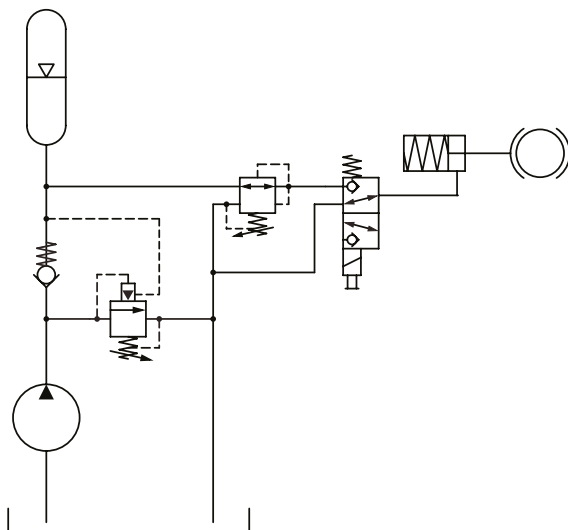

▲ Brake Circuit

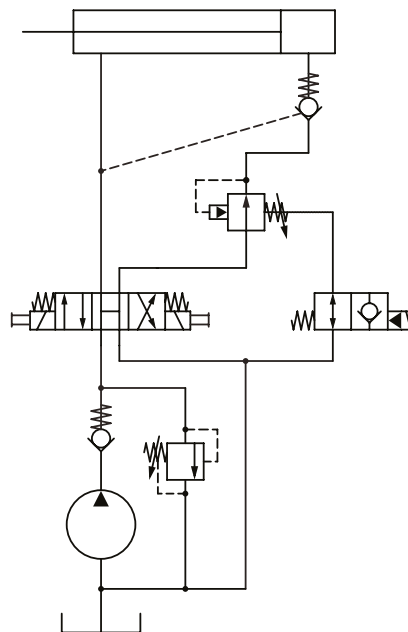

▲ Pressure Clamp Circuit

Pressure Reducing Valves

Quick Reference

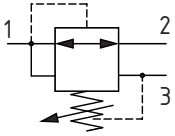
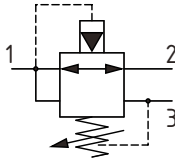
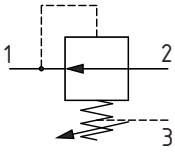
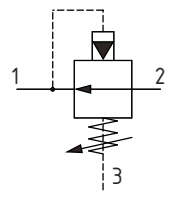
Pressure Reducing Valves	Model No.	Cavity	Description	Flow*	Pressure	Page
	PRV1-10	SDC10-3	Pressure Reducing Valve, Relieving, Direct Acting	15 l/min [4 US gpm]	210 bar [3000 psi]	5
	PRMP 064	SDC10-3	Pressure Reducing Valve, Relieving, Pilot Operated	40 l/min [11 US gpm]	315 bar [4600 psi]	6
	PRV12-10	SDC10-3	Pressure Reducing Valve, Relieving, Pilot Operated	45 l/min [12 US gpm]	350 bar [5000 psi]	7
	PRV12-12	C-12-3	Pressure Reducing Valve, Relieving, Pilot Operated	114 l/min [30 US gpm]	350 bar [5000 psi]	8
	PRV2-16	SDC16-3	Pressure Reducing Valve, Relieving, Pilot Operated	150 l/min [40 US gpm]	350 bar [5000 psi]	9
	PRR10-PVG	SDC10-3	Pressure Reducing Valve, Non-Relieving, Direct Acting	5 l/min [1.3 US gpm]	210 bar [3000 psi]	10
	PRC 06	NCS 06/3	Pressure Reducing Valve, Non-Relieving, Direct Acting	40 l/min [11 US gpm]	315 bar [4600 psi]	11
	CP230-2	SDC10-3	Pressure Reducing Valve, Non-Relieving, Direct Acting	40 l/min [11 US gpm]	210 bar [3000 psi]	12
	PPRC 06	NCS 06/3	Pressure Reducing Valve, Non-Relieving, Pilot Operated	40 l/min [11 US gpm]	315 bar [4600 psi]	13
	CP230-4	SDC10-3	Pressure Reducing Valve, Non-Relieving, Pilot Operated	40 l/min [11 US gpm]	350 bar [5000 psi]	14
	1PA100	A880	Pressure Reducing Valve, Non-Relieving, Pilot Operated	100 l/min [26 US gpm]	350 bar [5000 psi]	15
	1PA200	A16102	Pressure Reducing Valve, Non-Relieving, Pilot Operated	200 l/min [52 US gpm]	350 bar [5000 psi]	16

*Flow ratings are for reference only. Refer to individual product page for performance information.

Pressure Reducing Valves

PRV1-10

Pressure Reducing Valve, Relieving, Direct Acting

210 bar [3000 psi] • 15 l/min [4 US gpm]

DESCRIPTION AND OPERATION

This is a normally open, direct acting pressure reducing valve. Port 2 is open to port 1 until the setting is reached. at which time the valve throttles the outlet flow limiting the pressure at port 1. If the outlet pressure rises due to an external force, then the valve will open port 1 to port 3 acting as a relief valve. This valve is ideal for use in brake circuits where low leakage is important.

SCHEMATIC

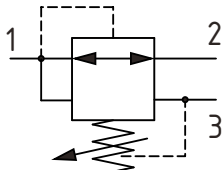

PERFORMANCE DATA

Rated pressure	210 bar [3000 psi]
Rated flow	15 l/min [4 US gpm]
Weight	0.24 kg [0.54 lbs]
Cavity	SDC10-3

MODEL CODE

PRV1 - 10 - V - C - 3B - 12 - 10

Seal Option

Code	Seal Kit
Omit - Buna -N	565804
V - Viton	889599

Adjustment Option

C - Tamper Resistant
F - Fixed
I - Internal
K - Knob
S - External

Housing

Code	Port Size	Housing Model Code	
		Aluminum standard duty	Aluminum heavy duty
0	No Housing		
3B	3/8" BSP	02-173358	-
6T	#6 SAE	566162	-
2G	1/4" BSP	-	876705
3G	3/8" BSP	-	876714
6H	#6 SAE	-	876704
8H	#8 SAE	-	876711

* Aluminum bodies are to be used for pressures less than 210 bar [3000 psi].

* Additional housings available

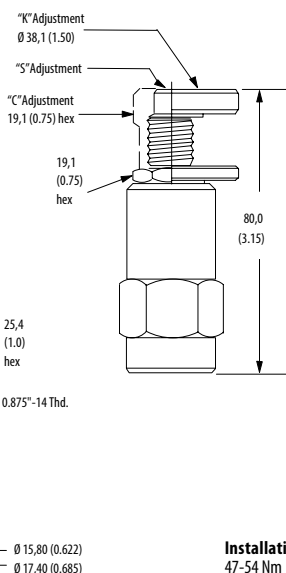

DIMENSIONS

mm [in]

Installation torque
47-54 Nm [35-40 ft. lbs]

PERFORMANCE CURVES

Pressure Override

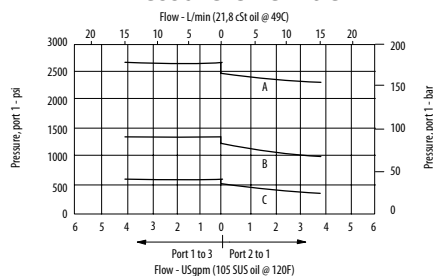

A - 24 spring • B - 12 spring • C - 6 spring

Pressure Setting

Code x100 - Pressure setting in psi
(50 psi increments within specified Pressure Setting)
XXX-Standard setting (see Pressure Setting for value)
Example:

Code	Bar	Psi
10	69	[1000]

Pressure Range

Code	Bar	Psi
2	3.5-14	[50-200]
Standard Setting	7	[100]
6	7-41	[100-600]
Standard Setting	21	[300]
12	14-83	[200-1200]
Standard Setting	41	[600]
24	28-165	[400-2400]
Standard Setting	83	[1200]

Pressure Reducing Valves

PRMP 064

Pressure Reducing, Relieving, Pilot Operated

315 bar [4600 psi] • 40 l/min [11 US gpm]

DESCRIPTION AND OPERATION

This is a normally open, pilot operated pressure reducing valve. Port 2 is open to port 1 until the setting is reached, at which time the valve throttles the outlet flow limiting the pressure. If the outlet pressure rises due to an external force, then the valve will open port 1 to port 3 acting as a relief valve. This valve is ideal for stable and precise control of a secondary pressure within a circuit.

SCHEMATIC

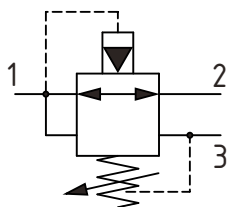

DIMENSIONS

mm [in]

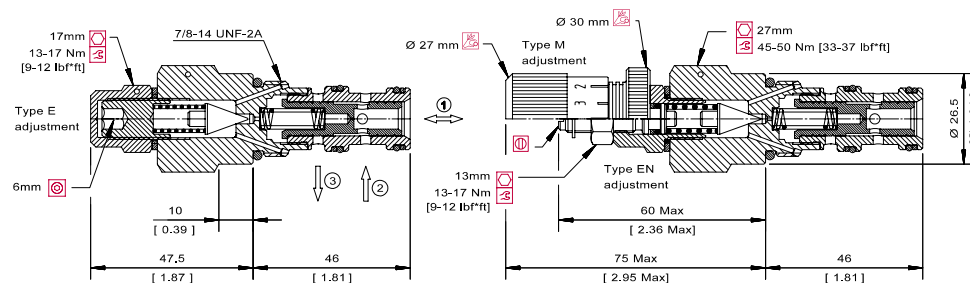

PERFORMANCE DATA

Rated pressure	315 bar [4600 psi]
Rated flow	40 l/min [11 US gpm]
Weight	0.21 kg [0.46 lb]
Cavity	SDC10-3

PERFORMANCE CURVES

Pressure Override

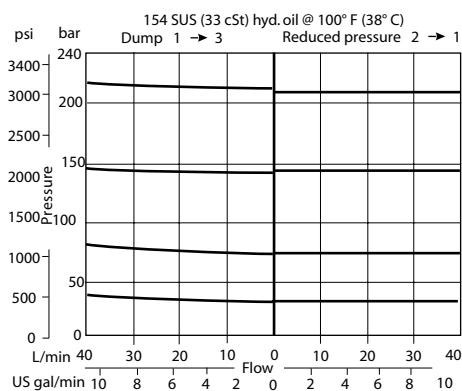

MODEL CODE

PRMP 064 - EN - 1 - 6S - V - 60

Adjustment Option

E - Internal
EN - External
M - Calibrated Knob

Pressure Range

Code	Bar	Psi
1	10-70	[145-1015]
Standard Setting		Not set
2	30-140	[435-2030]
Standard Setting		Not set
3	70-210	[1015-3000]
Standard Setting		Not set

Pressure Setting

Code - Pressure setting in bar (5 bar increments within specified Pressure Setting)

XXX - Standard setting (see Pressure Setting for value)
Example:

Code	Bar	Psi
60	60	[870]

Seal Option

Code	Seal Kit
V-Viton	354001019
Omit - Buna-N	354000919

Housing

Code	Ports	Housing Model Code
00	No Housing	No Housing
6S	#6 SAE. AL	CP10-3-6S
8S	#8 SAE. AL	CP10-3-8S
SE3B	3/8 BSP. AL	SDC10-3-SE-3B
SE4B	1/2 BSP. AL	SDC10-3-SE-4B

* Aluminum bodies are to be used for pressures less than 210 bar [3000 psi].

* Additional housings available

Pressure Reducing Valves

PRV12-10

Pressure Reducing Valve, Relieving, Pilot Operated

350 bar [5000 psi] • 45 l/min [12 US gpm]

DESCRIPTION AND OPERATION

This is a normally open, pilot operated pressure reducing valve. Port 2 is open to port 1 until the setting is reached, at which time the valve throttles the outlet flow limiting the pressure. If the outlet pressure rises due to an external force, then the valve will open port 1 to port 3 acting as a relief valve. This valve is ideal for stable and precise control of a secondary pressure within a circuit.

SCHEMATIC

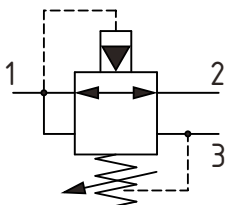

PERFORMANCE DATA

Rated pressure	350 bar [5000 psi]
Rated flow	45 l/min [12 US gpm]
Weight	0.24 kg [0.54 lbs]
Cavity	SDC10-3

MODEL CODE

PRV12 - 10 - V - C - S - 2G - 15 - 10

Seal Option

Code	Seal Kit
Omit-Buna-N	565804
V-Viton	889599

Adjustment Option

C - Tamper Resistant
F - Fixed
I - Internal
K - Knob
S - External

Housing Material

Omit - Aluminum/No housing
S - Steel

Housing

Code	Ports	Housing Model Code		
		Aluminum standard duty	Aluminum heavy duty	Steel heavy duty
0	No Housing			
3B	3/8" BSP	02-173358	-	-
2G	1/4" BSP	-	876705	02-175127
3G	3/8" BSP	-	876714	02-175128
6H	#6 SAE	-	876704	-
8H	#8 SAE	-	876711	-
6T	#6 SAE	566162	-	02-175124
8T	#8 SAE	-	-	02-175125

* Aluminum bodies are to be used for pressures less than 210 bar [3000 psi].
* Additional housings available

DIMENSIONS

mm [in]

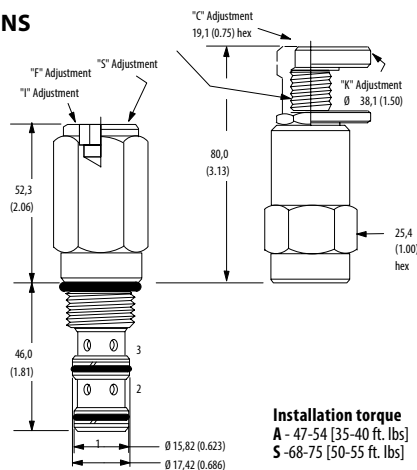

Installation torque
A - 47-54 [35-40 ft. lbs]
S - 68-75 [50-55 ft. lbs]

PERFORMANCE CURVES

Pressure Override

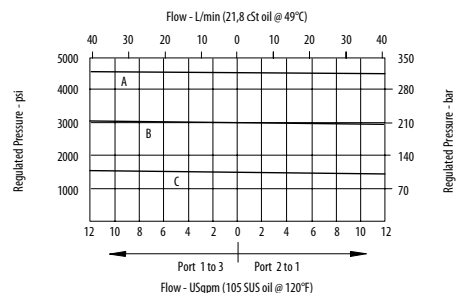

A - 50 spring • B - 30 spring • C - 15 spring

Pressure Setting

Code x100 - Pressure setting in psi
(50 psi increments within specified Pressure Setting)
XXX - Standard setting (see Pressure Setting for value)
Example:

Code	Bar	Psi
10	69	[1000]

Pressure Range

Code	Bar	Psi
15	8.5-103	[125-1500]
Standard Setting	52	[750]
30	17-210	[250-3000]
Standard Setting	103	[1500]
50	38-350	[550-5000]
Standard Setting	172	[2500]

Pressure Reducing Valves

PRV12-12

Pressure Reducing Valve, Relieving, Pilot Operated

350 bar [5000 psi] • 114 l/min [30 US gpm]

DESCRIPTION AND OPERATION

This is a normally open, pilot operated pressure reducing valve. Port 2 is open to port 1 until the setting is reached, at which time the valve throttles the outlet flow limiting the pressure. If the outlet pressure rises due to an external force, then the valve will open port 1 to port 3 acting as a relief valve. This valve is ideal for stable and precise control of a secondary pressure within a circuit.

SCHEMATIC

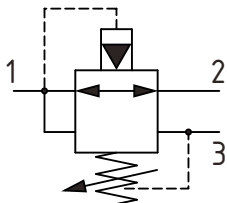

PERFORMANCE DATA

Rated pressure	350 bar [5000 psi]
Rated flow	114 l/min [30 US gpm]
Weight	0.4 kg [0.89 lbs]
Cavity	C-12-3

DIMENSIONS

mm [in]

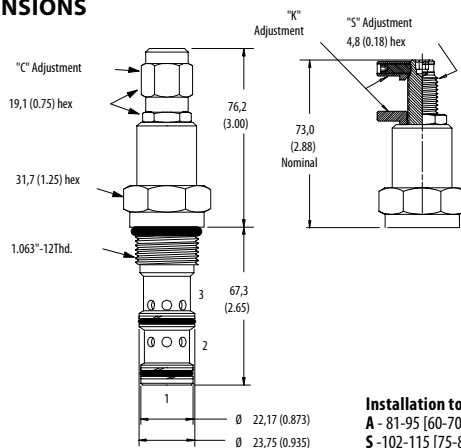

Installation torque
A - 81-95 [60-70 ft. lbs]
S - 102-115 [75-85 ft. lbs]

PERFORMANCE CURVES

Pressure Override

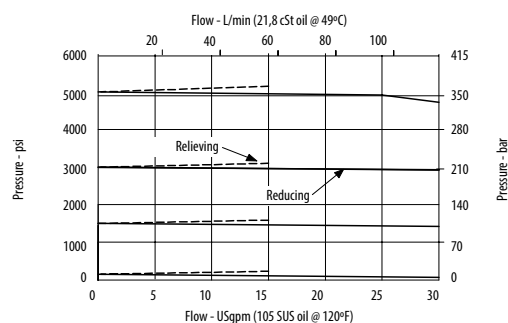

MODEL CODE

PRV12 - 12 - V - S - S - 10T - 15 - 10

Seal Option

Code	Seal Kit
Omit-Buna-N	02-165872
V-Viton	02-165886

Adjustment Option

S - External
 C - Tamper Resistant
 K - Knob

Housing Material

Omit - No housing
 A - Aluminum
 S - Steel

Housing

Code	Ports	Housing Model Code	
		Aluminum heavy duty	Steel heavy duty
0	No Housing		
10T	#10 SAE	02-160642	02-161070
12T	#12 SAE	02-160646	02-169816
4G	1/2" BSP	02-161817	02-169815
6G	3/4" BSP	02-161816	02-169814

* Aluminum bodies are to be used for pressures less than 210 bar [3000 psi].

* Additional housings available

Pressure Setting

Code x100 - Pressure setting in psi (50 psi increments within specified Pressure Range)
 XXX - Standard setting (see Pressure Range for value)
 Example:

Code	Bar	Psi
10	69	[1000]

Pressure Range

Code	Bar	Psi
15	10.3-103	[150-1500]
Standard Setting	52	[750]
30	17-210	[250-3000]
Standard Setting	103	[1500]
50	24-350	[350-5000]
Standard Setting	172	[2500]

Pressure Reducing Valves

PRV2-16

Pressure Reducing Valve, Relieving, Pilot Operated

350 bar [5000 psi] • 150 l/min [40 US gpm]

DESCRIPTION AND OPERATION

This is a normally open, pilot operated pressure reducing valve. Port 2 is open to port 1 until the setting is reached, at which time the valve throttles the outlet flow limiting the pressure. If the outlet pressure rises due to an external force, then the valve will open port 1 to port 3 acting as a relief valve. This valve is ideal for stable and precise control of a secondary pressure within a circuit.

SCHEMATIC

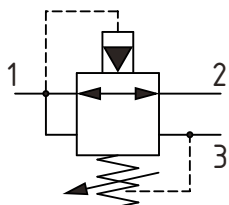

PERFORMANCE DATA

Rated pressure	350 bar [5000 psi]
Rated flow	150 l/min [40 US gpm]
Weight	0.40 kg [0.89 lbs]
Cavity	SDC16-3

MODEL CODE

PRV2 - 16 - V - C - S - 6B - 30 - 10

Seal Option

Code Seal Kit

Omit-Buna -N 565811

V-Viton 889610

Adjustment Option

C - Tamper Resistant

K - Knob

S - External

Housing Material

Omit- No housing

A - Aluminum

S - Steel

Housing

Code	Ports	Housing Model Code		
		Aluminum standard duty	Aluminum heavy duty	Steel heavy duty
0	No Housing			
6B	3/4" BSP	02-175465	-	-
4G	1/2" BSP	-	876720	02-175131
6G	3/4" BSP	-	876722	02-175132
10H	#10 SAE	-	876721	-
12H	#12 SAE	-	876723	-
10T	#10 SAE	-	-	02-175129
12T	#12 SAE	566152	-	02-175130

* Aluminum bodies are to be used for pressures less than 210 bar [3000 psi].

* Additional housings available

Pressure Setting

Code x100 - Pressure setting in psi (50 psi increments within specified Pressure Setting)

XXX-Standard setting (see Pressure Setting for value)

Example:

Code	Bar	Psi
10	69	[1000]
10.5	72.4	[1050]

Pressure Range

Code	Bar	Psi
30	34-210	[500-3000]
Standard Setting	103	[1500]
60	70-350	[1000-5000]
Standard Setting	210	[3000]

DIMENSIONS

mm [in]

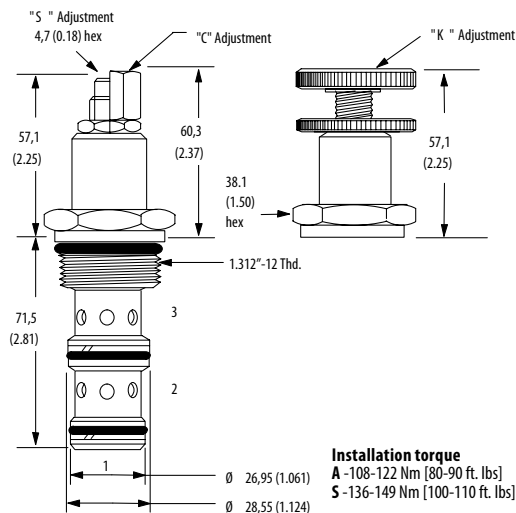

Installation torque

A -108-122 Nm [80-90 ft. lbs]

S -136-149 Nm [100-110 ft. lbs]

PERFORMANCE CURVES

Pressure Override

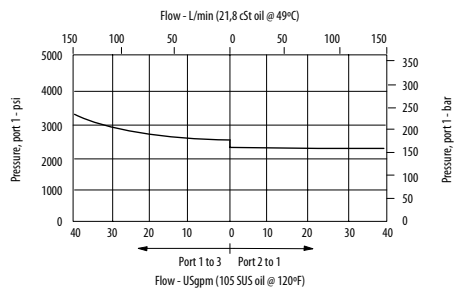

Pressure Reducing Valves

PRR10-PVG

Pressure Reducing Valve, Non-Relieving, Direct Acting

210 bar [3000 psi] • 5 l/min [1.3 US gpm]

DESCRIPTION AND OPERATION

This is a normally open, direct acting pressure reducing valve. Port 2 is open to port 1 until the setting is reached at which time the valve throttles the outlet flow limiting the pressure. Port 3 is a drain port only, as the valve does not contain a relief function. This valve, is ideal for stable and precise control of a secondary pressure within a circuit.

SCHEMATIC

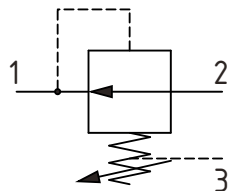

PERFORMANCE DATA

Rated pressure	210 bar [3000 psi]
Rated flow	5 l/min [1.3 US gpm]
Weight	0.23 kg [0.51 lb]
Cavity	SDC10-3

DIMENSIONS

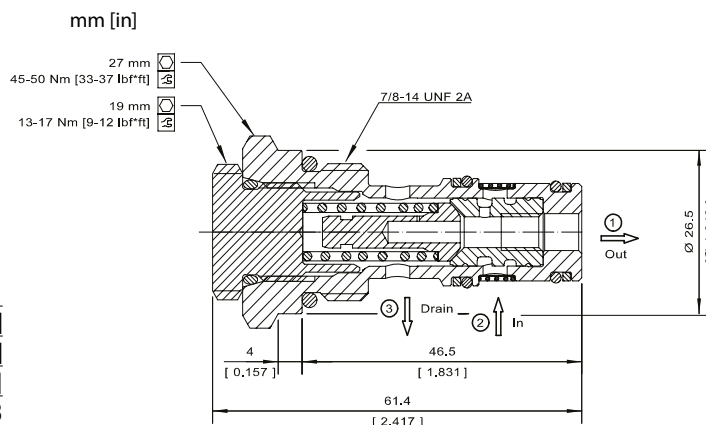

PERFORMANCE CURVES

Pressure Comparison from ports 2-1 at 1 l/min

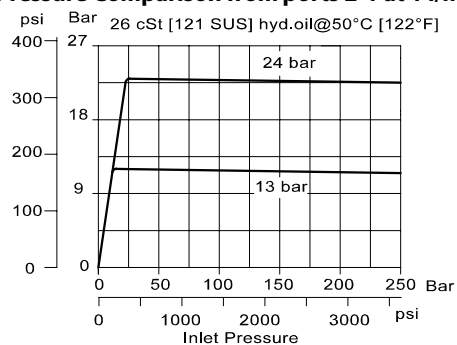

Reduced Pressure from ports 2-1

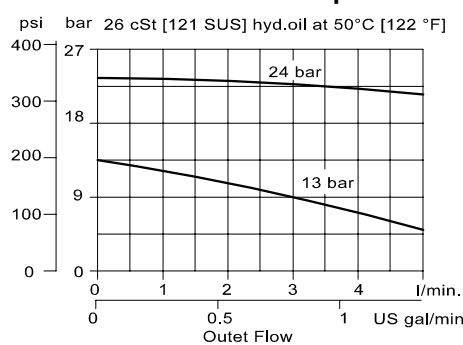

MODEL CODE

PRR10 - PVG - E-13 - B - F - 00

Pressure Setting

E-13 - 13 bar for Electrical [PVE]
H-24 - 24 bar for Hydraulic [PVH] or High Current [PVHC]

Seal Option

Code	Seal Kit
B - Buna-N	230000650
V - Viton	354001019

Housing

Code	Ports & Material	Housing Model Code
00	No housing	No Housing
6S	#6 SAE. AL	CP10-3-6S
8S	#8 SAE. AL	CP10-3-8S
SE3B	3/8 BSP. AL	SDC10-3-SE3B
SE4B	1/2 BSP. Steel	SDC10-3-SE4B

* Aluminum bodies are to be used for pressures less than 210 bar [3000 psi].
 * Additional housings available

Filter Option

Omit - Not required
F - 300 µm

Pressure Reducing Valves

PRC 06

Pressure Reducing Valve, Non-Relieving, Direct Acting

315 bar [4600 psi] • 40 l/min [11 US gpm]

DESCRIPTION AND OPERATION

This is a normally open, direct acting pressure reducing valve. Port 2 is open to port 1 until the setting is reached at which time the valve throttles the outlet flow limiting the pressure. Port 3 is a drain port only, as the valve does not contain a relief function. This valve, is ideal for stable and precise control of a secondary pressure within a circuit.

SCHEMATIC

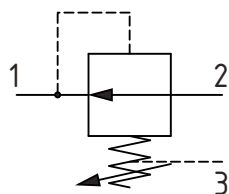

DIMENSIONS

mm [in]

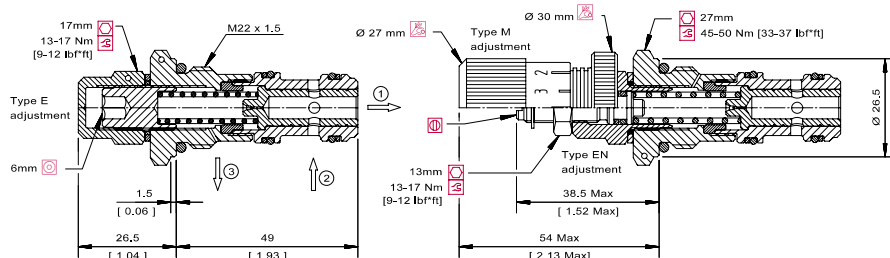

PERFORMANCE DATA

Rated pressure	315 bar [4600 psi]
Rated flow @ 7 bar [100 psi]	40 l/min [11 US gpm]
Weight	0.14 kg [0.31 lb]
Cavity	NCS 06/3

PERFORMANCE CURVES

Pressure Override

Reduced pressure

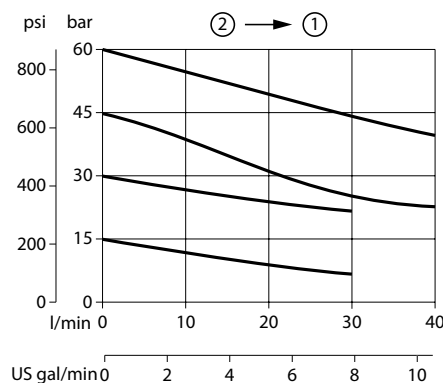

MODEL CODE

PRC 06 - EN - 2 - 00 - V - 60

Adjustment Option

E - Internal
EN - External
M - Calibrated Knob

Pressure Range

Code	Bar	Psi
5	1-10	[14.5-145]
Standard Setting	Not set	
1.5	10 - 25	[145-360]
Standard Setting	Not set	
2	25-80	[360-1150]
Standard Setting	Not set	

Pressure Setting

Code-Pressure setting in bar (5 bar increments within specified Pressure Range)
XXX-Standard setting (see Pressure Range for value)
Example:

Seal Option

Code	Seal Kit
Omit - Buna -N	230000070
Viton	230000110

Code	Bar	Psi
60	60	[870]

Housing

Code	Ports & Material	Housing Model Code
00	No Housing	No Housing
SE3/8	Al. 3/8 BSP	NCS06/3-SE-3/8
SE1/2	Al. 1/2 BSP	NCS06/3-SE-1/2
SE6S	Al. #6 SAE	NCS06/3-SE-6S
SE8S	Al. #8 SAE	NCS06/3-SE-8S

* Aluminum bodies are to be used for pressures less than 210 bar [3000 psi].

* Additional housings available

Pressure Reducing Valves

CP230-2

Pressure Reducing Valve, Non-Relieving, Direct Acting

210 bar [3000 psi] • 40 l/min [11 US gpm]

DESCRIPTION AND OPERATION

This is a normally open, direct acting pressure reducing valve. Port 2 is open to port 1 until the setting is reached at which time the valve throttles the outlet flow limiting the pressure. Port 3 is a drain port only, as the valve does not contain a relief function. This valve, is ideal for stable and precise control of a secondary pressure within a circuit.

SCHEMATIC

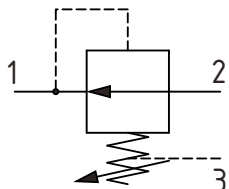

DIMENSIONS

mm [in]

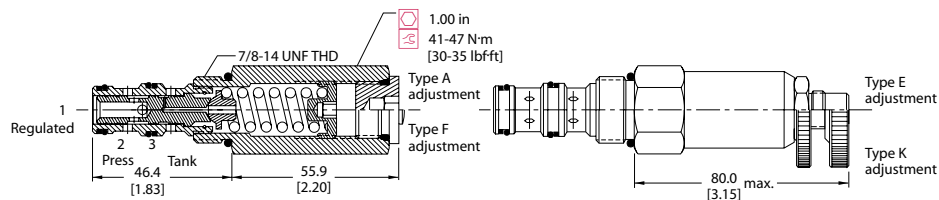

PERFORMANCE DATA

Rated pressure	210 bar [3000 psi]
Rated flow @ 7 bar [100 psi]	40 l/min [11 US gpm]
Weight	0.25 kg [0.56 lb]
Cavity	SDC10-3

PERFORMANCE CURVES

Pressure Override

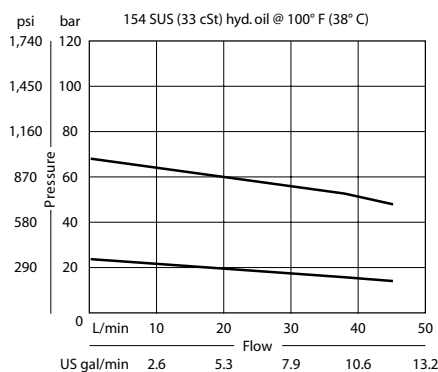

MODEL CODE

CP230 - 2 - B - 6S - A - C - 075

Seal Option

Code	Seal Kit
B - Buna -N	120027
V - Viton	120028

Housing

Code	Ports & Material	Housing Model Code
00	No Housing	No Housing
SE3B	Al. 3/8 BSP	SDC10-3-SE-3B
SE4B	Al. 1/2 BSP	SDC10-3-SE-4B
6S	Al. #6 SAE	CP10-3-6S
8S	Al. #8 SAE	CP10-3-8S

* Aluminum bodies are to be used for pressures less than 210 bar [3000 psi].

* Additional housings available

Adjustment Option

A - Internal
E - External
F - Tamper resistant
K - Knob

Pressure Setting

Code x10 - Pressure setting in psi (10 psi increments within specified Pressure Range)
XXX - Standard setting (see Pressure Range for value)

Example:

Code	Bar	Psi
075	52	[750]

Pressure Range

Code	Bar	[psi]
A	4-28	[50-400]
Standard Setting	17	[250]
B	5-55	[75-800]
Standard Setting	28	[400]
C	7-97	[100-1400]
Standard Setting	69	[1000]
D	34-166	[500-2400]
Standard Setting	103	[1500]

Pressure Reducing Valves

PPRC 06

Pressure Reducing, Non-Relieving, Pilot Operated

315 bar [4600 psi] • 40 l/min [11 US gpm]

DESCRIPTION AND OPERATION

This is a normally open, pilot operated pressure reducing valve. Port 2 is open to port 1 until the setting is reached at which time the valve throttles the outlet flow limiting the pressure. Port 3 is a drain port only, as the valve does not contain a relief function. This valve, is ideal for stable and precise control of a secondary pressure within a circuit.

SCHEMATIC

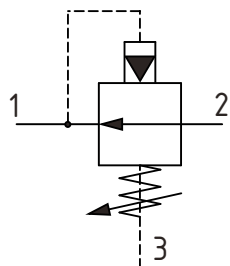

DIMENSIONS

mm [in]

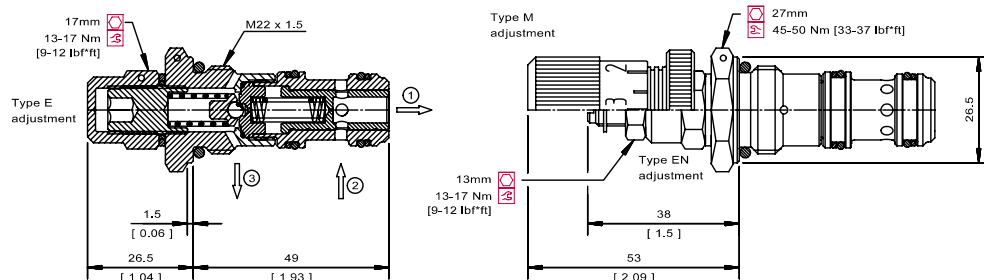

PERFORMANCE DATA

Rated pressure	315 bar [4600 psi]
Rated flow @ 7 bar [100 psi]	40 l/min [11 US gpm]
Weight	0.14 kg [0.31 lb]
Cavity	NCS 06/3

PERFORMANCE CURVES

Pressure Override

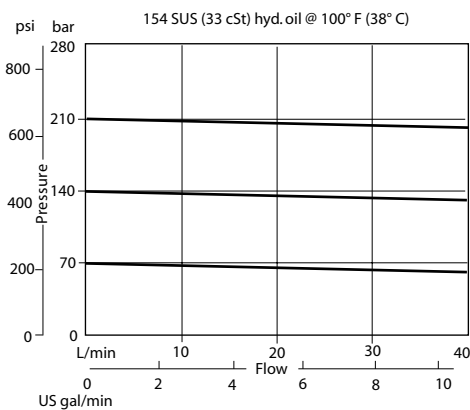

MODEL CODE

PPRC 06 - EN - 1 - 00 - V - 60

Adjustment Option

E - Internal
EN - External
M - Calibrated Knob

Pressure Range

Code	Bar	Psi
1	10-70	[145-1015]
Standard Setting		Not set
2	30-140	[435-2030]
Standard Setting		Not set
3	70-210	[1015-3000]
Standard Setting		Not set

Pressure Setting

Code - Pressure setting in bar (5 bar increments within specified Pressure Range)
XXX - Standard setting (see Pressure Range for value)

Example:

Code	Bar	Psi
60	60	[870]

Seal Option

Code	Seal Kit
V - Viton	230000110
Omit - Buna - N	230000070

Housing

Code	Ports & Material	Housing Model Code
00	No Housing	No Housing
SE3/8	Al. 3/8 BSP	NCS06/3-SE-3/8
SE1/2	Al. 1/2 BSP	NCS06/3-SE-1/2
SE6S	Al. #6 SAE	NCS06/3-SE-6S
SE8S	Al. #8 SAE	NCS06/3-SE-8S

* Aluminum bodies are to be used for pressures less than 210 bar [3000 psi].

* Additional housings available

Pressure Reducing Valves

CP230-4

Pressure Reducing, Non-Relieving, Pilot Operated

350 bar [5000 psi] • 40 l/min [11 US gpm]

DESCRIPTION AND OPERATION

This is a normally open, pilot operated pressure reducing valve. Port 2 is open to port 1 until the setting is reached at which time the valve throttles the outlet flow limiting the pressure. Port 3 is a drain port only, as the valve does not contain a relief function. This valve, is ideal for stable and precise control of a secondary pressure within a circuit.

SCHEMATIC

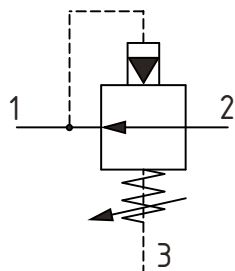

DIMENSIONS

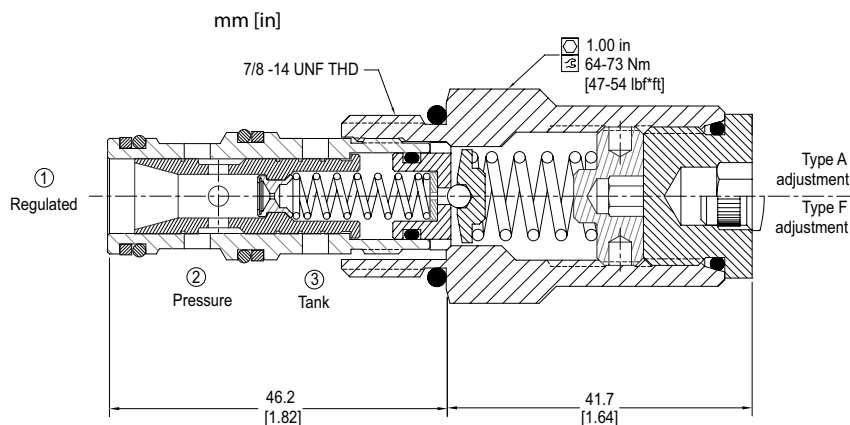

PERFORMANCE DATA

Rated pressure	350 bar [5000 psi]
Rated flow @ 7 bar [100 psi]	40 l/min [11 US gpm]
Weight	0.20 kg [0.43 lb]
Cavity	SDC10-3

PERFORMANCE CURVES

Pressure Override

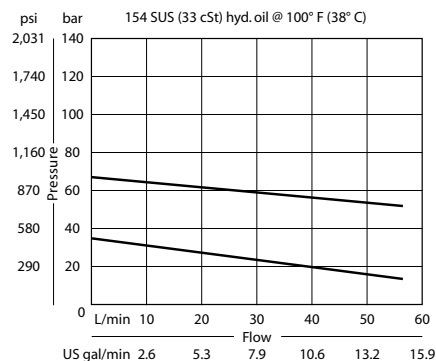

MODEL CODE

CP230 - 4 - B - 6S - A - C - 150

Seal Option

Code	Seal Kit
B - Buna -N	120027
V-Viton	120028

Housing

Code	Ports & Material	Housing Model Code
00	No Housing	No Housing
SE3B	Al. 3/8 BSP	SDC10-3-SE-3B
SE4B	Al. 1/2 BSP	SDC10-3-SE-4B
6S	Al. #6 SAE	CP10-3-6S
8S	Al. #8 SAE	CP10-3-6S

* Aluminum bodies are to be used for pressures less than 210 bar [3000 psi].

* Additional housings available

Adjustment Option

A - Internal
E - External
F - Tamper Resistant
K - Knob

Pressure Setting

Code x10 - Pressure setting in psi
(10 psi increments within specified Pressure Range)
XXX-Standard setting (see Pressure Range for value)
Example:

Code	Bar	Psi
150	103	[1500]

Pressure Setting

Code	Bar	Psi
A	14-55	[200-800]
Standard Setting	28	[400]
B	21-103	[300-1500]
Standard Setting	69	[1000]
C	28-210	[400-3000]
Standard Setting	103	[1500]
D	28-350	[400-5000]
Standard Setting	103	[1500]

Pressure Reducing Valves

1PA100

Pressure Reducing Valve, Non-Relieving, Pilot Operated

350 bar [5000 psi] • 100 l/min [26 US gpm]

DESCRIPTION AND OPERATION

This is a normally open, pilot operated pressure reducing valve. Port 2 is open to port 1 until the setting is reached at which time the valve throttles the outlet flow limiting the pressure. Port 3 is a drain port only, as the valve does not contain a relief function. This valve, is ideal for stable and precise control of a secondary pressure within a circuit.

SCHEMATIC

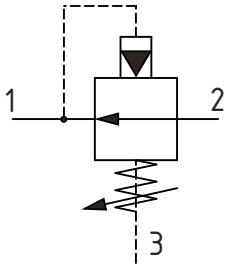

PERFORMANCE DATA

Rated pressure	350 bar [5000 psi]
Rated flow	100 l/min [26 US gpm]
Weight	0.17 kg [0.37 lbs]
Cavity	A880

MODEL CODE

1PA100 - P - 4W - 35 - S - 377 - 60

Basic Code

1PA100- No housing
1PA150- Cartridge and housing

Adjustment Option

P - External
R - Knob
G - Tamper Resistant

Housing

Code	Port Size	Housing Model Code	
		Aluminum single	Steel single
Omit	No Housing		
4W	1/2" BSP, 1/4" BSP Drain Port	B4821	B4527
6W	3/4" BSP, 1/4" BSP Drain Port	B5466	B4403
8T	1/2" SAE, 1/4" SAE Drain Port	B6584	
12T	3/4" SAE, 1/4" SAE Drain Port	B7883	B11379

* Aluminum bodies are to be used for pressures less than 210 bar [3000 psi].

* Additional housings available

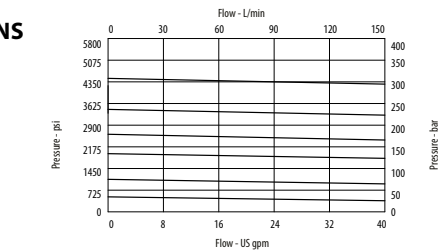

DIMENSIONS

mm [in]

Installation torque
60 Nm [44 ft. lbs]

PERFORMANCE CURVES

Pressure Override

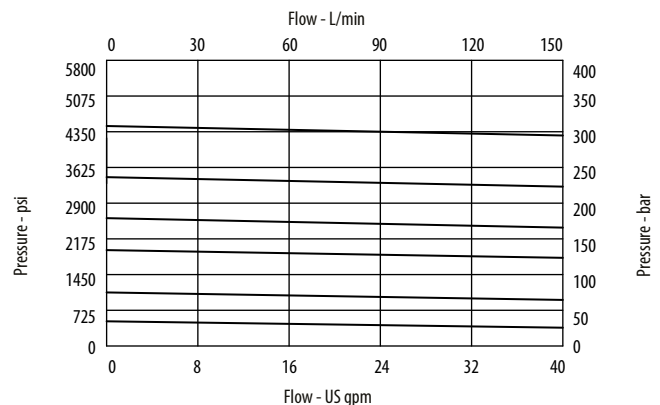

Pressure Setting
Code-Pressure setting in bar (5 bar increments within specified Pressure Range)
XXX-Standard setting (see Pressure Range for value)
Example:

Code	Bar	Psi
60	60	[870]

Code	Seal Kit
S-Buna-N	SK177
SV-Viton®	SK177V

Pressure Range

Code	Bar	Psi
7	10-70	[145-1015]
Standard Setting	20	[290]
20	15-210	[220-3000]
Standard Setting	100	[1450]
35	30-350	[435-5000]
Standard Setting	280	[4060]

Pressure setting made at zero flow (dead head)

Pressure Reducing Valves

1PA200

Pressure Reducing Valve, Non-Relieving, Pilot Operated

350 bar [5000 psi] • 200 l/min [52 US gpm]

DESCRIPTION AND OPERATION

This is a normally open, pilot operated pressure reducing valve. Port 2 is open to port 1 until the setting is reached at which time the valve throttles the outlet flow limiting the pressure. Port 3 is a drain port only, as the valve does not contain a relief function. This valve, is ideal for stable and precise control of a secondary pressure within a circuit.

SCHEMATIC

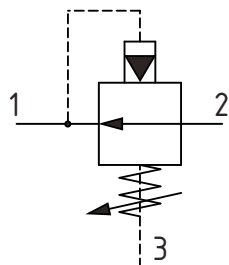

PERFORMANCE DATA

Rated pressure	350 bar [5000 psi]
Rated flow	200 l/min [52 US gpm]
Weight	0.72 kg [1.59 lbs]
Cavity	A16102

MODEL CODE

1PA250 - P - 8W - 35 - S - 377 - 60

Basic Code

1PA200 - No housing
1PA250 - Cartridge and Housing

Adjustment Option

P - External
R - Knob
G - Tamper Resistant

Housing

Code	Port Size	Housing Model Code	
		Aluminum single	Steel single
Omit	No Housing		
8W	1" BSP 1/4" BSP Drain Port	B3496	B3497
12T	3/4" SAE 1/4" BSP Drain Port	B10786	
16T	1" SAE 1/4" SAE Drain Port	B6807	B11555

* Aluminum bodies are to be used for pressures less than 210 bar [3000 psi].

* Additional housings available

Pressure Setting

Code - Pressure setting in bar (5 bar increments within specified Pressure Range)
XXX - Standard setting (see Pressure Range for value)
Example:

Code	Bar	Psi
60	60	[870]

Housing Material

Omit - Aluminum/No housing
377 - Steel

Seal Option

Code	Seal Kit
S - Buna-N	SK173
SV - Viton®	SK173V

Pressure Range

Code	Bar	Psi
20	10-210	[145-3000]
Standard Setting	100	[1450]
35	30-350	[435-5000]
Standard Setting	280	[4060]

Pressure setting made at zero flow (dead head)

DIMENSIONS

mm [in]

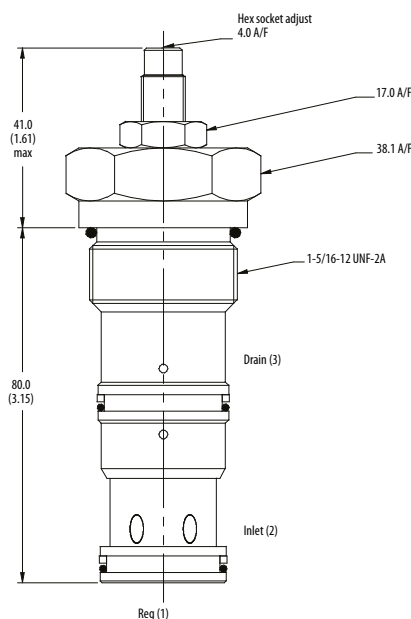

Installation torque
100 Nm [76 ft. lbs]

PERFORMANCE CURVES

Pressure Override

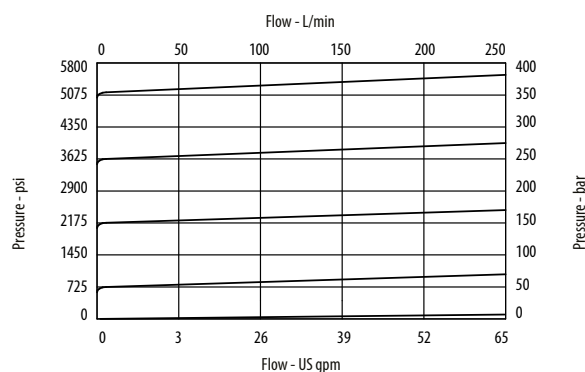

Danfoss