

Technical Information

GearMe

Aluminum Group 0 and Group 1 Pump

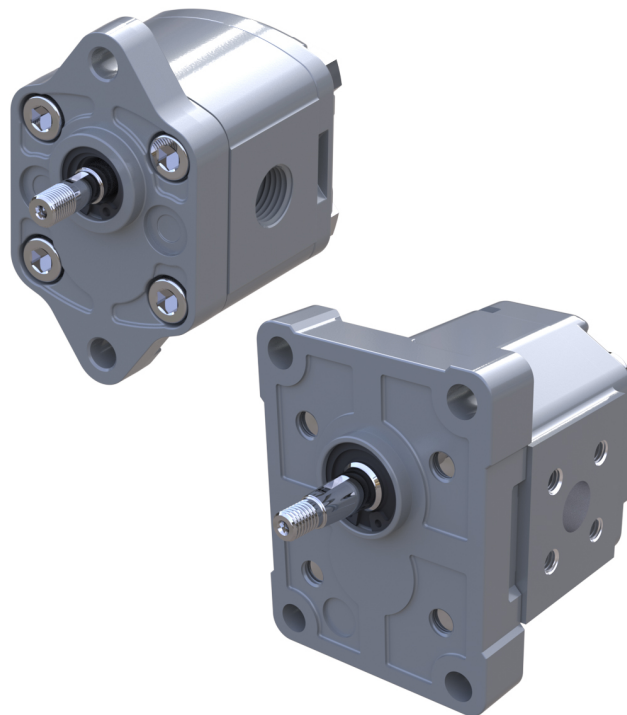

Revision history*Table of revisions*

Date	Changed	Rev
February 2023	Fixed typo	0203
January 2023	Renamed product	0202
April 2021	Content correction throughout document	0201
October 2019	First edition	0101

Contents

General Information

Overview.....	5
Features and benefits.....	6

Group 0

Design.....	7
Features.....	7
Product Code.....	8
Model code.....	8
A Family.....	8
B Displacement.....	8
C Rotation.....	9
D Project version.....	9
E Mounting flange.....	9
F Drive gear.....	9
G Rear cover.....	9
H Inlet size; I Outlet size.....	9
J Ports positions & Special body.....	10
K Seals.....	10
L Screws.....	10
M Set valve.....	10
N Type mark.....	10
O Mark position.....	10
Dimensions.....	11
TFPONN-01FA.....	11

Group 1

Pump design.....	12
SNP1NN.....	12
SKP1NN.....	13
SKP1IN AND SNP1IN.....	13
Pump displacements.....	14

General Information

Technical data.....	15
---------------------	----

Product Code

Model code.....	17
A Family.....	17
B Displacement.....	17
C Rotation.....	17
D Project version.....	17
E Mounting flange.....	18
F Drive gear.....	18
G Rear cover.....	18
H Inlet size; I Outlet size.....	18
J Ports positions & Special body.....	19
K Seals.....	19
L Screws.....	20
M Set valve.....	20
N Type mark.....	20
O Mark position.....	20

Determination of Nominal Pump Sizes

Determination of nominal pump sizes.....	21
--	----

System Requirements

Pressure.....	22
Speed.....	22
Hydraulic fluids.....	23
Temperature and viscosity.....	23
Filtration.....	24

Contents

Filters.....	24
Selecting a filter.....	24
Reservoir.....	24
Line sizing.....	25
Pump drive.....	25
Pump drive data form.....	26
Pump Life.....	27
Sound levels.....	27

Pump Performance

Pump performance graphs.....	28
------------------------------	----

Product Options

Flange, shaft and port configurations.....	31
Shaft options.....	31
Inlet/Outlet port configurations.....	32
Ports.....	33
SNP1IN.....	34
Variant codes for ordering integral relief valves.....	35
Integral relief valve schematic.....	36

Dimensions

SNP1NN - 01BA and 01DA.....	37
SKP1NN – 02BB and 02FA.....	38
SNP1NN – 03CA.....	39
SKP1NN – 06GA and 06SA.....	40

General Information**Overview**

The Danfoss Group 0 and Group 1 is a range of peak performance fixed-displacement gear pumps. Constructed of a high strength extruded aluminum body with aluminum cover and flange, all pumps are pressure-balanced for exceptional efficiency. The flexibility of the range, combined with high efficiency and low noise, makes the pumps in this series ideal for a wide range of applications, including: turf care, aerial lifts, material handling, and power packs.

TFP0NN 01FA



SNP1NN 01BA

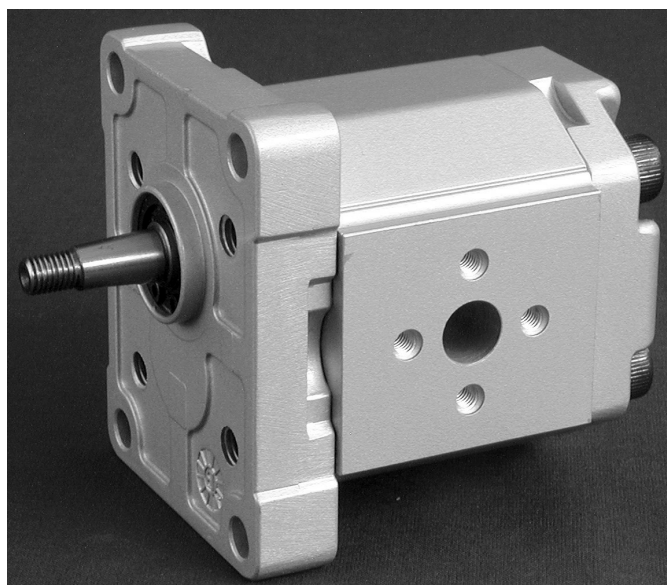

General Information

SKP1NN 06SA

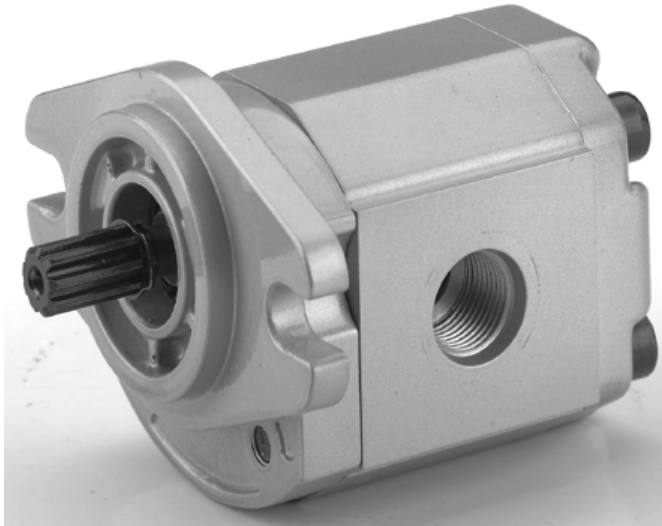

SNP1NN 03CA



Features and benefits

Gear pump attributes:

- Up to 16 displacements from 0,25 to 12 cm³/rev [from 0.015 to 0.732 in³/rev]
- Continuous pressure rating up to 250 bar [3625 psi]
- Speeds up to 4000 min⁻¹ (rpm)
- SAE, ISO, and DIN mounting flanges and shafts
- Compact, lightweight, quiet operation
- Group 1 units are available as unidirectional and bi-directional motors, also with integral relief valve
- You can combine groups 1, 2 and 3 to make multi-stage pump

Group 0

TFP0NN pumps provide flexibility, numerous displacements, features, and shaft/port options. The TFP0NN series has earned an excellent reputation for rugged, dependable performance at continuous pressures and speeds.

TFP0NN 01FA



TFP0NN pumps are available in five displacements from 0.25 to 1.27 cm³/rev [0.015 to 0.075 in³/rev]. Complete information can be found by referring to the specific sections in this technical manual.

Design

Constructed of high strength aluminum, the TFP0NN rotation is either clockwise or counterclockwise.

Features

Special features of Group 0 pumps include:

- Wide range of displacements
- Parallel shaft ends
- Standard mounting flange (European, 2-bolt)
- European port options

Group 0

Technical data – Group 0 gear pumps

		Frame size				
		,25	,45	,57	,76	1,3
Displacement	cm ³ /rev [in ³ /rev]	0.25 [0.015]	0.45 [0.027]	0.57 [0.034]	0.76 [0.045]	1.27 [0.075]
Peak pressure	bar [psi]	200 [2900]	200 [2900]	200 [2900]	200 [2900]	200 [2900]
Rated pressure		180 [2600]	180 [2600]	180 [2600]	180 [2600]	180 [2600]
Minimum pressure at maximum speed		103 [1500]	103 [1500]	103 [1500]	103 [1500]	103 [1500]
Minimum speed at 103 bar [1500 psi]	min ⁻¹ (rpm)	500	500	500	500	500
Maximum speed		8000	8000	8000	7000	5000
Weight	kg [lb]	0.40 [0.88]	0.45 [1.00]	0.46 [1.01]	0.47 [1.03]	0.48 [1.06]
Moment of inertia of rotating components	x 10 ⁻⁶ kg·m ² [x 10 ⁻⁶ lb·ft ²]	0.425 [10.09]	0.544 [12.91]	0.621 [14.74]	0.737 [17.49]	1.049 [24.89]
Theoretical flow at maximum speed	l/min [US gal/min]	2.00 [0.53]	3.60 [0.95]	4.56 [1.20]	5.32 [1.41]	6.35 [1.68]

1 kg·m² = 23.68 lb·ft²

[For applications requiring parameters beyond those listed above, contact Danfoss.](#)

Product Code

Model code

A Family

A	B	C	D	E	F	G	H	I	J	K	L	M	N	O
• • • • • • /														

TFP0NN	Std gear pump
TFR0NN	Reversible pump

B Displacement

A	B	C	D	E	F	G	H	I	J	K	L	M	N	O
/ • • •														

,25	Displacement 0,25cc
,45	Displacement 0,45cc
,57	Displacement 0,57cc
,76	Displacement 0,76cc
1,3	Displacement 1,3cc

Group 0

C Rotation

A				B				C	D	E	F	G	H	I	J	K	L	M				N	O	
								•										/						

L	Left rotation
R	Right rotation
B	Reversible pump

D Project version

A				B				C	D	E	F	G	H	I	J	K	L	M				N	O	
								•										/						

N	Std gear version
----------	------------------

E Mounting flange

A				B				C	D	E	F	G	H	I	J	K	L	M				N	O	
									•	•								/						

Code	Description (Type of flange • Type of drive gear • Preferred ports for configuration)
01	European 2-bolt flange

F Drive gear

A				B				C	D	E	F	G	H	I	J	K	L	M				N	O	
											•	•						/						

CA	Tang drive 5xØ7
FA	Parallel shaft 7,0 mm [0.276 in]

G Rear cover

A				B				C	D	E	F	G	H	I	J	K	L	M				N	O	
												•	•					/						

P1	Standard cover for pump
R1	Standard cover for reversible pump

H Inlet size; I Outlet size

A				B				C	D	E	F	G	H	I	J	K	L	M				N	O
													•	•	•	•					/		

Group 0

D1	M10x1- Threaded metric port	
D3	M14x1,5- Threaded metric port	
F2	1/4 GAS - Threaded BSP port	

J Ports positions & Special body

A					B	C	D	E	F	G	H	I	J	K	L	M			N	O
					/									•	•		/			

NN	Std position from catalog
-----------	---------------------------

K Seals

A					B	C	D	E	F	G	H	I	J	K	L	M			N	O
					/									•		/				

N	Standard Buna seal
----------	--------------------

L Screws

A					B	C	D	E	F	G	H	I	J	K	L	M			N	O
					/										•	/				

N	Std screws
----------	------------

M Set valve

A					B	C	D	E	F	G	H	I	J	K	L	M			N	O
					/											/	•	•	•	

NNN	No valve
------------	----------

N Type mark

A					B	C	D	E	F	G	H	I	J	K	L	M			N	O
					/											/			•	

N	Standard Danfoss Marking
----------	--------------------------

A	Standard Danfoss Marking+Customer Code
----------	--

O Mark position

A					B	C	D	E	F	G	H	I	J	K	L	M			N	O
					/											/			•	

Group 0

N	Std Marking position (on top)
A	Special Marking position on the bottom

Dimensions
TFP0NN-01FA

Available 01FA configuration only.

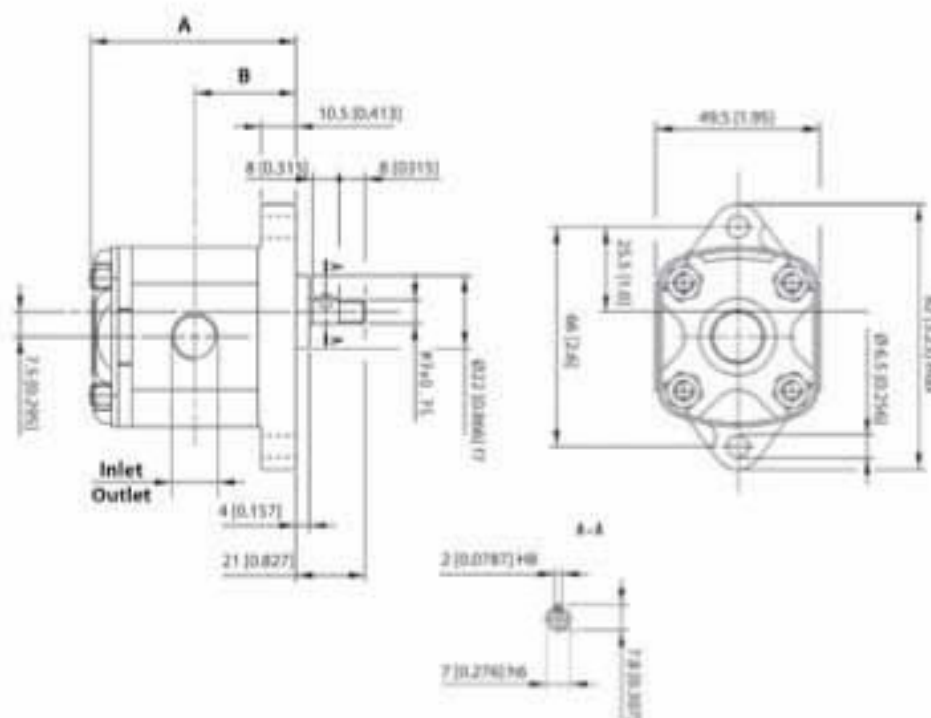
TFP0NN dimensions

Frame size		,25	,45	,57	,76	1,3
Dimension	A	53.5 [2.10]	55.0 [2.16]	56.0 [2.20]	61.5 [2.42]	61.5 [2.42]
	B	26.5 [1.04]	27.3 [1.07]	27.8 [1.09]	30.5 [1.20]	30.5 [1.20]
Inlet/Outlet		M10 x 1				

Model code examples and maximum shaft torque

Flange/drive gear	Model code example	Maximum shaft torque
01FA	TFP0NN/,57RN01FAP1D1D1N1NNN/NNNNN	4.5 N·m [39.8 lb·in]

 For further details on ordering, see [Product Code](#) on page 8.

Group 1

Pump design

SNP1NN

SNP1NN pumps only include European flange and shaft configurations (code 01BA, 01DA, and 03CA).

SNP1NN 01BA (cut away)

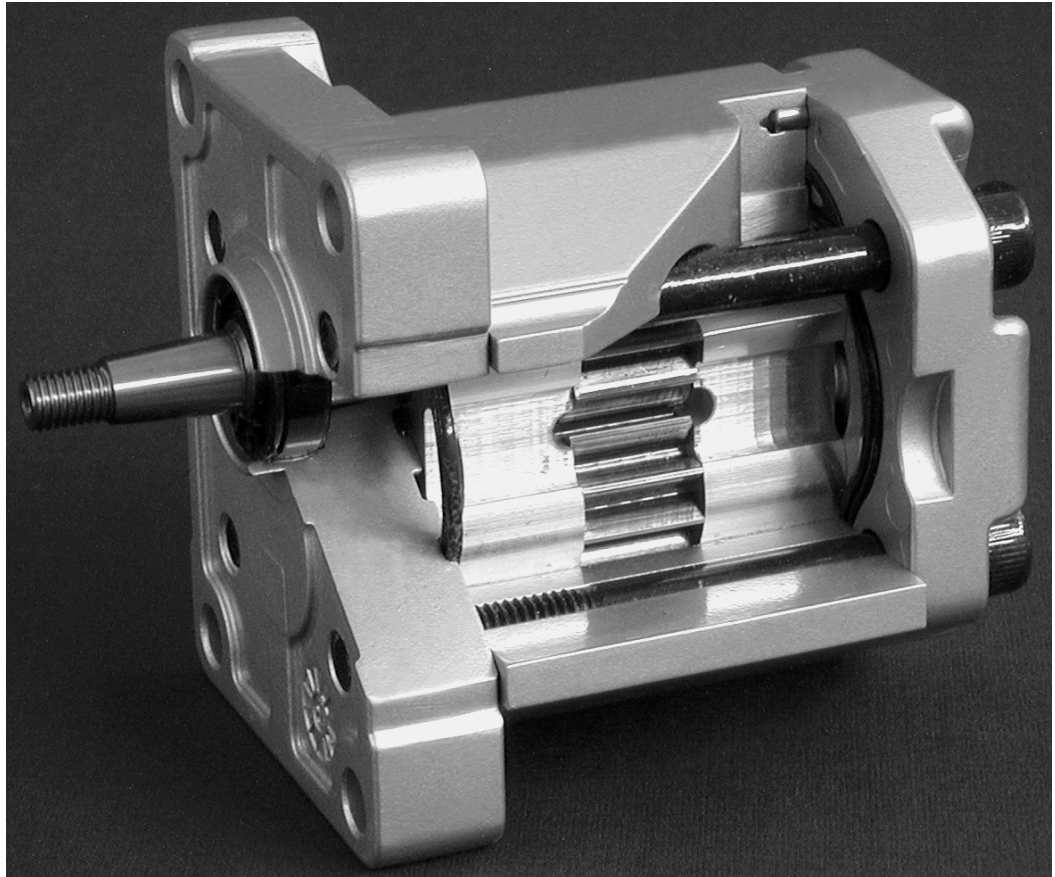

Group 1**SKP1NN**

SKP1NN has a larger diameter shaft than the SNP1NN. It spans the complete displacement range at higher pressures than the SNP1IN and the SNP1NN. Configurations include European and SAE flanges and shafts (code 02BB, 02FA, 06SA, and 06GA).

SKP1IN AND SNP1IN

Danfoss offers an optional integral relief valve integrated in the rear cover. It is drained internally and directs all flow from the pump outlet to the inlet when the outlet pressure reaches the valve setting. SNI1 pumps only include European flange and shaft configurations (code 01BA, 01DA, and 03CA).

SNP1IN 03CA (cut away)

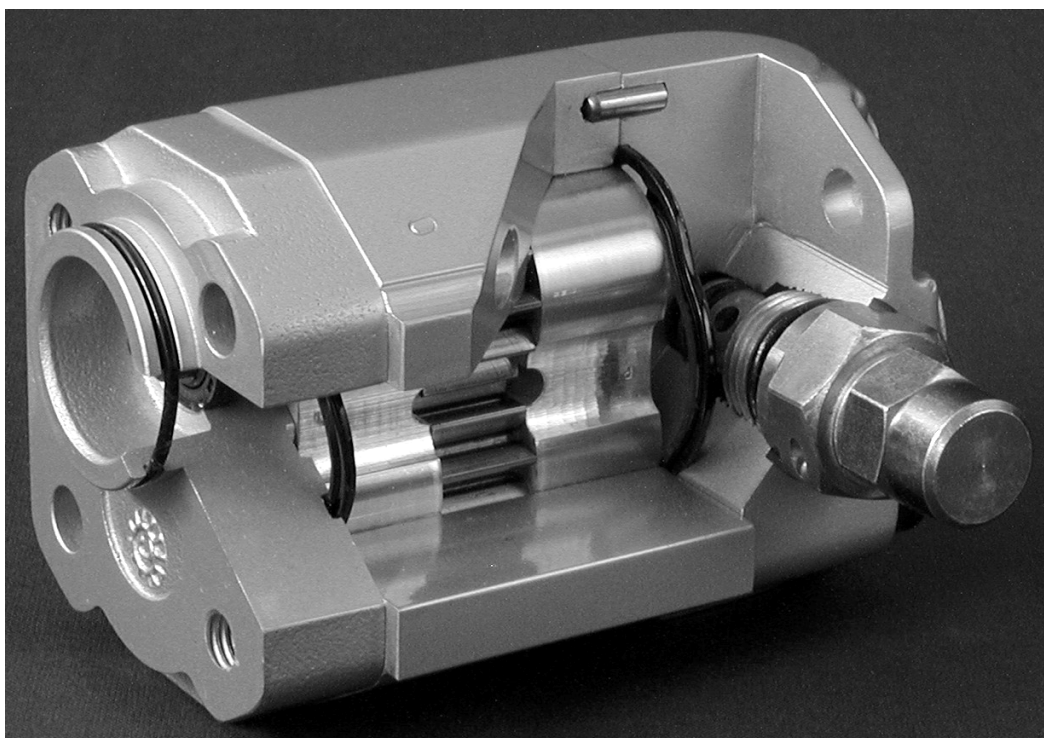

Group 1

Pump displacements

Quick reference chart for pump displacements vs. rated pressure

Quick reference chart for *pump* displacements vs. rated pressure

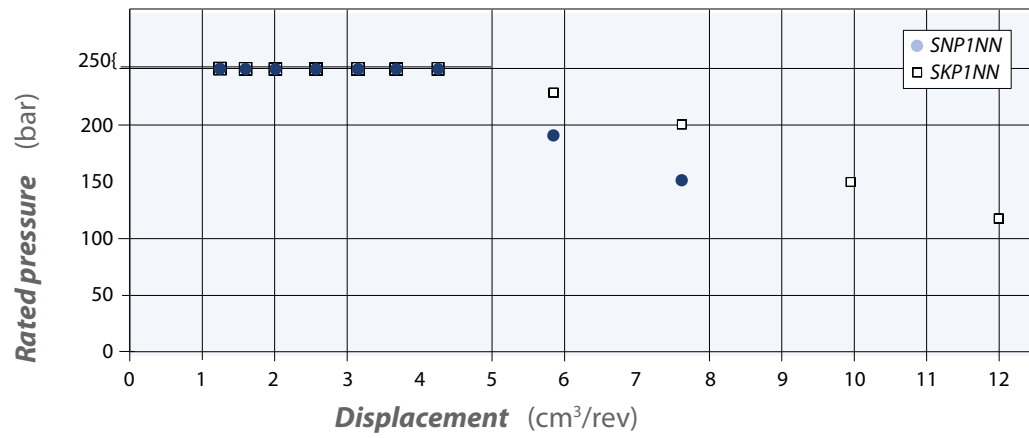

General Information

Technical data

		Frame size										
		1,2	1,7	2,2	2,6	3,2	3,8	4,3	6,0	7,8	010	012
Displacement	cm ³ /rev [in ³ /rev]	1.18 [0.072]	1.57 [0.096]	2.09 [0.128]	2.62 [0.160]	3.14 [0.192]	3.66 [0.223]	4.19 [0.256]	5.89 [0.359]	7.59 [0.463]	9.94 [0.607]	12.00 [0.732]
	SNP1NN											
Peak pressure	bar [psi]	270 [3915]	270 [3915]	270 [3915]	270 [3915]	270 [3915]	270 [3915]	270 [3915]	210 [3045]	170 [2465]		
Rated pressure		250 [3625]	250 [3625]	250 [3625]	250 [3625]	250 [3625]	250 [3625]	250 [3625]	190 [2760]	150 [2175]		
Minimum speed at 0-150 bar		800	800	600	600	600	600	500	500	500	-	-
Min. speed at 150 bar to rated pressure	min ⁻¹ (rpm)	1200	1200	1000	1000	1000	1000	800	800	800		
Maximum speed		4000	4000	4000	4000	4000	4000	3000	3000	3000		
SKP1NN*												
Peak pressure	bar [psi]	270 [3915]	270 [3915]	270 [3915]	270 [3915]	270 [3915]	270 [3915]	270 [3915]	250 [3625]	220 [3190]	170 [2465]	140 [2030]
Rated pressure		250 [3625]	250 [3625]	250 [3625]	250 [3625]	250 [3625]	250 [3625]	250 [3625]	230 [3335]	200 [2900]	150 [2175]	120 [1740]
Minimum speed at 0-150 bar		800	800	800	800	800	800	600	600	600	600	600
Min. speed at 150 bar to rated pressure	min ⁻¹ (rpm)	1200	1200	1000	1000	1000	1000	1000	800	800	800	-
Maximum speed		4000	4000	4000	4000	4000	4000	3000	3000	3000	2000	2000
All (SNP1NN, SKP1NN)												
Weight	kg [lb]	1.02 [2.26]	1.05 [2.31]	1.09 [2.40]	1.11 [2.45]	1.14 [2.51]	1.18 [2.60]	1.20 [2.65]	1.30 [2.87]	1.39 [3.06]	1.55 [3.42]	1.65 [3.64]
Moment of inertia of rotating components	x 10 ⁻⁶ kg·m ² [x 10 ⁻⁶ lb·ft ²]	3.2 [77]	3.7 [89]	4.4 [105]	5.1 [120]	5.7 [136]	6.4 [152]	7.1 [168]	9.3 [220]	11.4 [271]	14.6 [347]	17.1 [407]
Theoretical flow at maximum speed	l/min [US gal/ min]	4.72 [1.25]	6.28 [1.66]	8.36 [2.21]	10.48 [2.77]	12.56 [3.32]	14.64 [3.87]	12.57 [3.32]	17.67 [4.67]	22.77 [6.02]	19.88 [5.25]	24 [6.34]

*SKP1NN is a special version of the SNP1NN. It is designed to accommodate an SAE 9T 20/40 DP tooth splined shaft for higher torque applications.

1 kg·m² = 23.68 lb·ft²

General Information

 **Caution**

The rated and peak pressure mentioned are for pumps with flanged ports only. When threaded ports are required a derated performance has to be considered. To verify the compliance of an high pressure application with a threaded ports pump apply to a Danfoss representative.

Product Code

Model code

A Family

A						B	C	D	E	F	G	H	I	J	K	L	M	N	O	
•	•	•	•	•	•	/											/			

SNB1NN	Gear pump with inlet port on cover and outlet port on flange
SNP1NN	Standard gear pump
SNC1NN	Gear pump with inlet and outlet ports on rear cover
SNP1IN	Gear pump with internal drain relief valve
SKP1NN	High torque gear pump
SKP1IN	High torque gear pump with internal drain relief valve

B Displacement

A						B	C	D	E	F	G	H	I	J	K	L	M	N	O	
						/	•	•	•								/			

1,2	1,18 cc
1,7	1,57 cc
2,2	2,09 cc
2,6	2,62 cc
3,2	3,14 cc
3,8	3,66 cc
4,3	4,19 cc
6,0	5,89 cc
7,8	7,59 cc
010	9,94 cc
012	12,00 cc

C Rotation

A						B	C	D	E	F	G	H	I	J	K	L	M	N	O
						/		•								/			

L	Left rotation
R	Right rotation

D Project version

A						B	C	D	E	F	G	H	I	J	K	L	M	N	O
						/		•								/			

N	Standard gear pump
----------	--------------------

Product Code

E Mounting flange

A				B				C	D	E	F	G	H	I	J	K	L	M				N	O	
										•	•							/						

Code	Description (Type of flange • Type of drive gear • Preferred ports for configuration)
01	pilot Ø25,4+4 holes
02	pilot Ø30+4 holes
03	pilot Ø32+O-ring+2 holes through body
04	pilot Ø32+2 holes through body
06	SAE A-A pilot Ø50,8+ 2 holes

F Drive gear

A				B				C	D	E	F	G	H	I	J	K	L	M				N	O	
											•	•						/						

AA	Taper 1:5-M6-Key 2
BA	Taper 1:8-M7-Key 2,41
BB	Taper 1:8-M10x1-Key 3
CA	Tang 5x Ø10
CE	Tang 6,63x Ø11 - for SKP1xN
CM	Tang 5x Ø10-type 03 + w/o coupling
DA	SplinedZ15-m0,75-alfa 30°-L14 - for SNP1xx
DB	SplinedZ15-m0,75-alfa 30°-L14 - for SKP1xx
FA	Parallel Ø12-Thread M10x1-Key 3
GA	Parallel Ø12,7-Key 3.2
SA	SAE spline J498-9T-20/40

G Rear cover

A				B				C	D	E	F	G	H	I	J	K	L	M				N	O	
												•	•					/						

03	Cover 03 (used with flange 03-04)
08	Cover 08 with Inlet port 3/8" Gas
C1	Cover pump with front GAS Thread Inlet 3/8 ; Outlet 3/8
I1	Cover pump with relief valve
I3	Cover 03 with relief valve (used with flange 03)
P1	Std Cover pump

H Inlet size; I Outlet size

A				B				C	D	E	F	G	H	I	J	K	L	M				N	O
													•	•	•	•					/		

Technical Information
GearMe Aluminum Group 0 and Group 1 Pump

Product Code

NN	Without inlet	
B1	8x30xM6	
B2	13x30xM6	
C1	8x26xM5	
C2	12x26xM5	
C3	13, 5x30xM6	
D3	M14x1,5	
D5	M18x1,5	
D7	M22x1,5	
E3	9/16-18UNF	
E4	3/4-16UNF	
E5	7/8-14UNF	
F2	1/4 GAS	
F3	3/8 GAS	
F4	1/2 GAS	
H2	10xM12x1,5-ISO6149	
H4	12xM16x1,5-ISO6149	
H5	12xM18x 1, 5-ISO6149	
H7	13, 5xM22x 1, 5-ISO6149	

J Ports positions & Special body

A	B	C	D	E	F	G	H	I	J	K	L	M	N	O
									•	•	/			

NN	Std from catalogue
-----------	--------------------

K Seals

A	B	C	D	E	F	G	H	I	J	K	L	M	N	O
										•	/			

N	Standard NBR seal
A	Without shaft seal
B	With VITON seals

Product Code

L Screws

A					/	B					C	D	E	F	G	H	I	J	K	L	/	M					N	O	
					/																	•	/						

N	Std screws
B	GEOMET screws

M Set valve

A					/	B					C	D	E	F	G	H	I	J	K	L	/	M			N	O		
					/																		/	•	•	•		

NNN	No valve
V*	not defined-pressure no setting :oil ISO VG68-45°

* For details see [Variant codes for ordering integral relief valves](#) on page 35.

N Type mark

A					/	B					C	D	E	F	G	H	I	J	K	L	/	M					N	O	
					/																		/					•	

N	Standard Danfoss Marking
A	Standard Danfoss Marking+Customer Code
Z	Without Marking

O Mark position

A					/	B					C	D	E	F	G	H	I	J	K	L	/	M					N	O	
					/																		/						•

N	Std Marking position (on top)
A	Special Marking position on the bottom

Determination of Nominal Pump Sizes
Determination of nominal pump sizes

Use these formula to determine the nominal pump size for a specific application:

Based on SI units
Based on US units

$$\text{Output flow: } Q = \frac{Vg \cdot n \cdot \eta_v}{1000} \quad \text{l/min}$$

$$Q = \frac{Vg \cdot n \cdot \eta_v}{231} \quad \text{[US gal/min]}$$

$$\text{Input torque: } M = \frac{Vg \cdot \Delta p}{20 \cdot \pi \cdot \eta_m} \quad \text{N}\cdot\text{m}$$

$$M = \frac{Vg \cdot \Delta p}{2 \cdot \pi \cdot \eta_m} \quad \text{[lbf}\cdot\text{in]}$$

$$\text{Input power: } P = \frac{M \cdot n}{9550} = \frac{Q \cdot \Delta p}{600 \cdot \eta_t} \quad \text{kW}$$

$$P = \frac{M \cdot n}{63.025} = \frac{Q \cdot \Delta p}{1714 \cdot \eta_t} \quad \text{[hp]}$$

Vg =	Displacement per rev.	cm ³ /rev [in ³ /rev]
pHD =	Outlet pressure	bar [psi]
pND =	Inlet pressure	bar [psi]
Δp =	pHD – pND	bar [psi]
n =	Speed	min ⁻¹ (rpm)
η_v =	Volumetric efficiency	
η_m =	Mechanical (torque) efficiency	
η_t =	Overall efficiency (η _v · η _m)	

System Requirements

Pressure

The inlet vacuum must be controlled in order to realize expected pump life and performance. The system design must meet inlet pressure requirements during all modes of operation. Expect lower inlet pressures during cold start. It should improve quickly as the fluid warms.

Max. continuous vacuum	bar abs. [in. Hg]	0.8 [23.6]
Max. intermittent vacuum		0.6 [17.7]
Max. pressure		4.0 [118.1]

Peak pressure is the highest intermittent pressure allowed. The relief valve overshoot (reaction time) determines peak pressure. It is assumed to occur for less than 100 ms. The accompanying illustration shows peak pressure in relation to rated pressure and reaction time (100 ms maximum).

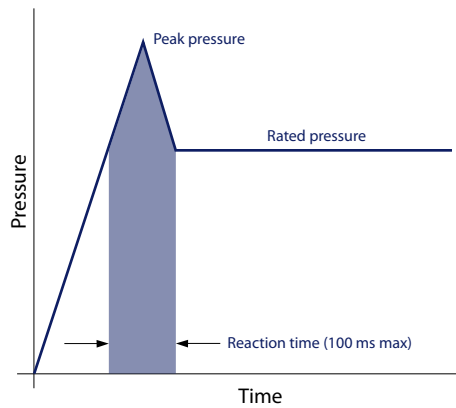

Rated pressure is the average, regularly occurring, operating pressure that should yield satisfactory product life. The maximum machine load demand determines rated pressure. For all systems, the load should move below this pressure.

System pressure is the differential of pressure between the outlet and inlet ports. It is a dominant operating variable affecting hydraulic unit life. High system pressure, resulting from high load, reduces expected life. System pressure must remain at, or below, rated pressure during normal operation to achieve expected life.

Speed

Maximum speed is the limit recommended by Danfoss for a particular gear pump when operating at rated pressure. It is the highest speed at which normal life can be expected.

The lower limit of operating speed is the **minimum speed**. It is the lowest speed at which normal life can be expected. The minimum speed increases as operating pressure increases. When operating under higher pressures, a higher minimum speed must be maintained, as illustrated here.

System Requirements

Speed versus pressure

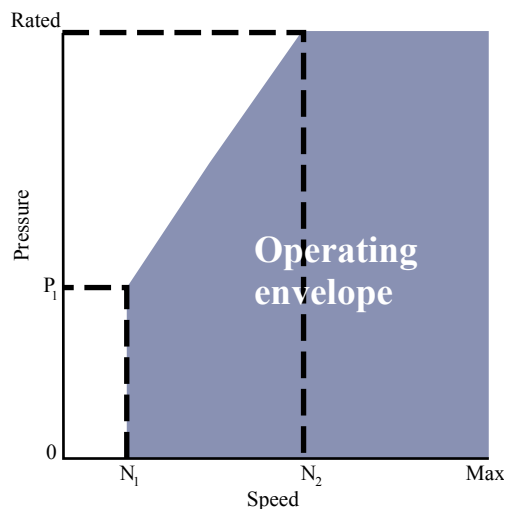

Where:

N_1 = Minimum speed at 100 bar

N_2 = Minimum speed at 180 bar

Hydraulic fluids

Ratings and data for SNP1NN, and SKP1NN gear pumps are based on operating with premium hydraulic fluids containing oxidation, rust, and foam inhibitors. These fluids must possess good thermal and hydrolytic stability to prevent wear, erosion, and corrosion of internal components. They include:

- Hydraulic fluids following DIN 51524, part 2 (HLP) and part 3 (HVL) specifications
- API CD engine oils conforming to SAE J183
- M2C33F or G automatic transmission fluids
- Certain agricultural tractor fluids

Use only clean fluid in the pump and hydraulic circuit.

! Caution

Never mix hydraulic fluids.

Temperature and viscosity

Temperature and viscosity requirements must be concurrently satisfied. Use petroleum / mineral-based fluids.

High temperature limits apply at the inlet port to the pump. The pump should run at or below the maximum continuous temperature. The peak temperature is based on material properties. Don't exceed it.

Cold oil, generally, doesn't affect the durability of pump components. It may affect the ability of oil to flow and transmit power. For this reason, keep the temperature at 16 °C [60 °F] above the pour point of the hydraulic fluid.

Minimum (cold start) temperature relates to the physical properties of component materials.

Minimum viscosity occurs only during brief occasions of maximum ambient temperature and severe duty cycle operation. You will encounter maximum viscosity only at cold start. During this condition, limit speeds until the system warms up. Size heat exchangers to keep the fluid within these limits. Test regularly to verify that these temperatures and viscosity limits aren't exceeded. For maximum unit efficiency and bearing life, keep the fluid viscosity in the recommended viscosity range.

System Requirements

Fluid viscosity

Maximum (cold start)	mm ² /s [SUS]	1000 [1600]
Recommended range		12-60 [66-290]
Minimum		10 [60]

Temperature (with standard NBR seals)

Minimum (cold start)	°C [°F]	-20 [-4]
Maximum continuous		80 [176]
Peak (intermittent)		90 [194]

Filtration

Filters

Use a filter that conforms to Class 22/18/13 of ISO 4406 (or better). It may be on the pump outlet (pressure filtration), inlet (suction filtration), or reservoir return (return-line filtration).

Selecting a filter

When selecting a filter, please consider:

- contaminant ingress rate (determined by factors such as the number of actuators used in the system)
- generation of contaminants in the system
- required fluid cleanliness
- desired maintenance interval
- filtration requirements of other system components

Measure filter efficiency with a Beta ratio (β_x). For:

- suction filtration, with controlled reservoir ingress, use a $\beta_{35-45} = 75$ filter
- return or pressure filtration, use a pressure filtration with an efficiency of $\beta_{10} = 75$

β_x ratio is a measure of filter efficiency defined by ISO 4572. It is the ratio of the number of particles greater than a given diameter ("x" in microns) upstream of the filter to the number of these particles downstream of the filter.

Fluid cleanliness level and β_x ratio

Fluid cleanliness level (per ISO 4406)	Class 22/18/13 or better
β_x ratio (suction filtration)	$\beta_{35-45} = 75$ and $\beta_{10} = 2$
β_x ratio (pressure or return filtration)	$\beta_{10} = 75$
Recommended inlet screen size	100-125 μm [0.004-0.005 in]

The filtration requirements for each system are unique. Evaluate filtration system capacity by monitoring and testing prototypes.

Reservoir

The **reservoir** provides clean fluid, dissipates heat, removes entrained air, and allows fluid volume changes associated with fluid expansion and cylinder differential volumes. A correctly sized reservoir accommodates maximum volume changes during all system operating modes. It promotes deaeration of the fluid as it passes through, and accommodates a fluid dwell-time between 60 and 180 seconds, allowing entrained air to escape.

System Requirements

Minimum reservoir capacity depends on the volume required to cool and hold the oil from all retracted cylinders, allowing for expansion due to temperature changes. A fluid volume of 1 to 3 times the pump output flow (per minute) is satisfactory. The minimum reservoir capacity is 125% of the fluid volume.

Install the suction line above the bottom of the reservoir to take advantage of gravity separation and prevent large foreign particles from entering the line. Cover the line with a 100-125 micron screen. The pump should be below the lowest expected fluid level. Put the return-line below the lowest expected fluid level to allow discharge into the reservoir for maximum dwell and efficient deaeration. A baffle (or baffles) between the return and suction lines promotes deaeration and reduces fluid surges.

Line sizing

Choose pipe sizes that accommodate minimum fluid velocity to reduce system noise, pressure drops, and overheating. This maximizes system life and performance.

Design inlet piping that maintains continuous pump inlet pressure above 0.8 bar absolute during normal operation. The line velocity should not exceed the values in this table:

Maximum line velocity

Inlet	m/s [ft/sec]	2.5 [8.2]
Outlet		5.0 [16.4]
Return		3.0 [9.8]

Most systems use hydraulic oil containing 10% dissolved air by volume. Under high inlet vacuum conditions the oil releases bubbles. They collapse when subjected to pressure, resulting in cavitation, causing adjacent metal surfaces to erode. **Over-aeration** is the result of air leaks on the inlet side of the pump, and flow-line restrictions. These include inadequate pipe sizes, sharp bends, or elbow fittings, causing a reduction of flow line cross sectional area. This problem will not occur if inlet vacuum and rated speed requirements are maintained, and reservoir size and location are adequate.

Pump drive

Shaft options for Group 1 gear pumps include tapered, tang, splined, or parallel shafts. They are suitable for a wide range of direct and indirect drive applications for radial and thrust loads.

Plug-in drives, acceptable only with a splined shaft, can impose severe radial loads when the mating spline is rigidly supported. Increasing spline clearance does not alleviate this condition.

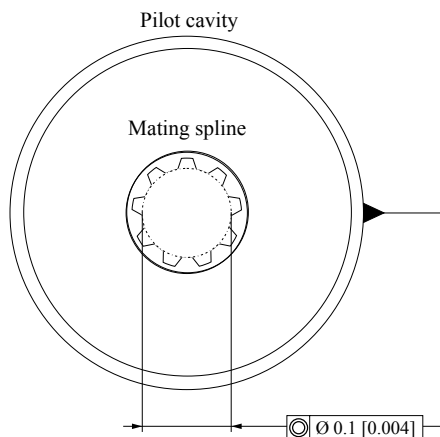

Use **plug-in drives** if the concentricity between the mating spline and pilot diameter is within 0.1 mm [0.004 in]. Lubricate the drive by flooding it with oil. A 3-piece coupling minimizes radial or thrust shaft loads.

System Requirements

⚠ Caution

In order to avoid spline shaft damages it is recommended to use carburized and hardened steel couplings with 80-82 HRA surface hardness.

Allowable **radial shaft loads** are a function of the load position, load orientation, and operating pressure of the hydraulic pump. All external shaft loads have an effect on bearing life, and may affect pump performance.

In applications where external shaft loads can't be avoided, minimize the impact on the pump by optimizing the orientation and magnitude of the load. Use a tapered input shaft; don't use splined shafts for belt or gear drive applications. A spring-loaded belt tension-device is recommended for belt drive applications to avoid excessive tension. Avoid thrust loads in either direction.

Pump drive data form

Contact Danfoss if continuously applied external radial or thrust loads occur. Fill out this page and send the complete form to your Danfoss representative for an assistance in applying pumps with belt or gear drive. This illustration shows a pump with counterclockwise orientation:

Optimal radial load position

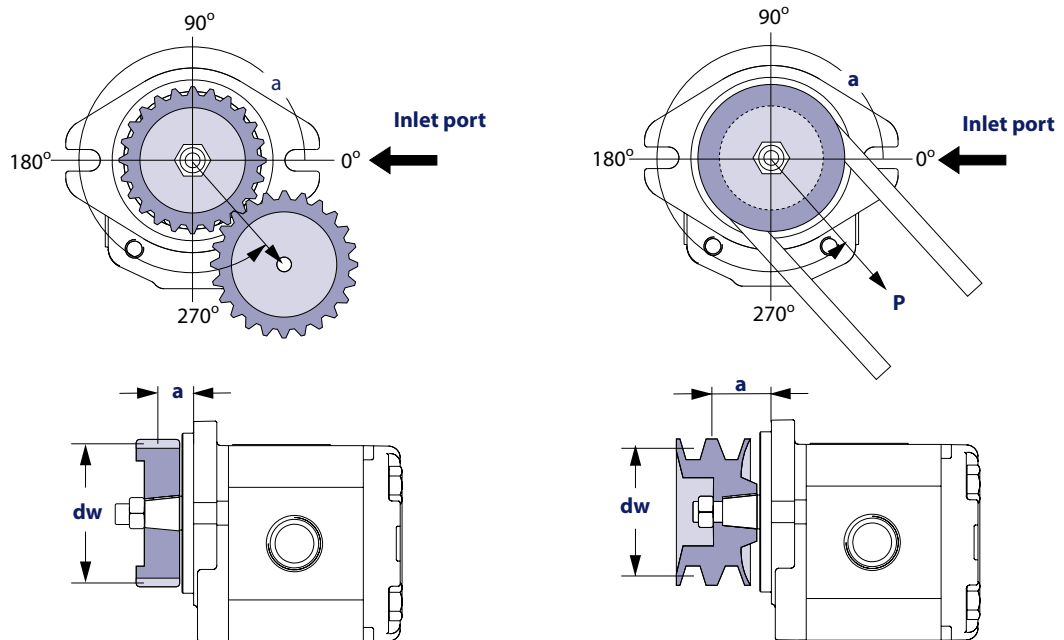

Application data

Item	Value	Unit
Pump displacement		cm ³ /rev [in ³ /rev]
Rated system pressure		bar psi
Relief valve setting		
Pump shaft rotation		left right
Pump minimum speed		min ⁻¹ (rpm)
Pump maximum speed		
Drive gear helix angle (gear drive only)		degree
Belt type (gear drive only)		V notch
Belt tension (gear drive only)	P	N lbf

System Requirements

Application data (continued)

Item		Value	Unit
Angular orientation of gear or belt to inlet port	α		degree
Pitch diameter of gear or pulley	dw		mm in
Distance from flange to center of gear or pulley	a		

Pump Life

Pump life is a function of speed, system pressure, and other system parameters (such as fluid quality and cleanliness).

All Danfoss gear pumps use hydrodynamic journal bearings that have an oil film maintained between the gear/shaft and bearing surfaces at all times. If the oil film is sufficiently sustained through proper system maintenance and operating within recommended limits, long life can be expected.

[B₁₀ life expectancy number is generally associated with rolling element bearings. It does not exist for hydrodynamic bearings.](#)

High pressure, resulting from high loads, impacts pump life. When submitting an application for review, provide machine duty cycle data that includes percentages of time at various loads and speeds. We strongly recommend a prototype testing program to verify operating parameters and their impact on life expectancy before finalizing any system design.

Sound levels

Noise is unwanted sound. Fluid power systems create noise. There are many techniques available to minimize noise. Understanding how it's generated and transmitted is necessary to apply these methods effectively.

Noise energy is transmitted as fluid borne noise (pressure ripple) or structure borne noise. **Pressure ripple** is the result of the number of pumping elements (gear teeth) delivering oil to the outlet and the pump's ability to gradually change the volume of each pumping element from low to high pressure. Pressure ripple is affected by the compressibility of the oil as each pumping element discharges into the outlet of the pump. Pressure pulsations travel along hydraulic lines at the speed of sound (about 1400 m/s in oil) until there is a change in the system (as with an elbow fitting). Thus, the pressure pulsation amplitude varies with overall line length and position.

Structure borne noise may be transmitted wherever the pump casing is connected to the rest of the system.

The way circuit components respond to excitation depends on their size, form, and mounting. Because of this, a system line may actually have a greater noise level than the pump. To minimize noise, use:

- flexible hoses (if you must use steel plumbing, clamp the lines).
- flexible (rubber) mounts to minimize other structure borne noise.

Pump Performance

Pump performance graphs

The following graphs provide typical output flow and input power for Group 1 pumps at various working pressures. Data were taken using ISO VG46 petroleum /mineral based fluid at 50°C (viscosity at 28 mm²/s [cSt]).

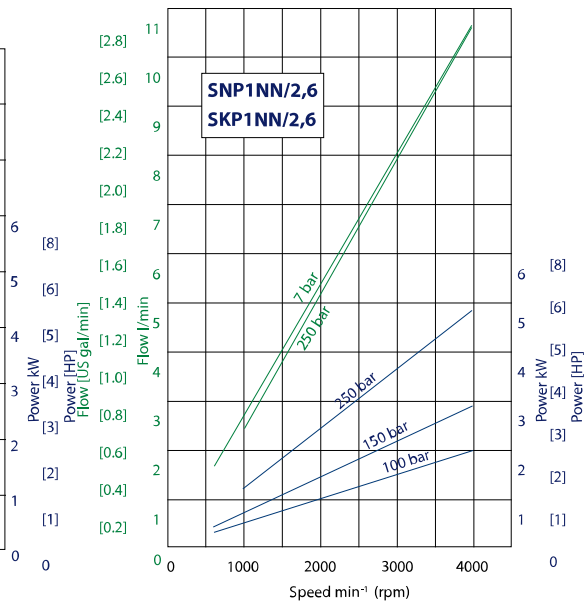
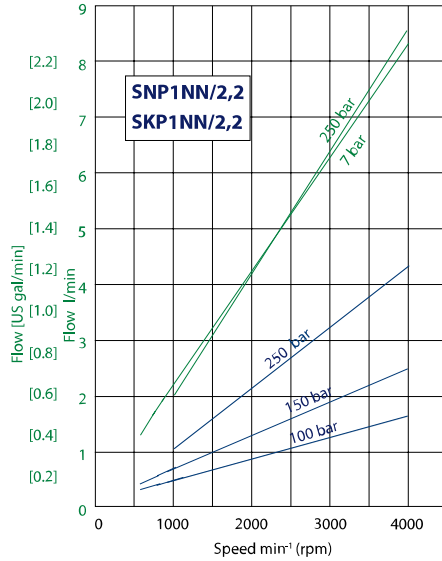
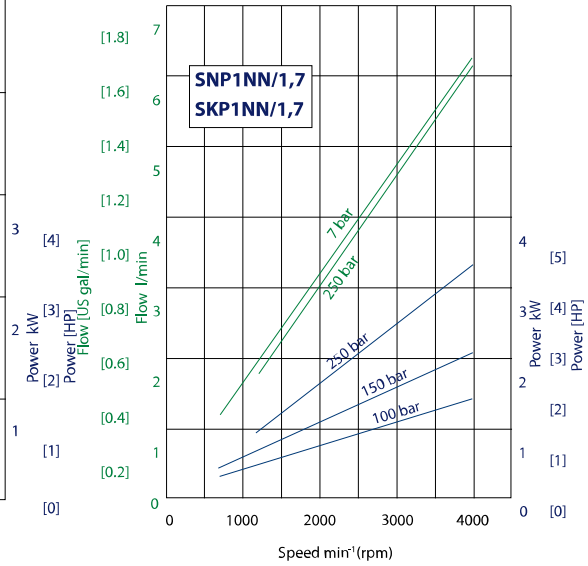
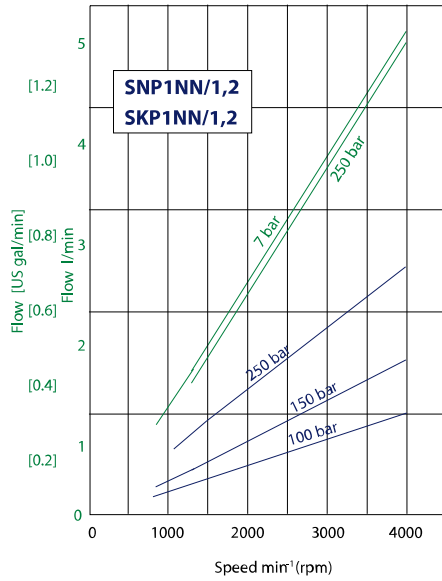

Pump Performance

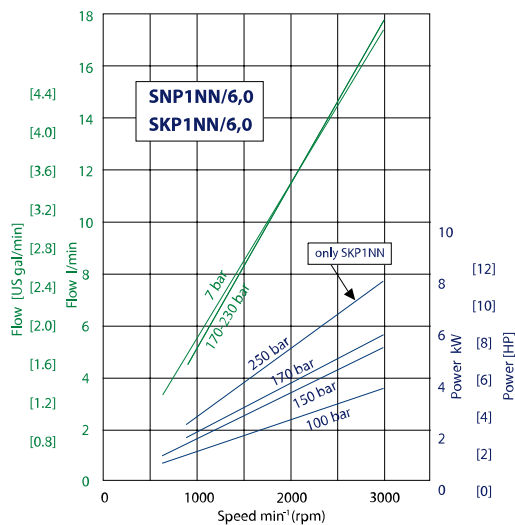
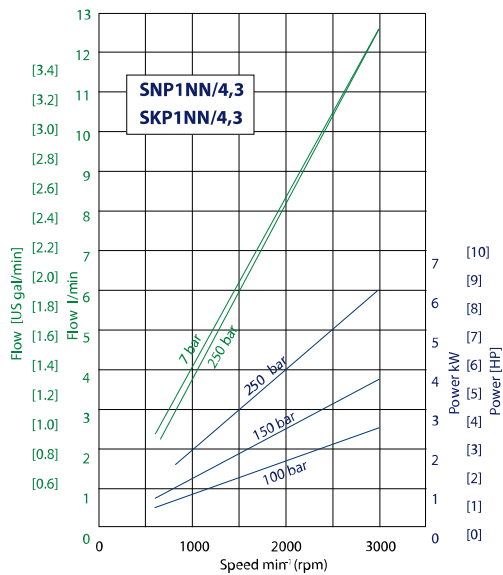
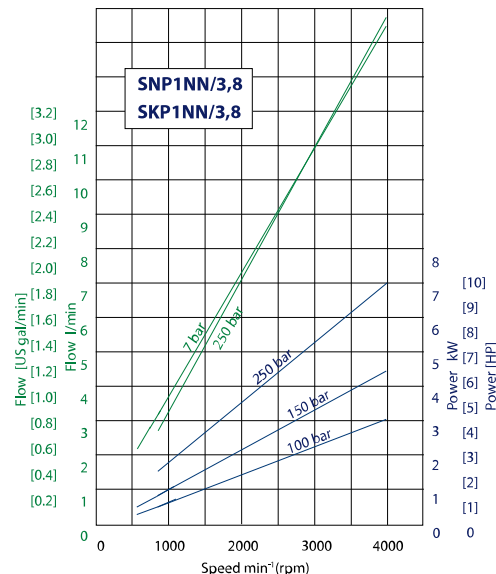
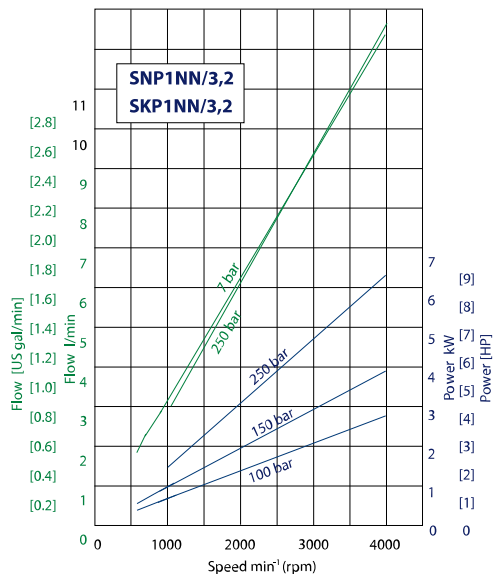

Pump Performance

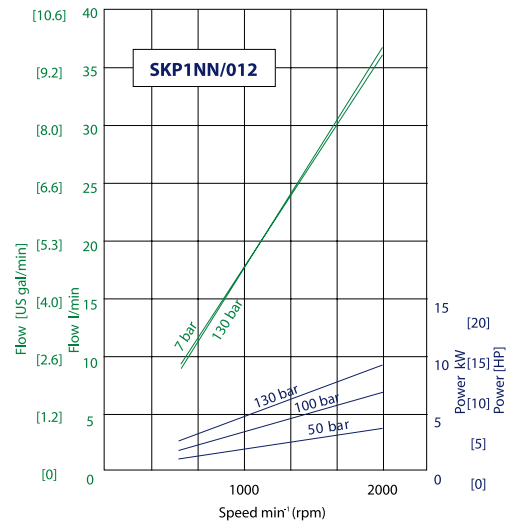
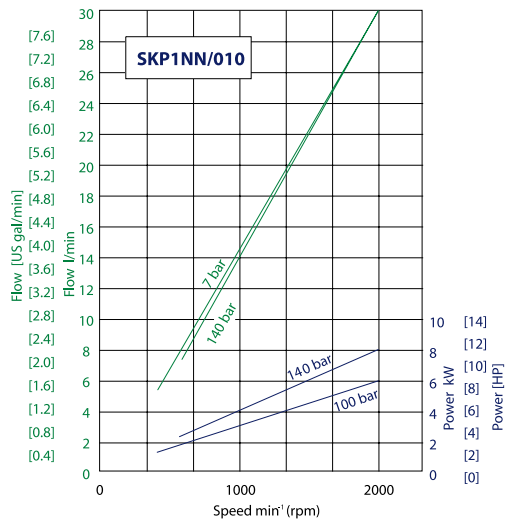
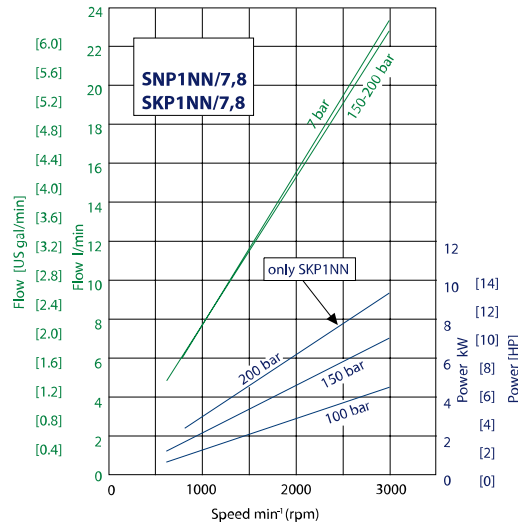



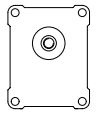
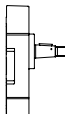
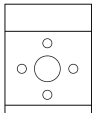
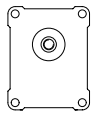
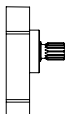
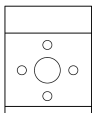
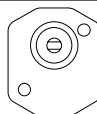
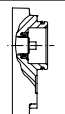
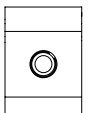
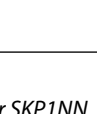
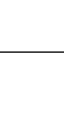
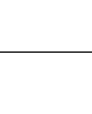

Product Options

Flange, shaft and port configurations

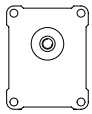
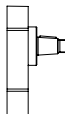
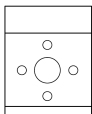
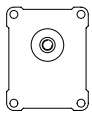
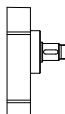
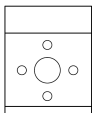
Code	Flange	Shaft	Port
01BA	25.4 mm [1.0 in] pilot Ø European 4-bolt 	1:8 tapered 	European flanged in + pattern 
01DA	25.4 mm [1.0 in] pilot Ø European 4-bolt 	15-teeth splined m = 0.75 a = 30o 	European flanged in + pattern 
03CA	pilot Ø32 + O-ring + 2 holes through body 	Danfoss tang 	Threaded metric port 
04AA	pilot Ø32 + O-ring + 2 holes through body 	1:5 tapered 	Threaded metric port 

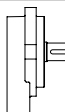
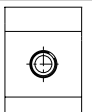
Flange, shaft and port configurations for SKP1NN

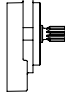
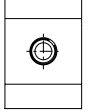
Code	Flange	Shaft	Port
02BB	30 mm [1.181] pilot Ø European 4-bolt 	1:8 tapered 	European flanged in + pattern 
02FA	30 mm [1.181] pilot Ø European 4-bolt 	12 mm [0.472 in] parallel 	European flanged in + pattern 
06GA	SAE A-A 2-bolt 	12.7 mm [0.5 in] parallel 	Threaded SAE O-Ring boss 
06SA	SAE A-A 2-bolt 	9-teeth splined SAE spline J 498-9T-20/40DP 	Threaded SAE O-Ring boss 

Shaft options

Direction is viewed facing the shaft. Group 1 pumps are available with a variety of tang, splined, parallel, and tapered shaft ends. Not all shaft styles are available with all flange styles.

Shaft availability and nominal torque capability

A	B	C	D	E	F	G	H	I	J	K	L	M	N	O
	/				•	•					/			

Product Options

Shaft		Mounting flange code with maximum torque in Nm [lb•in]				
Code	Description	01	02	03	04	06
AA	Taper 1:5-M6				25 [221]	
BA	Taper 1:8-M7	25 [221]				
BB	Taper 1:8-M10		50 [442]			
CA	Tang 5x Ø10			14 [124]		
CE	Tang 6,63x Ø11					21 [186]
CM	Tang 5x Ø10-type 03 + w/o coupling			14 [124]		
DA	Splined Z15-m0,75-alfa 30°-L14	35 [309]				
DB	Splined Z15-m0,75-alfa 30°-L14		35 [309]			
FA	Parallel Ø12-Thread M10x1		24 [212]			
GA	Parallel Ø12,7-Key 3.2					32 [283]
SA	SAE spline J498-9T-20/40					34 [301]

Danfoss recommends mating splines conform to SAE J498 or DIN 5482.

Danfoss external SAE splines have a flat root side fit with circular tooth thickness reduced by 0.127 mm [0.005 in] in respect to class 1 fit. Dimensions are modified to assure a clearance fit with the mating spline.

Caution

Shaft torque capability may limit allowable pressure. Torque ratings assume no external radial loading. Applied torque must not exceed these limits, regardless of stated pressure parameters. Maximum torque ratings are based on shaft torsional fatigue strength.

Various port configurations are available on Group 1 pumps. They include:

- European standard flanged ports
- German standard flanged ports
- Gas threaded ports (BSPP)
- O-Ring boss (following SAE J1926/1 [ISO 11926-1] UNF threads, standard)

For a table of dimensions, see [Ports](#) on page 33.

Inlet/Outlet port configurations

A	B	C	D	E	F	G	H	I	J	K	L	M	N	O
							•	•	•	•				

B1	8x30xM6	Flanged port with threaded holes in X pattern, in center of body
B2	13x30xM6	
C1	8x26xM5	Flanged port with threaded holes in + pattern (European standard ports)
C2	12x26xM5	
C3	13,5x30xM6	
D3	M14x1,5	Threaded metric port
D5	M18x1,5	
D7	M22x1,5	

Product Options

E3	9/16-18UNF	Threaded SAE, O-Ring boss port
E4	3/4 -16UNF	
E5	7/8-14UNF	
F2	1/4 GAS	Threaded GAS (BSPP) port
F3	3/8 GAS	
F4	1/2 GAS	
H2	M12x1,5	Threaded metric port ISO 6149
H4	M16x1,5	
H5	M18x1,5	
H7	M22x1,5	

Ports

Available ports

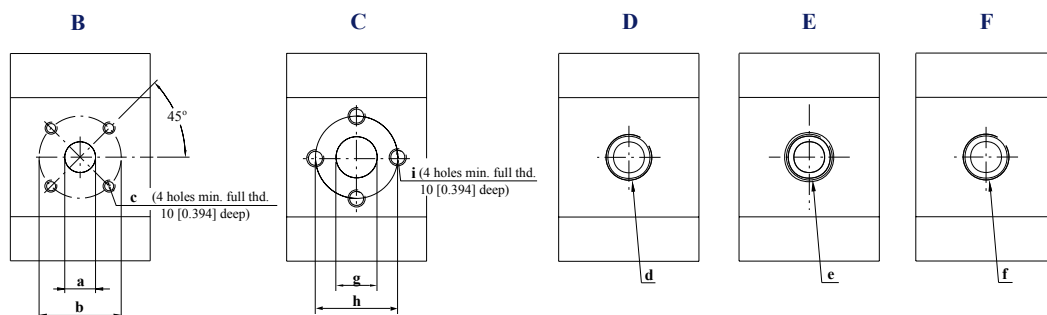

Dimensions of Group 1 pump ports

Port type		B			C			D	E	F
Port dimension		a	b	c	g	h	i	d	e	f
1,2	Inlet	13 [0.512]	30 [1.181]	M6	12 [0.462]	26 [1.024]	M5	M18x1.5	3/4-16UNF-2B	3/8 Gas (BSPP)
	Outlet	8 [0.315]	30 [1.181]	M6	12 [0.462]	26 [1.024]	M5	M14x1.5	9/16-18UNF-2B	3/8 Gas (BSPP)
1,7	Inlet	13 [0.512]	30 [1.181]	M6	12 [0.462]	26 [1.024]	M5	M18x1.5	3/4-16UNF-2B	3/8 Gas (BSPP)
	Outlet	8 [0.315]	30 [1.181]	M6	12 [0.462]	26 [1.024]	M5	M14x1.5	9/16-18UNF-2B	3/8 Gas (BSPP)
2,2	Inlet	13 [0.512]	30 [1.181]	M6	12 [0.462]	26 [1.024]	M5	M18x1.5	3/4-16UNF-2B	3/8 Gas (BSPP)
	Outlet	8 [0.315]	30 [1.181]	M6	12 [0.462]	26 [1.024]	M5	M14x1.5	9/16-18UNF-2B	3/8 Gas (BSPP)
2,6	Inlet	13 [0.512]	30 [1.181]	M6	12 [0.462]	26 [1.024]	M5	M18x1.5	3/4-16UNF-2B	3/8 Gas (BSPP)
	Outlet	8 [0.315]	30 [1.181]	M6	12 [0.462]	26 [1.024]	M5	M14x1.5	9/16-18UNF-2B	3/8 Gas (BSPP)
3,2	Inlet	13 [0.512]	30 [1.181]	M6	12 [0.462]	26 [1.024]	M5	M18x1.5	3/4-16UNF-2B	3/8 Gas (BSPP)
	Outlet	8 [0.315]	30 [1.181]	M6	12 [0.462]	26 [1.024]	M5	M14x1.5	9/16-18UNF-2B	3/8 Gas (BSPP)
3,8	Inlet	13 [0.512]	30 [1.181]	M6	12 [0.462]	26 [1.024]	M5	M18x1.5	3/4-16UNF-2B	3/8 Gas (BSPP)
	Outlet	8 [0.315]	30 [1.181]	M6	12 [0.462]	26 [1.024]	M5	M18x1.5	9/16-18UNF-2B	3/8 Gas (BSPP)
4,3	Inlet	13 [0.512]	30 [1.181]	M6	12 [0.462]	26 [1.024]	M5	M18x1.5	3/4-16UNF-2B	3/8 Gas (BSPP)
	Outlet	8 [0.315]	30 [1.181]	M6	12 [0.462]	26 [1.024]	M5	M18x1.5	9/16-18UNF-2B	3/8 Gas (BSPP)
6,0	Inlet	13 [0.512]	30 [1.181]	M6	12 [0.462]	26 [1.024]	M5	M18x1.5	3/4-16UNF-2B	3/8 Gas (BSPP)
	Outlet	13 [0.512]	30 [1.181]	M6	12 [0.462]	26 [1.024]	M5	M18x1.5	9/16-18UNF-2B	3/8 Gas (BSPP)

Product Options

Dimensions of Group 1 pump ports (continued)

Port type		B			C			D	E	F
Port dimension		a	b	c	g	h	i	d	e	f
7,8	Inlet	13 [0.512]	30 [1.181]	M6	12 [0.462]	26 [1.024]	M5	M18x1.5	¾-16UNF-2B	3/8 Gas (BSPP)
	Outlet	13 [0.512]	30 [1.181]	M6	12 [0.462]	26 [1.024]	M5	M18x1.5	9/16-18UNF-2B	3/8 Gas (BSPP)
010	Inlet	13 [0.512]	30 [1.181]	M6	12 [0.462]	26 [1.024]	M5	M18x1.5	¾-16UNF-2B	3/8 Gas (BSPP)
	Outlet	13 [0.512]	30 [1.181]	M6	12 [0.462]	26 [1.024]	M5	M18x1.5	9/16-18UNF-2B	3/8 Gas (BSPP)
012	Inlet	13 [0.512]	30 [1.181]	M6	12 [0.462]	26 [1.024]	M5	M18x1.5	¾-16UNF-2B	3/8 Gas (BSPP)
	Outlet	13 [0.512]	30 [1.181]	M6	12 [0.462]	26 [1.024]	M5	M18x1.5	9/16-18UNF-2B	3/8 Gas (BSPP)

SNP1IN

Danfoss offers an optional integral relief valve integrated in the rear cover. It is drained internally and directs all flow from the pump outlet to the inlet when the outlet pressure reaches the valve setting.

! Caution

When the relief valve is operating in bypass condition, rapid heat generation occurs. If this bypass condition continues, the pump prematurely fails. The reason for this is that it is a rule, not an exception.

Valve performance graph

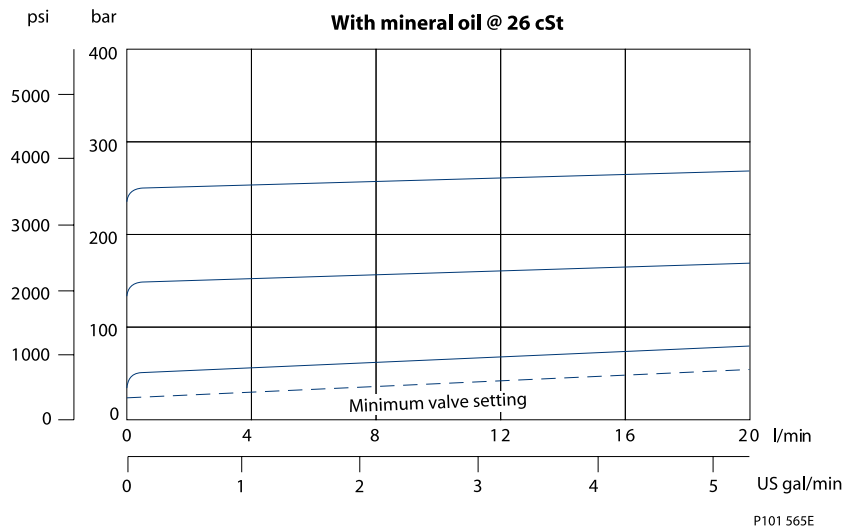

Product Options

Dimensions

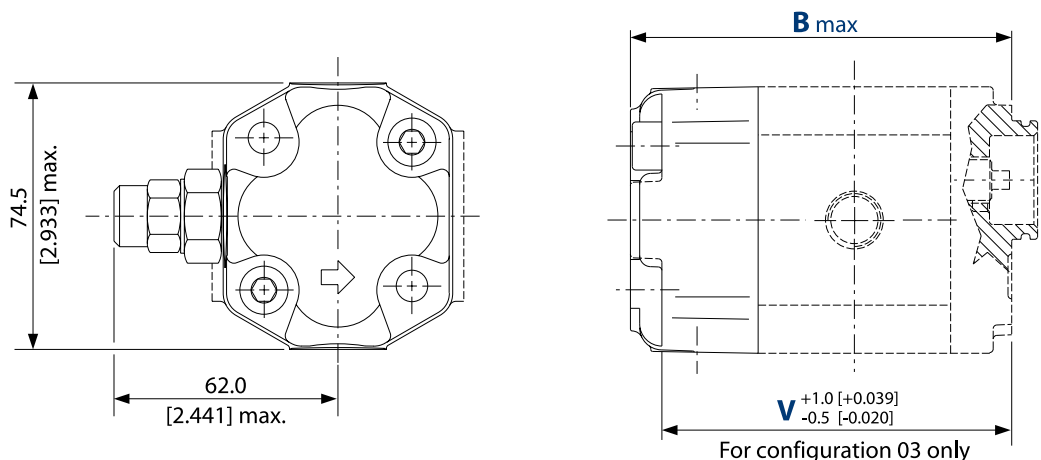

For configuration 06 (SAE A-A) dimension B and V have to be increased 4.5 mm [0.177 in].

Integral relief valve and covers dimensions

Type (displacement)	1,2	1,7	2,2	2,6	3,2	3,8	4,3	6,0	7,8	010	012	
Dimensions mm [in]	B	95.5 [3.760]	97 [3.819]	99 [3.989]	101 [3.976]	103 [4.055]	105 [4.134]	107 [4.213]	113.5 [4.468]	120 [4.724]	129 [5.079]	137 [5.394]
	V	85.0 [3.346]	86.5 [3.406]	88.5 [3.484]	90.5 [3.563]	92.5 [3.642]	94.5 [3.720]	96.5 [3.799]	103.0 [4.055]	109.5 [4.311]	118.5 [4.665]	126.5 [4.980]

Variant codes for ordering integral relief valves

These tables detail the various codes for ordering integral relief valves:

A	B	C	D	E	F	G	H	I	J	K	L	M	N	O
	/										/	•	•	•

Code	Pump speed for RV setting min-1 (rpm)
A	Not defined
C	500
E	1000
F	1250
G	1500
K	2000
I	2250
L	2500
M	2800
N	3000
O	3250

Product Options

Code	Pressure setting bar [psi]
A	No setting
B	No valve
C	18 [261]
D	25 [363]
E	30 [435]
F	35 [508]
G	40 [580]
K	50 [725]
L	60 [870]
M	70 [1015]
N	80 [1160]
O	90 [1305]
P	100 [1450]
Q	110 [1595]
R	120 [1740]
S	130 [1885]
T	140 [2030]
U	160 [2320]
V	170 [2465]
W	180 [2611]
X	210 [3045]
Y	240 [3480]
Z	250 [3626]

Integral relief valve schematic

Valve schematic

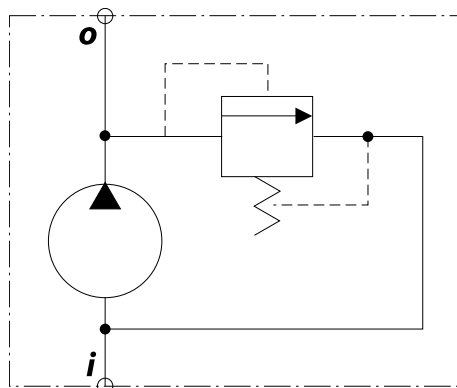

Dimensions

SNP1NN - 01BA and 01DA

This drawing shows the standard porting for 01BA and 01DA. Available in Series SNP1NN only.

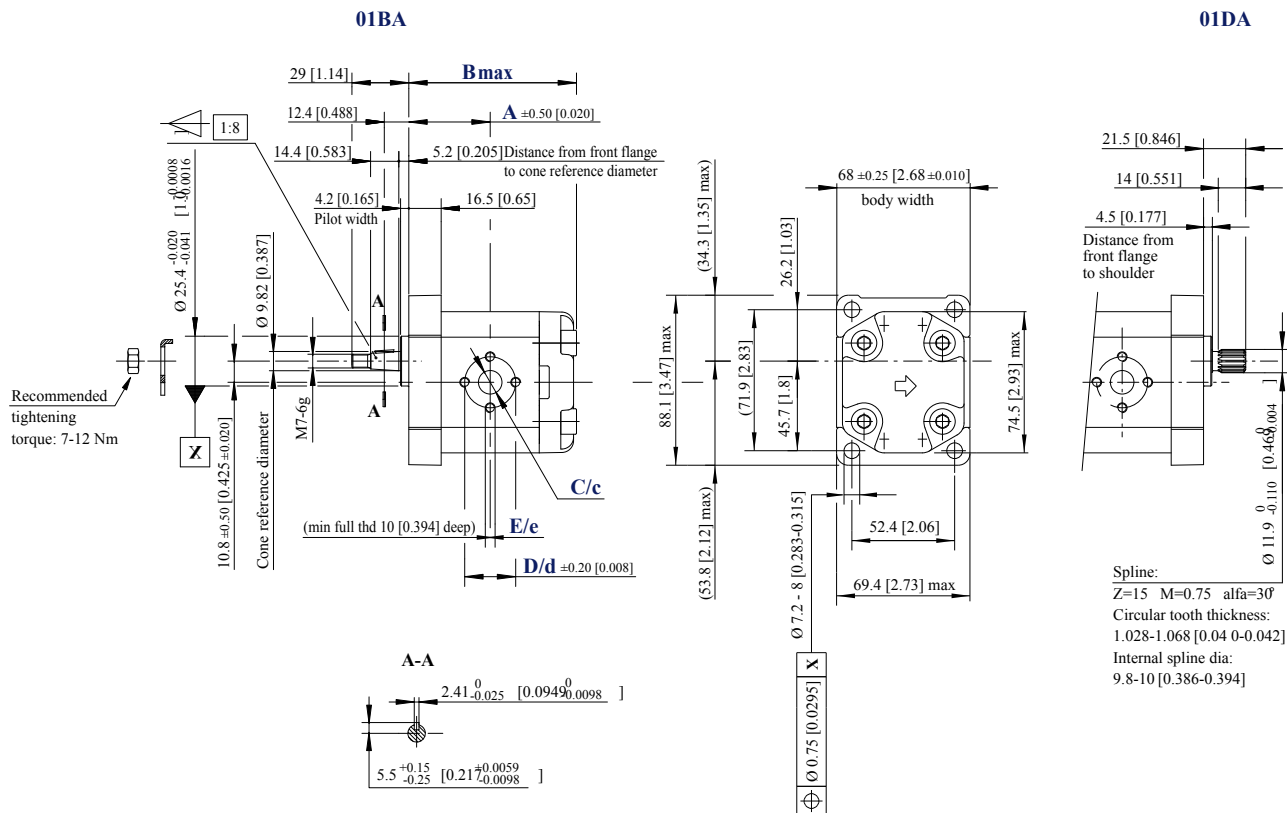

SNP1NN – 01BA and 01DA dimensions

Frame size		1,2	1,7	2,2	2,6	3,2	3,8	4,3	6,0	7,8
Dimension	A	37.75 [1.486]	38.5 [1.516]	39.5 [1.555]	40.5 [1.634]	41.5 [1.634]	42.5 [1.673]	43.5 [1.713]	46.75 [1.841]	50.0 [1.969]
	B	79.5 [3.130]	81.0 [3.189]	83.0 [3.268]	85.0 [3.346]	87.0 [3.425]	89.0 [3.504]	91.0 [3.583]	97.5 [3.839]	104.0 [4.094]
Inlet/Outlet	C/c	12 [0.472]								
	D/d	26 [1.024]								
	E/e	M5								

Model code examples and maximum shaft torque

Flange/drive gear	Model code example	Maximum shaft torque
01BA	SNP1NN/3,8RN01BAP1C2C2NNNN/NNNNN	25 N·m [221 lb·in]
01DA	SNP1NN/6,0LN01DAP1C2C2NNNN/NNNNN	35 N·m [310 lb·in]

For further details on ordering, see [Model code](#).

Dimensions

SKP1NN – 02BB and 02FA

This drawing shows the standard porting for 02BB and 02FA. Available in Series SKP1NN only.

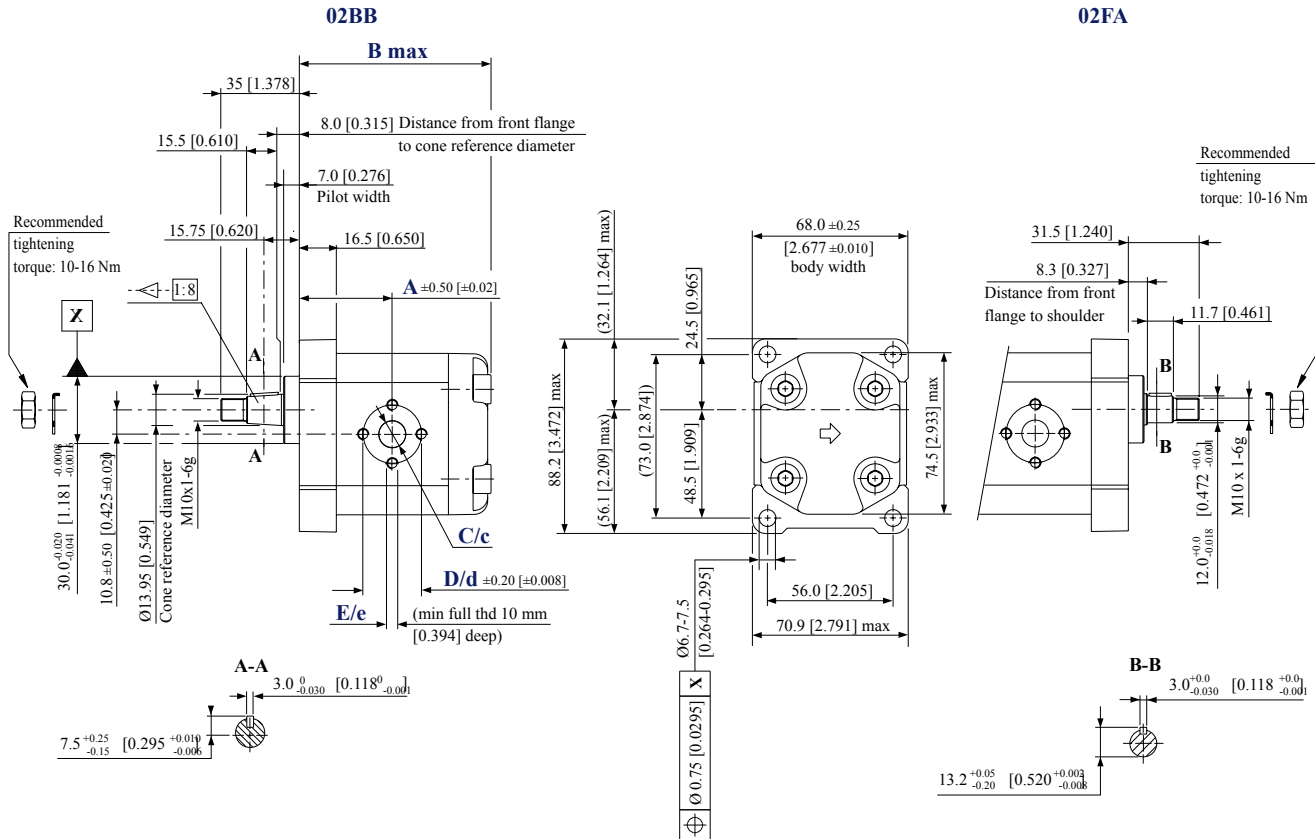

SKP1NN – 02BB and 02FA dimensions

Frame size		1,2	1,7	2,2	2,6	3,2	3,8	4,3	6,0	7,8	010	012
Dimension	A	37.75 [1.486]	38.5 [1.516]	39.5 [1.555]	40.5 [1.634]	41.5 [1.634]	42.5 [1.673]	43.5 [1.713]	46.75 [1.841]	50.0 [1.969]	54.5 [2.146]	58.5 [2.303]
	B	79.5 [3.130]	81.0 [3.189]	83.0 [3.268]	85.0 [3.346]	87.0 [3.425]	89.0 [3.504]	91.0 [3.583]	97.5 [3.839]	104.0 [4.094]	113.0 [4.449]	121.0 [4.764]
Inlet/Outlet	C/c	12 [0.472]										
	D/d	26 [1.024]										
	E/e	M5										

Model code examples and maximum shaft torque

Flange/drive gear	Model code example	Maximum shaft torque
02BB	SKP1NN/6,0RN02BBP1C2C2NNNN/NNNN	50 N•m [442 lb•in]
02FA	SKP1NN/ 2,2LN02FAP1C2C2NNNN/NNNN	24 N•m [212 lb•in]

For further details on ordering, see [Model code](#).

Dimensions

SNP1NN – 03CA

This drawing shows the standard porting for 03CA.

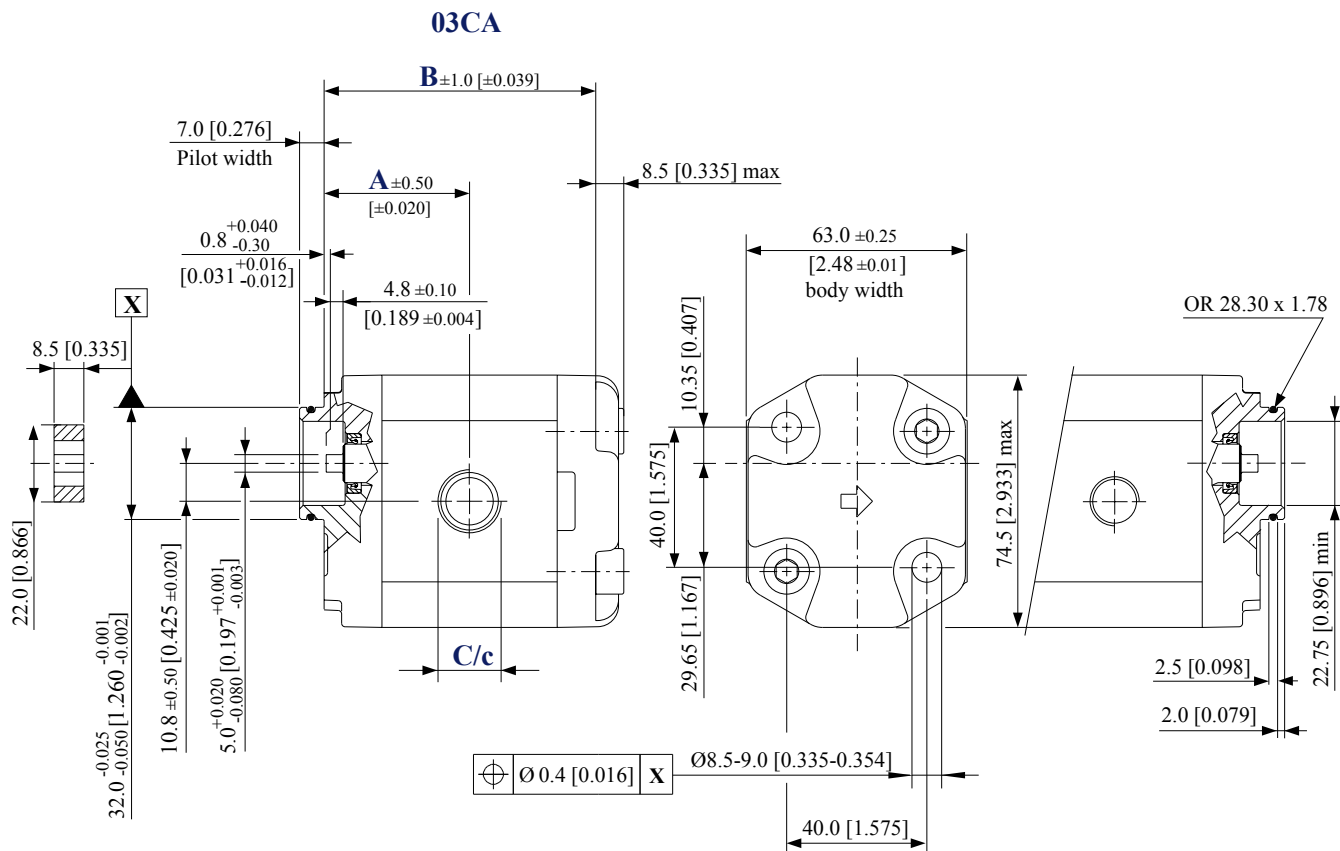

SNP1NN – 03CA dimensions

Frame size	1,2	1,7	2,2	2,6	3,2	3,8	4,3	6,0	7,8	
Dimension	A	37.75 [1.486]	38.5 [1.516]	39.5 [1.555]	40.5 [1.634]	41.5 [1.634]	42.5 [1.673]	43.5 [1.713]	46.75 [1.841]	50 [1.969]
	B	70 [2.756]	71.5 [2.815]	73.5 [2.894]	75.5 [2.972]	77.5 [3.051]	79.5 [3.130]	81.5 [3.209]	88.0 [3.465]	94.5 [3.720]
Inlet	C	M18 x 1.5 THD 12 [0.472] deep								
Outlet	c	M14 x 1.5, THD 12 [0.472] deep				M18 x 1.5, THD 12 [0.472] deep				

Model code examples and maximum shaft torque

Flange/drive gear	Model code example	Maximum shaft torque
03CA	SNP1NN/1,7RN03CA03D5D3NNNN/NNNN	14 N·m [124 lb·in]

For further details ordering, see [Model code](#).

Dimensions

SKP1NN – 06GA and 06SA

This drawing shows the standard porting for 06GA and 06SA. Available in Series SKP1NN only.

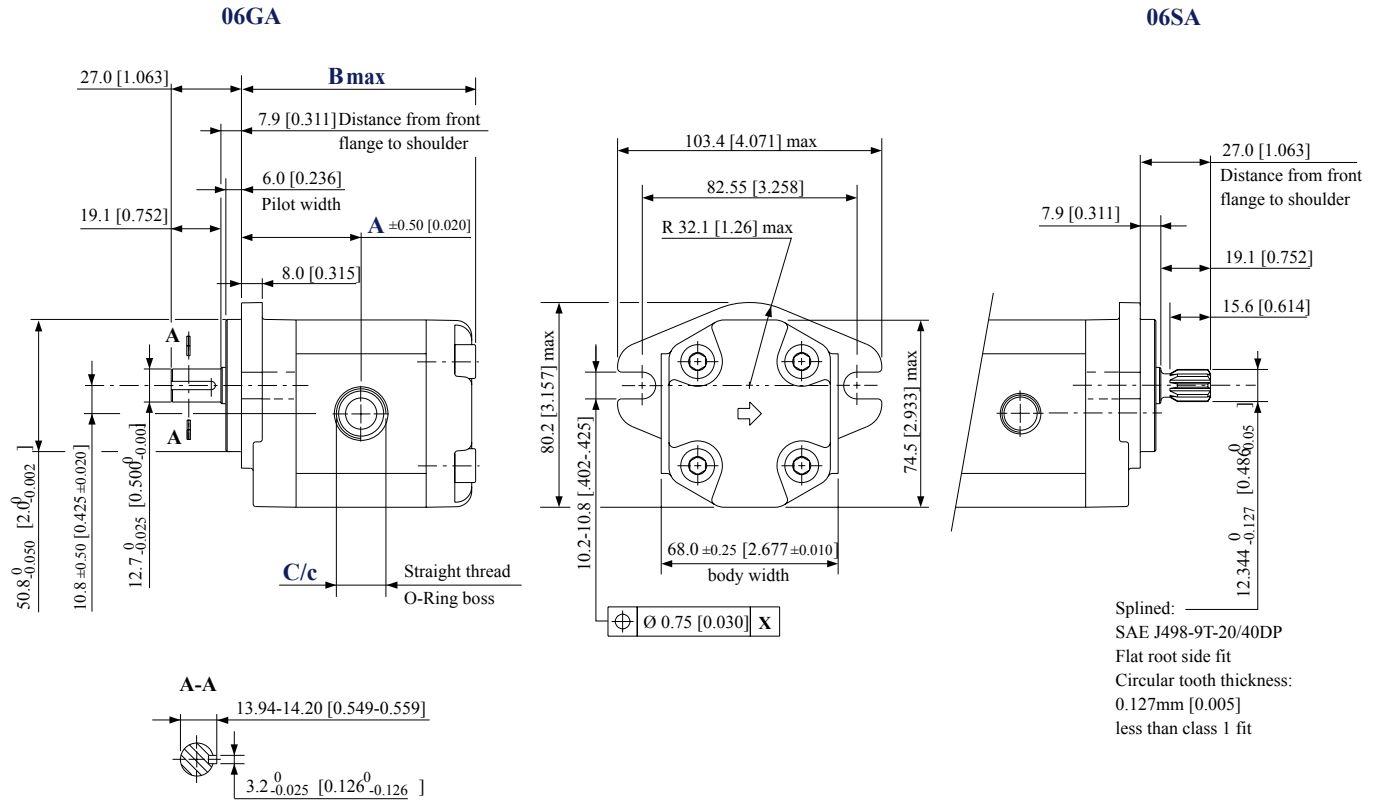

SKP1NN – 06GA and 06SA dimensions

Frame size		1,2	1,7	2,2	2,6	3,2	3,8	4,3	6,0	7,8	010	012
Dimension	A	42.25 [1.663]	43 [1.693]	44 [1.732]	45.0 [1.772]	46.0 [1.811]	47 [1.850]	48 [1.890]	51.25 [2.018]	54.5 [2.146]	59 [2.323]	63.5 [2.50]
	B	84 [3.307]	85.5 [3.366]	87.5 [3.445]	89.5 [3.524]	91.5 [3.602]	93.5 [3.681]	95.5 [3.760]	102 [4.016]	108.5 [4.272]	117.5 [4.626]	125.5 [4.941]
Inlet	C	¾–16UNF–2B, THD 14.3 [0.563] deep										
Outlet	c	9/16–18UNF–2B, THD 12.7 [0.500] deep										

Flange/drive gear	Model code example	Maximum shaft torque
06GA	SKP1NN/3,2RN06GAP1E4E3NNNN/NNNN	32 N•m [283 lb•in]
06SA	SKP1NN/012LN06SAP1E4E3NNNN/NNNN	34 N•m [301 lb•in]

For further details on ordering, see [Model code](#).

Products we offer:

- Cartridge valves
- DCV directional control valves
- Electric converters
- Electric machines
- Electric motors
- Gear motors
- Gear pumps
- Hydraulic integrated circuits (HICs)
- Hydrostatic motors
- Hydrostatic pumps
- Orbital motors
- PLUS+1® controllers
- PLUS+1® displays
- PLUS+1® joysticks and pedals
- PLUS+1® operator interfaces
- PLUS+1® sensors
- PLUS+1® software
- PLUS+1® software services, support and training
- Position controls and sensors
- PVG proportional valves
- Steering components and systems
- Telematics

Danfoss Power Solutions is a global manufacturer and supplier of high-quality hydraulic and electric components. We specialize in providing state-of-the-art technology and solutions that excel in the harsh operating conditions of the mobile off-highway market as well as the marine sector. Building on our extensive applications expertise, we work closely with you to ensure exceptional performance for a broad range of applications. We help you and other customers around the world speed up system development, reduce costs and bring vehicles and vessels to market faster.

Danfoss Power Solutions – your strongest partner in mobile hydraulics and mobile electrification.

Go to www.danfoss.com for further product information.

We offer you expert worldwide support for ensuring the best possible solutions for outstanding performance. And with an extensive network of Global Service Partners, we also provide you with comprehensive global service for all of our components.

Local address:

Hydro-Gear

www.hydro-gear.com

Daikin-Sauer-Danfoss

www.daikin-sauer-danfoss.com

**Danfoss
Power Solutions (US) Company**
2800 East 13th Street
Ames, IA 50010, USA
Phone: +1 515 239 6000

**Danfoss
Power Solutions GmbH & Co. OHG**
Krokamp 35
D-24539 Neumünster, Germany
Phone: +49 4321 871 0

**Danfoss
Power Solutions ApS**
Nordborgvej 81
DK-6430 Nordborg, Denmark
Phone: +45 7488 2222

**Danfoss
Power Solutions Trading
(Shanghai) Co., Ltd.**
Building #22, No. 1000 Jin Hai Rd
Jin Qiao, Pudong New District
Shanghai, China 201206
Phone: +86 21 2080 6201

Danfoss can accept no responsibility for possible errors in catalogues, brochures and other printed material. Danfoss reserves the right to alter its products without notice. This also applies to products already on order provided that such alterations can be made without subsequent changes being necessary in specifications already agreed. All trademarks in this material are property of the respective companies. Danfoss and the Danfoss logotype are trademarks of Danfoss A/S. All rights reserved.